



Ultra Low Temperature Freezers

Revco RLE series, Forma 89000
series, HERAfreeze HLE series and
Thermo Scientific TLE series

Installation and Operation

328398H01

Rev. H

April 2019

Visit us online to register your warranty
www.thermofisher.com/labwarranty



thermo scientific

IMPORTANT Read this instruction manual. Failure to follow the instructions in this manual can result in damage to the unit, injury to operating personnel, and poor equipment performance.

CAUTION All internal adjustments and maintenance must be performed by qualified service personnel.

Material in this manual is for informational purposes only. The contents and the product it describes are subject to change without notice. Thermo Fisher Scientific makes no representations or warranties with respect to this manual. In no event shall Thermo be held liable for any damages, direct or incidental, arising from or related to the use of this manual.

© 2019 Thermo Fisher Scientific Inc. All rights reserved.

Contents

Models	1
Safety Precautions	2
Unpacking	4
Packing List	5
General Recommendations	6
Temperature Monitoring	6
General Usage	6
Initial Loading.....	6
Battery Door Opening / Closing	7
Operating Standards	8
Electrical Specifications.....	8
Installation	9
Location	9
Wiring	9
Leveling	10
Backup System (Optional).....	10
Super Insulated Cabinet Construction.....	10
Door Operation	10
Pressure Equalization Port	12
Installing the Remote Alarm Connector	12
Intended Use	13
Start Up	14
Connectivity Requirements.....	14
Initial Start Up.....	16
Standby Mode	28
Operation	29
Operation Overview	29
Home Screen	29
Settings.....	30
Event Log.....	42
Alarms	44
Users.....	45
Reports	48
Chart.....	49
Health Status and Alarm Management	53
Health Status Overview	53
Notifications / Cautions	55
Alarms / Warning.....	56

Backup System (Optional)	57
CO2 and LN2 Precautions	57
Installation.....	58
Start Up	59
Operation.....	59
Chart Recorders (Optional)	60
Set Up and Operation	60
Changing Chart Paper	61
Calibration Adjustment	61
Maintenance	62
Cleaning the Condenser	62
Cleaning the Condenser Filter.....	62
Gasket Maintenance	62
Defrosting the Freezer.....	63
Battery Maintenance	63
Maintenance Schedule	64
Troubleshooting Guide	65
Connectivity Troubleshooting	69
Warranty	71
Warranty (International)	72
Appendix A: Alarm Summary	73
Appendix B: Event Log Detail	80
Appendix C: City Time Zone	82

1 Models

Brand - Model	Size (xxx)	Voltage (*)
Forma - 89xxx86*	300 / 400 / 500 /d 600	A / D / V
Thermo Scientific –TLExxx86*	300 / 400 / 500 / 600	A / D / V
HERAfreeze –HLExxx86*	300 / 400 / 500 / 600	A / D / V
Revco -RLExxx86*	300 / 400 / 500 / 600	A / D / V

** Note: Energy Star is not applicable to models of size 300 / 400 and voltage of 'V' models.*

2 Safety Precautions

In this manual, the following symbols and conventions are used:



This symbol used alone indicates important operating instructions which reduce the risk of injury or poor performance of the unit.



CAUTION: This symbol, in the context of a CAUTION, indicates a potentially hazardous situation which if not avoided could result in minor to moderate injury or damage to the equipment.



WARNING: This symbol indicates potentially hazardous situations which, if not avoided, could result in serious injury or death.



WARNING: This symbol indicates situations where dangerous voltages exist and potential for electrical shock is present.



The snowflake symbol indicates extreme low temperatures and high risk of frostbite. Do not touch bare metal or samples with unprotected body parts.



This symbol indicates a need to use gloves during the indicated procedures. If performing decontamination procedures, use chemically resistant gloves. Use insulated gloves for handling samples and when using liquid nitrogen.



Before installing, using or maintaining this product, please be sure to read this manual and product warning labels carefully. Failure to follow these instructions may cause this product to malfunction, which could result in injury or damage.

Below are important safety precautions that apply to this product:



Use this product only in the way described in the product literature and in this manual. Before using it, verify that this product is suitable for its intended use. If this equipment is used in a manner not specified by the manufacturer, the protection provided by the equipment may be impaired.



Do not modify system components, especially the controller. Use OEM exact replacement equipment or parts. Before use, confirm that the product has not been altered in any way.



WARNING: Your unit must be properly grounded in conformity with national and local electrical codes. Never connect the unit to overloaded power sources.



WARNING: Disconnect the unit from all power sources before cleaning, troubleshooting, or performing other maintenance on the product or its controls.



WARNING: “Caution, risk of fire”. This unit is charged with hydrocarbon refrigerants.

3 Unpacking

At delivery, examine the exterior for physical damage while the carrier's representative is present. If exterior damage is present, carefully unpack and inspect the unit and all accessories for damage.

If there is no exterior damage, unpack and inspect the equipment within five days of delivery. If you find any damage, keep the packing materials and immediately report the damage to the carrier. Do not return goods to the manufacturer without written authorization. When submitting a claim for shipping damage, request that the carrier inspect the shipping container and equipment.

4 Packing List

Inside the freezer cabinet is a bag containing:

- This manual
- A handle lock key
- USB drive with user's manuals, including translated versions
- Certificates of conformance and calibration
- A remote alarm contact connector
- Posts for rear spacing

If you have ordered a field-installed chart recorder, the bag will also contain:

- Recorder installation instructions
- Extra ink less paper

If you have ordered a backup system, the cabinet will also contain:

- A hose assembly
- English and metric connectors

If specified on the order, the bag may also include:

- A QC temperature graph and test log
- Calibration information

If you have ordered the Proximity Access Card Option, the cards will be in a bag attached to the front of the freezer.

5 General Recommendations

5.1 Temperature Monitoring



IMPORTANT NOTE We recommend the use of a redundant and independent temperature monitoring system so that the freezer can be monitored continuously for performance commensurate with the value of product stored.

5.2 General Usage

This refrigeration system is designed to maintain ultra-low temperatures with safety in an ambient environment within 15°C to 32°C (59°F to 90°F), only when the freezer is used for storage.



WARNING: This unit is not a “rapid-freeze” device. Freezing large quantities of liquid, or high-water content items, will temporarily increase the chamber temperature and will cause the compressors to operate for a prolonged time period.

Avoid opening the door for extended time periods since chamber temperature air will escape rapidly. Also, keep the inner doors closed as much as possible. When room air, which is higher in humidity, replaces chamber air, frost may develop in the chamber more rapidly.

5.3 Initial Loading

Allow the freezer to operate at the desired temperature for a minimum of 12 hours before loading.

Load the freezer one shelf at a time, beginning with the top shelf. After loading each shelf, allow the freezer to recover to the desired set point before loading the next shelf. Repeat this process until the freezer is fully loaded.



CAUTION: Failure to follow these procedures or overloading the unit may cause undue stress on the compressors or jeopardize user product safety.

5.4 Battery Door Opening / Closing

To open the grille door, pull the door from the top right corner as shown in the figure below.

To close the grille door, push the door against frame to hold latch in position.



Figure 1. Door Opening

6 Operating Standards

The freezers described in this manual are classified for use as stationary equipment in a Pollution Degree 2 and Over voltage Category II environment.

These units are designed to operate under the following environmental conditions:

- Indoor use
- Altitude up to 2000 m
- Maximum relative humidity 60% for temperatures within 15°C to 32°C (59°F to 90°F).
- Main supply voltage fluctuations not to exceed ±10% of the nominal voltage.

6.1 Electrical Specifications

The last character in the model number listed on the data-plate identifies the electrical specifications for your unit. Specific unit current rating is listed on the data-plate.

The voltage types are A, D and V as specified in the following table:

Table 1. Revco RLE series, Forma 89000 series, HERAfreeze HLE series and Thermo Scientific TLE series Electrical Specifications

Model	Voltage	Frequency	Current
300A	115 V	60 Hz	12.6 A
300D	208-230 V	60 Hz	5.6 A
300V	230 V	50 Hz	5.9 A
400A	115 V	60 Hz	13.0 A
400D	208-230 V	60 Hz	5.9 A
400V	230 V	50 Hz	5.3 A
500A	115 V	60 Hz	12.5 A
500D	208-230 V	60 Hz	5.0 A
500V	230 V	50 Hz	5.9 A
600A	115 V	60 Hz	12.7 A
600D	208-230 V	60 Hz	6.2 A
600V	230 V	50 Hz	6.1 A

7 Installation



WARNING: Do not exceed the electrical rating printed on the data plate located on the lower left side of the unit.

7.1 Location

Install the unit in a level area free from vibration with a minimum of 8 inch (20 cm) of space on the top and sides, 6 inch (15 cm) in back. Refer to Section 7.3 for further instructions on leveling cabinets. Allow enough clearance so that door can swing open at least 85°.

The rear spacing posts provided with the freezer can be used to ensure proper clearance. To install the spacing posts, screw them into the back in the rear deck area.

Do not position the equipment in direct sunlight or near heating diffusers, radiators, or other sources of heat. The ambient temperature range at the location must be 15°C to 32°C (59°F to 90°F).

7.2 Wiring



CAUTION: Connect the equipment to the correct power source. Incorrect voltage can result in severe damage to the equipment.



CAUTION: For personal safety and trouble-free operation, this unit must be properly grounded before it is used. Failure to ground the equipment may cause personal injury or damage to the equipment. Always conform to the National Electrical Code and local codes. Do not connect the unit to overloaded power lines.



CAUTION: Do not position the unit in a way that impedes access to the disconnecting device or circuit breaker in the back of the unit.



CAUTION: Always connect the freezer to a dedicated (separate) circuit. Each freezer is equipped with a service cord and plug designed to connect it to a power outlet which delivers the correct voltage. Supply voltage must be within $\pm 10\%$ of the freezer rated voltage.



CAUTION: Never remove or disable the grounding prong from the service cord plug. If the prong is removed, the warranty is invalidated.

7.3 Leveling

Make sure that the floor is level. The unit must be level both front to back and side to side.

300 and 400 box capacity models are equipped with one or two leveling legs on the right hand side. These may be used to help prevent the unit from shifting during a door opening.

Be certain to lock the brakes for units equipped with casters.

7.4 Backup System (Optional)

If you are using a CO₂ or LN₂ backup system, refer to Section 11 for installation and operation instructions.

7.5 Super Insulated Cabinet Construction

In all models, the cabinet walls have a vacuum insulation core encapsulated by a sealed film laminate.



CAUTION: Never drill holes in or near the cabinet walls. Drilling could damage the insulation and make the unit inoperable.

7.6 Door Operation

Upright freezer models are equipped with an advanced assembly specifically designed for ultra-low temperature freezers.

Features include:

- One-hand operation
- A front-accessible lock
- Hasps for a standard padlock to provide additional security. Length of the shackle must be between 3/4 inch (1.9 cm) and 1 1/2 inch (3.8 cm).
- Durable construction for reliable operation and safe product storage.
- Door ramp alignment feature
- Optional controlled access to the freezer with Proximity Access cards.



CAUTION: When moving the freezer, always grasp cabinet surfaces; never pull the freezer by the latch handle.

7.6.1 Opening the Door

For freezers with the Proximity Access Card option:

1. Remove the padlock if installed.

2. To unlock the door, pass the card in front of the freezer below the LCD display.
3. Grasp the latch handle and pull it toward yourself until the latch disengages from the cabinet strike.
4. Keep pulling by the latch handle to open the main door.

For freezers without the Access Card option:

1. Remove the padlock if installed.
2. Grasp the latch handle and pull it toward yourself until the latch disengages from the cabinet strike.
3. Keep pulling by the latch handle to open the main door.

7.6.2 Opening the Door During a Power Outage

In case of power outage and a unit that has the Proximity Access Card option, you may use a 9 volt battery to activate the system. To access the 9 volt terminal, remove the USB cover and locate the battery terminals.

Once the terminals are exposed, open the door by holding the 9 volt battery against the terminals and pass a valid proximity card below the display area. Once the door is open, remove the 9 volt battery.

Note: *The terminals are polarized therefore orient the 9 volt battery properly.*

7.6.3 Closing the Door

Note: *The latch does not self-engage automatically when you close the door. You must rotate the latch into the open position first.*

1. Grasp the latch handle (preferably with your left hand) and pull it toward yourself, rotating the latch into the open position.
2. Move the freezer door into the closed position and gently push the handle away from you, making sure that the latch engages fully with the cabinet strike.
3. Keep applying gentle pressure to the latch handle until the latch is securely in closed position.
4. Insert the key and rotate counterclockwise to lock.
5. Replace the padlock as required.

7.7 Pressure Equalization Port

When an upright ultra-low temperature freezer door is opened, room temperature air rushes into the storage compartment. When the door is closed, the fixed volume of air is cooled rapidly. Pressure drops below atmospheric pressure, resulting in a substantial vacuum. Re-entry into the cabinet is impossible until internal pressures are returned to atmospheric pressure. Without a pressure equalization mechanism, it can take, in extreme cases, several hours before the door can easily be reopened.

All upright models feature a port that provides vacuum relief after door openings. The pressure equalization port is located in the door behind the eye-level panel on the front of the freezer. Although the port is designed to self-defrost, excessive frost accumulation on the inner door could eventually restrict air flow. Therefore you should periodically inspect the inner door and brush away any loose frost using a stiff nylon brush.

7.8 Installing the Remote Alarm Connector

The remote alarm contacts are located on the back of the freezer above and to the left of the power switch. After installing the wiring from the remote alarm to the connector, install the connector to the freezer micro-board.

The pin configuration is shown in Figure 2 below.

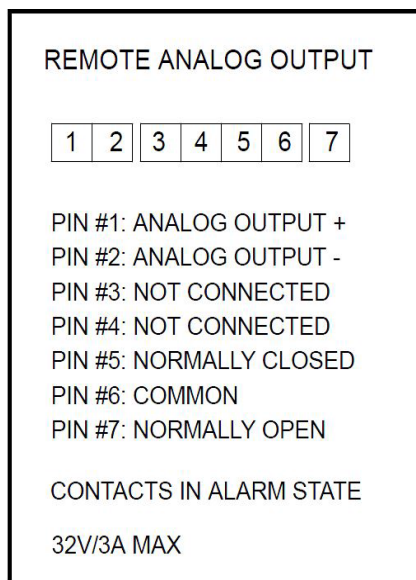

Figure 2. Remote Alarm Pin Configuration

The contacts will trip in the event of a power outage, high temperature alarm, low temperature alarm or door ajar alarm.

7.9 Intended Use

The -86°C freezer (refer to Section 1 for the specific model series) described in this manual are high performance units for professional use. These products are intended for use as cold storage in research use and as a general purpose laboratory freezer, storing samples or inventory at operating temperatures between -50°C and -80°C .

It is not considered a medical device and has therefore not been registered with a medical device regulatory body (e.g. FDA): that is, it has not been evaluated for the storage of samples for diagnostic use or for samples to be re-introduced to the body.

This unit is not intended for use in classified hazardous locations, nor to be used for the storage of flammable inventory.

8 Start Up

8.1 Connectivity Requirements

There are two requirements to take full advantage of your freezers connectivity options:

1. The freezer will need to be connected to a wireless network with internet connection, the freezer is only able to use a wireless connection.
 - a. Refer to WiFi Specification table in Section 8.1.1 for acceptable network security parameters.
 - b. Please speak with your local Information Technology (IT) group about the correct wireless network and password to use.
2. The individual monitoring the unit will need a Thermo Fisher Connect account and will need to link the unit to his/her account via InstrumentConnect™. To create a Thermo Fisher Connect account:
 - a. Use a web browser to open the following URL: <https://apps.thermofisher.com>
 - b. Choose "Create an Account" and follow the instructions to establish a new account. (Remember your login information for later use.)
 - c. (Optional) Download the InstrumentConnect mobile/tablet application from the AppStore or PlayStore.

Note: *InstrumentConnect™ is the section of Thermo Fisher Connect where all connected instruments can be monitored. To access this section, click on the InstrumentConnect icon indicated below.*

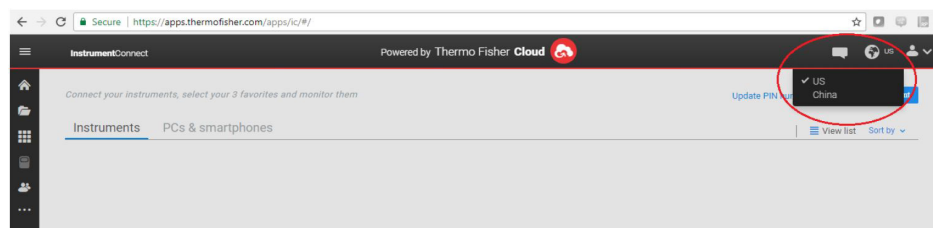
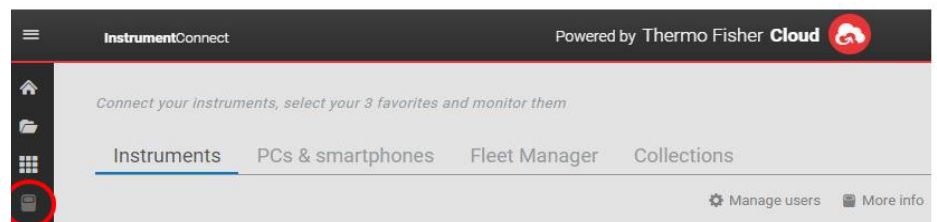

Note: *If you are a user in China, the web client allows you to switch to that region after logging in or you can log in directly to the China environment by using <https://china.apps.thermofisher.com>.*

8.1.1 Specifications

Table 2. Specifications

Parameter	Specification
Default Wi-Fi transmission frequency to the cloud	Every 5 minutes for sensor data transmission. Real-time for alarm events
WiFi protocol	2.4 GHZ Only: IEEE 802.11B, IEEE 802.11G, IEEE 802.11N
Wi-Fi Security	WPA / WPA2PSK WPA / WPA2EAP PEAP Proxy Servers are not supported.
Wi-Fi Data Rate	Minimum of 1 Mbps
Wi-Fi Range	Up to 30 meters
Minimum Required Wireless Signal	-70 dbM
Firewall Ports that must open	80, 123, 443

Note: *Thermo Fisher Scientific connected devices do not support the use of proxy servers or enterprise networks which require identity/username for internet access.*

8.1.2 In case of Failure

If your freezer is unable to connect to either a wireless network or a cloud account, please verify your name and password, and attempt to re-connect.

If issues persist, please contact Your Local Support.

Note: *If your network password expires or changes, your freezer will no longer connect automatically. Be sure to manually update your password in the freezer user interface settings to reconnect. Failure to reconnect within 3 days will result in data loss.*

8.2 Initial Start Up

To start up the freezer, complete the following steps:

1. Plug the freezer into the power outlet.
2. Turn the power switch in back of the freezer, on the bottom right, to the ON position.
3. Once the freezer is powered up, the Thermo Scientific logo is displayed on the front screen. If this is the first time the unit is being turned on, an initial setup must be completed. Press the Start Setup button to initiate the setup.



Figure 3. Main Screen

The first step of the setup is to select the language. This screen allows you to specify the preferred display language. Once the language is selected, press the Next button.

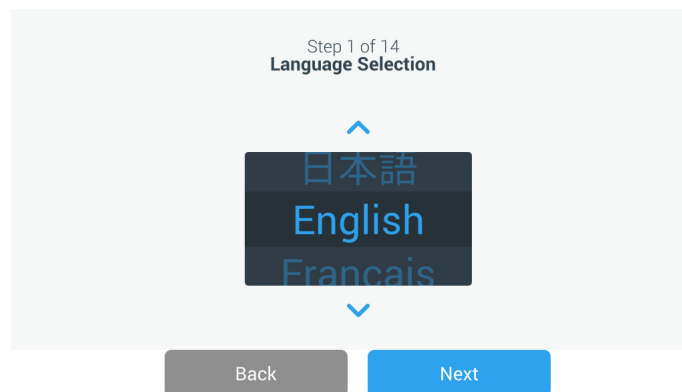

Figure 4. Language Selection Screen

The next screen allows you to select your location. Enter the name of the city and select from the list of suggestions displayed.

After selecting the region, press the Next button.

Step 2 of 14
Region Setup

Country

Enter the city closest to your time zone

City

- Abidjan (Africa | +00:00)
- Accra (Africa | +00:00)
- AddisAbaba (Africa | +03:00)
- Algiers (Africa | +01:00)

Back Next

Figure 5. Region Setup Screen

When entering your “City” into Region Setup screen, refer to *“Appendix C: City Time Zone”*. Follow the table to select the city closest to your time zone.

The next screen allows you to identify an individual freezer by specifying a Unit Name. After entering a name, press the Next button.

Step 3 of 16
Unit Name Setup

Unit Name

Back Next

Figure 6. Unit Name Setup Screen

The next few screens allow you to setup a wireless connection to store information on InstrumentConnect.™

To fully connect your new unit, you will need to:

1. Connect the unit to a wireless network allowing data to be sent to Thermo Fisher Connect.
2. Log in to Thermo Fisher Connect (web or app) and link the unit to your account via InstrumentConnect.

Note: Before you begin, establish a Thermo Fisher Connect account and have your network login information available. Refer to section Section 8.1 for details.

The first screen requires acceptance of the terms and conditions of using connectivity on this device.

If you chose to Skip this acceptance, Wi-Fi connectivity will be disabled. You will be able to accept the terms and enable connectivity at a later time via the Connectivity settings menu.

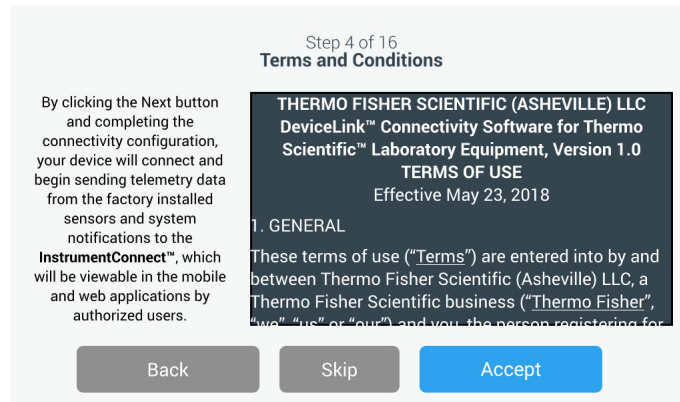

Figure 7. Terms and conditions screen

Select a wireless network and press the Next button.

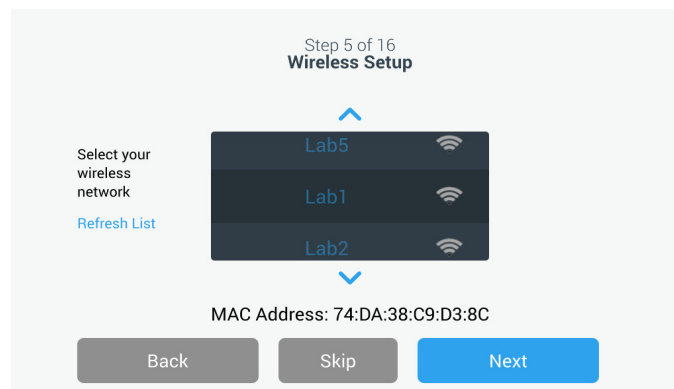

Figure 8. Wireless Setup Screen

Once the intended network is selected (highlighted), you must press the Next button.

Note: If you do not want to setup a wireless connection, press the Skip button. The Date and Time Setup screens will appear. To setup a wireless connection later, press the Settings menu icon and select Connectivity.

Enter the network password and press the Next button.

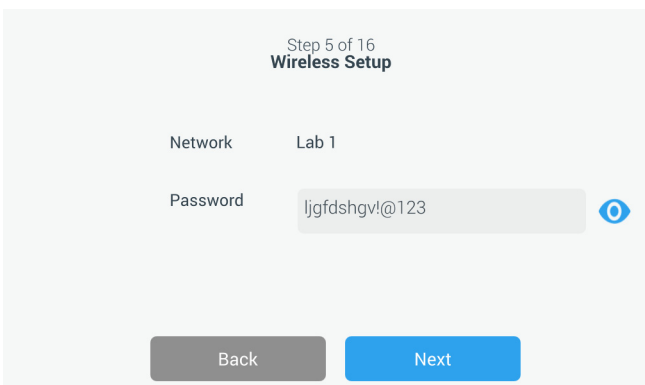



Figure 9. Wireless Setup (Password) Screen

Note: Press the eye icon  on the screen for password visibility

Note: The on-screen keyboard does not support all special characters. Please inquire with your local IT group for assistance with password reset to accommodate allowable character entry.

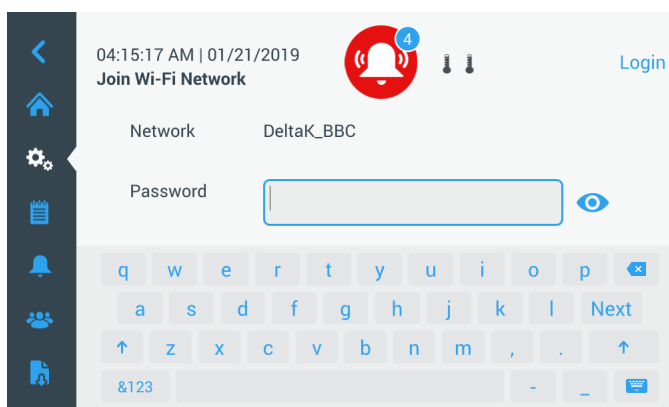

Figure 10. On Screen Key board

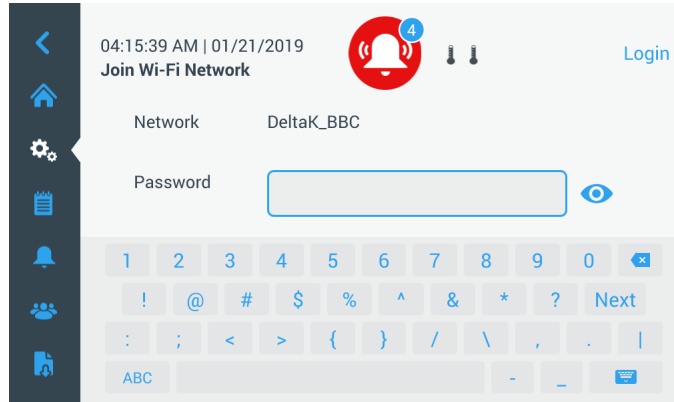

Figure 11. On Screen Key-board

A success message is displayed once the connection is established. If the connection fails, either due to an incorrect Wi-Fi password or network unavailability, a general error message is displayed. After 5 seconds, the interface will return to the previous screen.

If this occurs, check the network status and re-enter the correct password to establish the connection. (Tip: use the eye icon to verify the password entry before attempting connection.)

Refer to Section 15 for more connectivity troubleshooting.

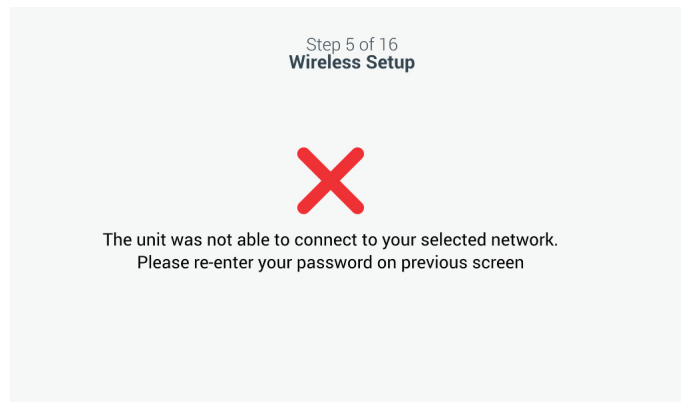

Figure 12. Wireless Setup Error Message Screen

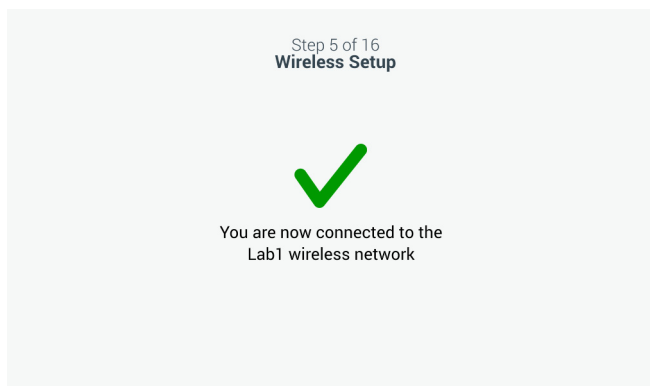

Figure 13. Wireless Setup Success Message Screen

The Network Configuration screen appears after a successful connection is established, which displays the time and date based on the wireless network. Verify the information displayed and press the Next button.

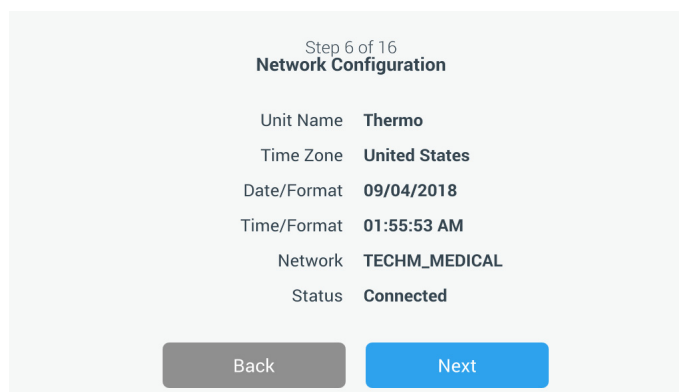

Figure 14. Network Configuration Screen

The next screen displays three options to connect your unit to InstrumentConnect. You can store historical data and receive alarm notifications to your InstrumentConnect account.

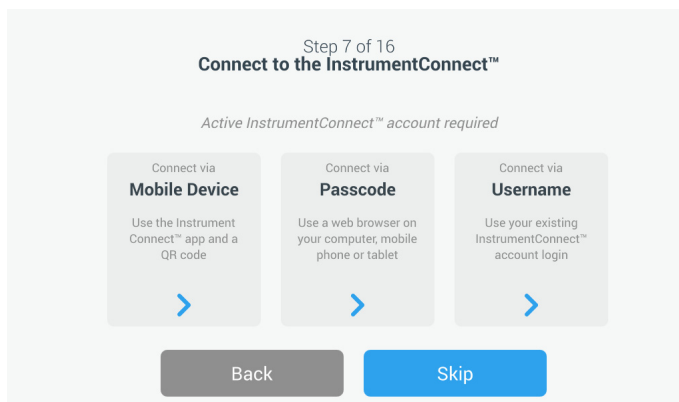

Figure 15. Connect to the InstrumentConnect Screen

Connect via Mobile Device

Selecting the Connect via Mobile Device option displays the following screen. Follow the instructions to connect to InstrumentConnect.

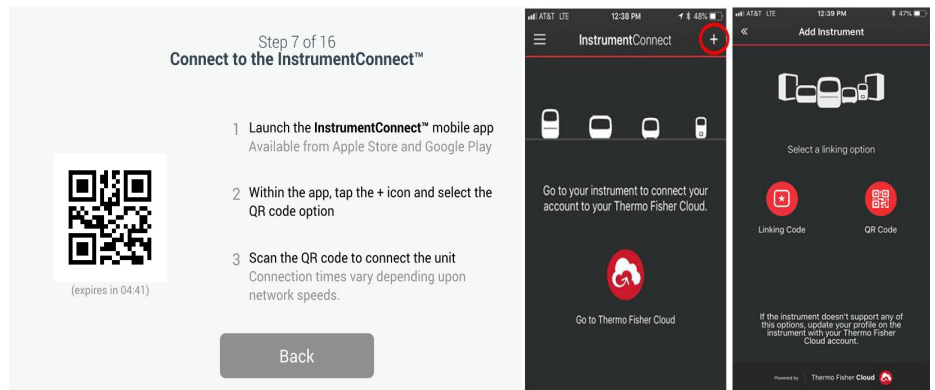

Figure 16. Connect to the InstrumentConnect (via Mobile Device) Screen and Mobile Device Screens

Connect via Passcode

This option displays a code that has to be entered to connect to InstrumentConnect.

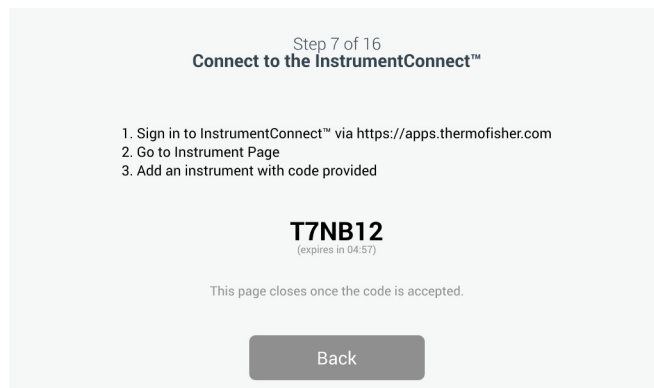

Figure 17. Connect to the InstrumentConnect (via Passcode) Screen

Connect via user name

Sign in using your InstrumentConnect user name and password and press the Link Account button.

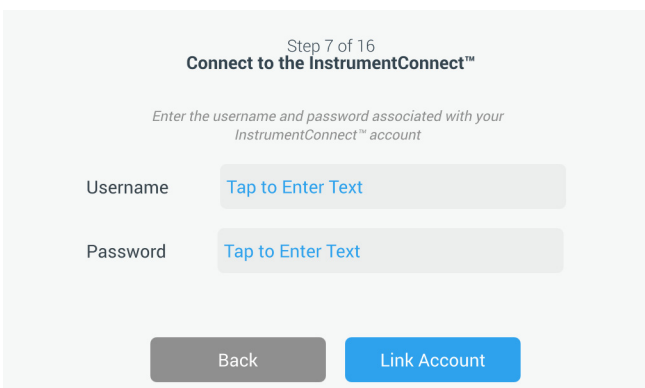

Figure 18. Connect to the InstrumentConnect (via user name) Screen

If the connection is successful via any of the three methods, a success message is displayed.

Note: *If a connection is established, and you choose to connect the unit with additional user InstrumentConnect accounts, you can press the Back button and repeat the same process. If you go back and then decide not to continue an additional connection setup you will need to press the Skip button on the connection screen (See Figure 15). This will not remove any established connections previously created. You can also add additional connections via the Connection Settings menu after initial start-up is complete.*

If the connection is unsuccessful, an error message is displayed. After 5 seconds, the interface will return to the previous screen. Check the network status and any entered passwords, etc. and repeat the previous steps to establish a successful unit connection.

Refer to Section 15 for more connectivity troubleshooting.

The next screen allows you to specify the temperature unit. After selecting the unit, tap the Next button.

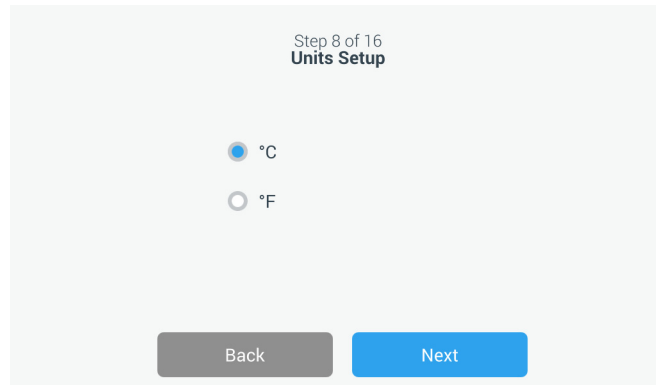

Figure 19. Units Setup Screen

The next three screens provide installation instructions.

The first screen provides information regarding power source and ambient temperature conditions. Press the Next button to continue through the installation instructions.

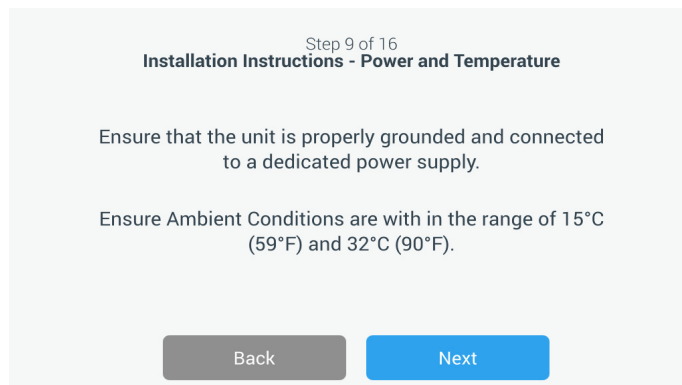

Figure 20. Installation Instructions (Power and Temperature) Screen

The second screen provides information regarding unit positioning, spacing and leveling. Press the Next button after reviewing.

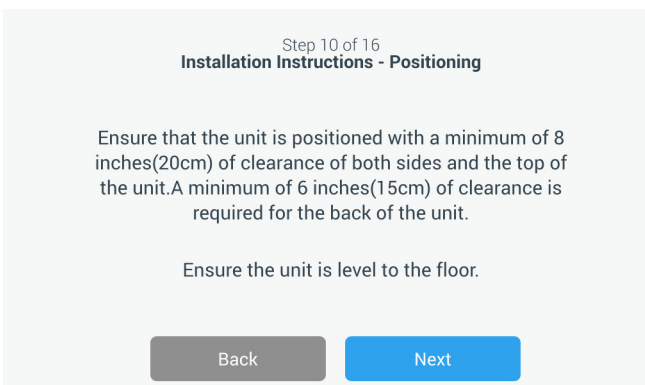

Figure 21. Installation Instructions (Positioning) Screen

The third screen provides information regarding initial freezer loading. Press the Next button after reviewing.

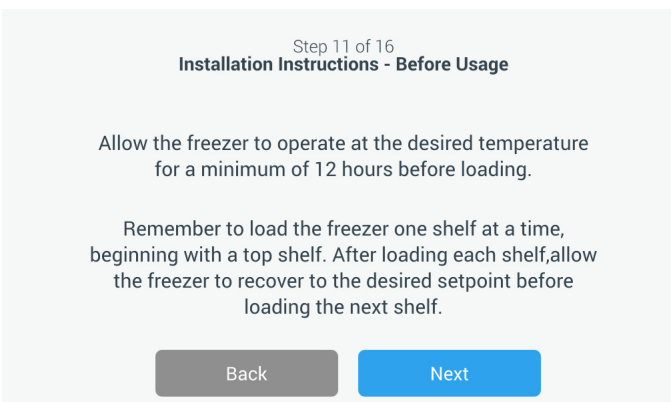

Figure 22. Installation Instructions (Before Usage) Screen

The next screen allows you to specify the temperature, warm and cold alarm set points. After setting the temperatures, press the Next button.

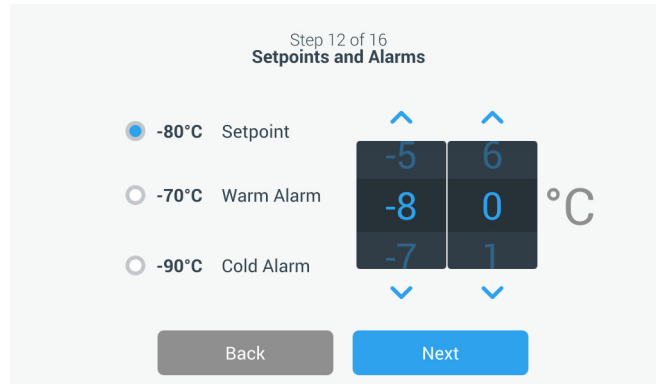

Figure 23. Setpoints and Alarms Screen

This screen allows you to select the Operating Mode. Once the mode has been selected, press the Next button.

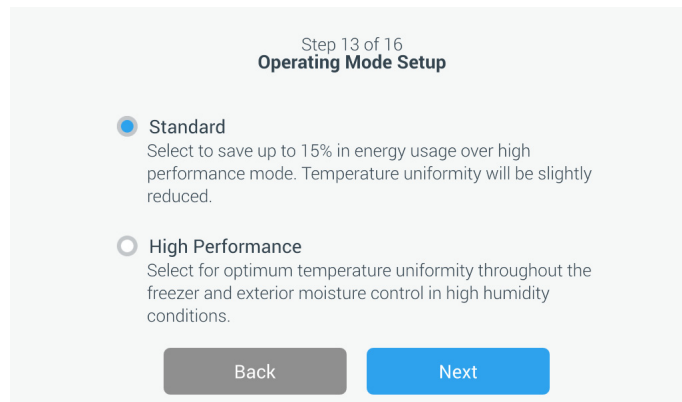

Figure 24. Operating Mode Setup Screen

This screen allows you to specify the Access Mode.

Step 14 of 16
Access Mode Setup

Full Access
Select to allow full access to all functionality for all users

Secured Access
Select to enable setpoint security through username and password profiles. All for three types of profiles.

Administrator: Access to change settings and manage profiles.	User Level 1: Access to change basic functionality (i.e. temperature and alarm setpoints)	User Level 2: View freezer temperature and alarm information, no ability to change settings.
---	---	--

Back
Next

Figure 25. Access Mode Setup Screen

If Secured Access is selected, at least one administrative account will need to be created.

This screen allows you to enter the details of your first name, last name, email and user name in the access mode set-up screen

Step 15 of 16
Access Mode Setup

First Name •

Last Name •

Email • +

User Name •

Back
Next

Figure 26. Access Mode Setup Screen

This screen indicates your initial setup is complete. Press the Finish button to complete initial setup or the Back button to make changes.

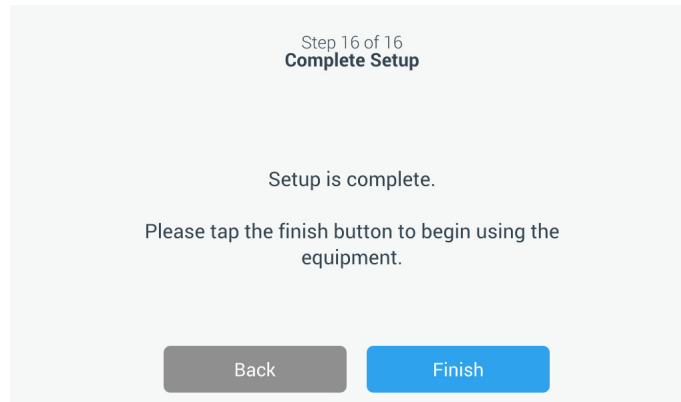

Figure 27. Complete Setup Screen

8.3 Standby Mode

There is a standby button on the front of the unit. When pressed and held for ~3 seconds the user will be prompted to confirm that the unit should be placed in standby mode. Upon confirmation, the unit will enter standby mode. The refrigeration system will be shut down and the unit will not cool while in standby mode. To exit standby mode and restore normal operation, the standby power button must be pressed and held for ~1 second.

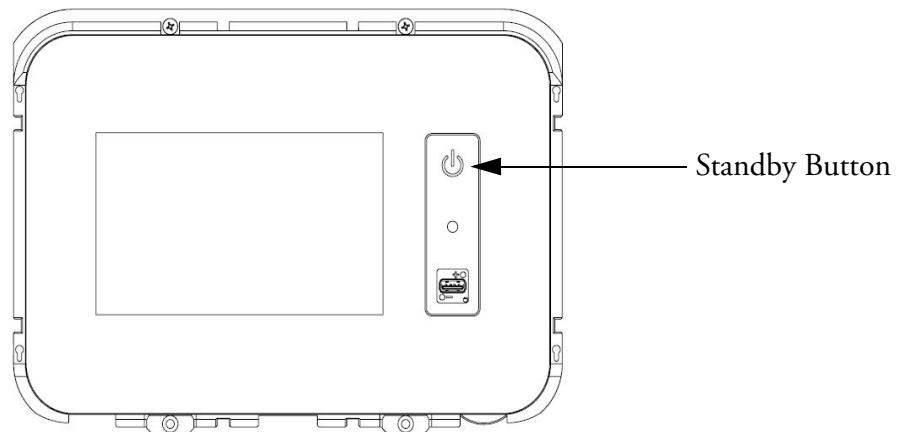

Figure 28. Standby Button

9 Operation

9.1 Operation Overview

Once you have successfully completed the initial start up procedures, the freezer starts operating normally and the only actions required are:

- Setting the operating and alarm set points, refer to Section 9.3.1.
- Activating the CO₂ or LN₂ backup system if installed. For instructions on backup settings and activating the system, refer to Section 11.

9.2 Home Screen

The Home Screen below is the default screen.

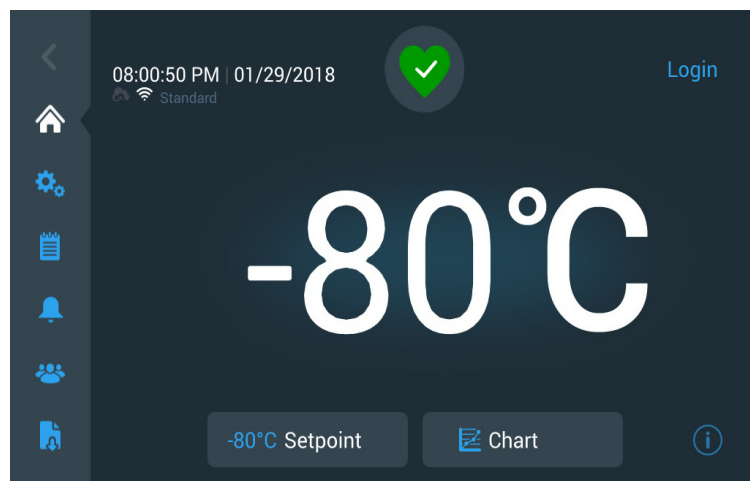

Figure 29. Home Screen

The various options available on the home screen are:

- The vertical panel on the left is the navigation bar that provides access to all functions of the unit.
- The colored icon in the middle indicates the health of the unit. There are four icons to denote this:
 - Green heart with a check mark indicates operation is normal
 - Yellow triangle with an exclamation mark indicates a notification
 - Red bell indicates an alarm condition
 - Red bell with a diagonal indicates the alarm has been snoozed
- A login button to login into the system. Refer to Section 9.2.1 for more information.

- The icons displayed below the time indicate if the unit is connected to InstrumentConnect and Wi-Fi, signal strength, and the operating mode.
- The set point temperature is displayed. This can be changed by pressing the Set point button at the bottom of the screen.
- The temperature chart can be viewed by pressing the Chart button at the bottom of the screen. Refer to Section 9.8 for more information.
- The “i” icon at the bottom right corner of the screen is the on board help button. Press this icon to display an inboard help box with text explaining all of the features available on that particular screen.
- The back button to navigate to the previous screen.

9.2.1 User Login

When the system is in Secured Access Mode, the user has to login by entering their user name and password.

When the system is running in Full Access mode, the login feature is restricted to service technicians to access the Service screens.

9.3 Settings

The second tab on the navigation panel is the Settings icon. The following screen will be displayed once the Settings icon is pressed:

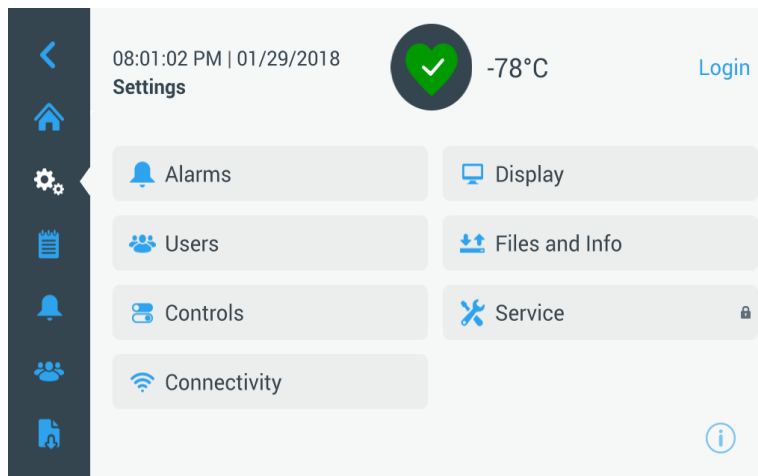

Figure 30. Settings Screen

9.3.1 Alarms The Alarm Settings screen provides the option to set the warm and cold alarm set points. Press the Warm Alarm or Cold Alarm button and the Setpoints screen will be displayed permitting parameter adjustments. For more information, refer to Section 9.3.5.

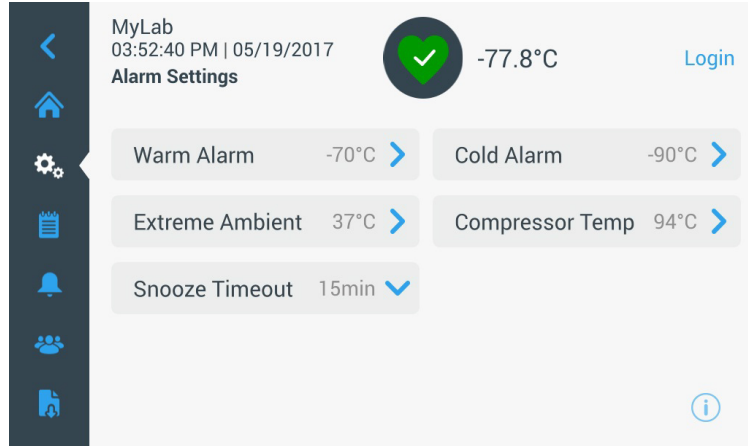

Figure 31. Alarm Settings Screen

- **Warm Alarm:** The range of the warm alarm temperature is -40°C to within 5°C of set point.

Note: *The warm alarm will be disabled for 12 hours from a warm start condition.*

- **Cold Alarm:** The range is -99°C to within 5°C of set point.
- **Extreme Ambient:** This allows the user to set the extreme ambient alarm set point. The range is 32°C to 40°C . Default is 37°C .
- **Compressor Temp:** It is an alarm set point for the second stage compressor sump temperature. The range is 70°C to 98°C . Default is 94°C .
- **Snooze Timeout:** This sets the time to snooze the audible alarm for an active alarm.

9.3.2 Display From the Settings screen, pressing the Display button will show the Display screen. Various display settings can be adjusted.

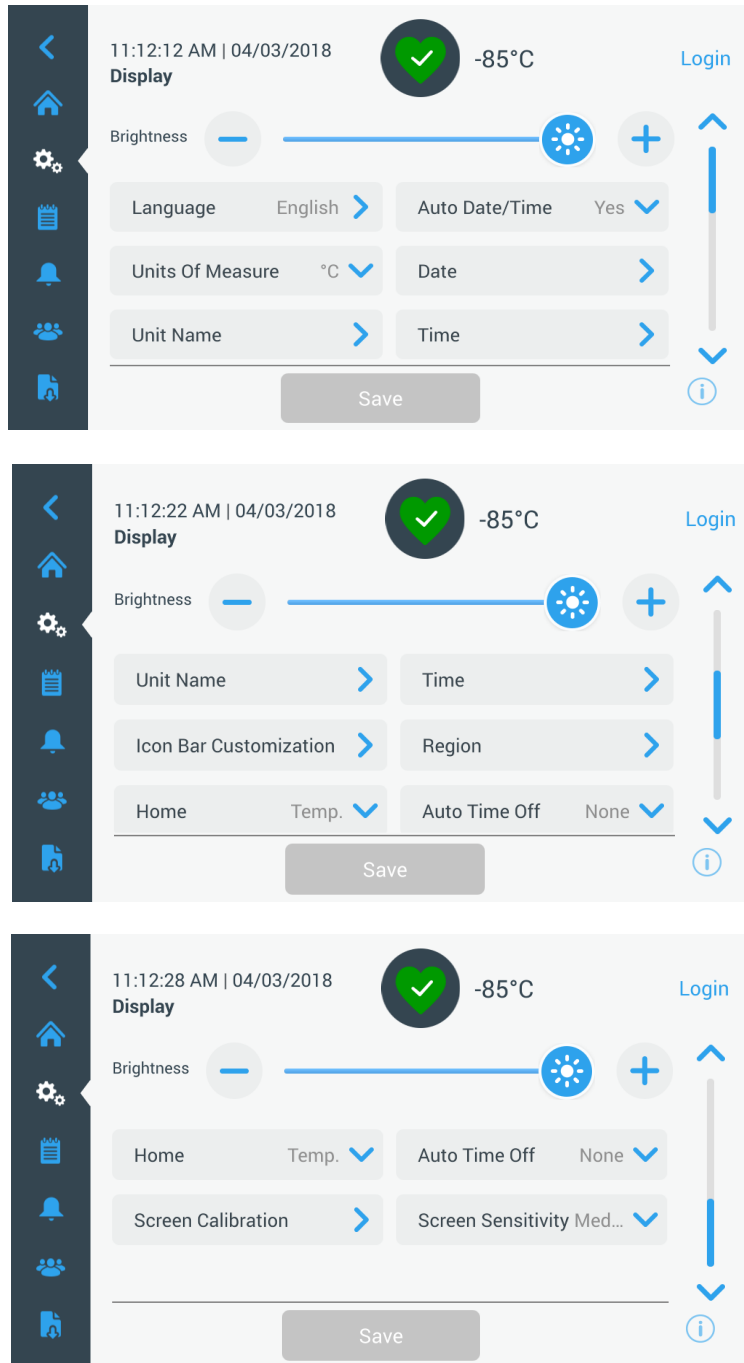

Figure 32. Display Screen

- **Brightness:** Use the slide control or the +/- buttons to adjust the brightness level of the display.

- **Language:** To change the display language, press the Language button and select the desired language.
- **Auto Date/Time:** To manually set the date and time, turn this setting off and select the format.
- **Units of Measure:** To change the displayed unit of measure, press the Units of Measure button.
- **Date:** To set the date and the date format, press the Date button.

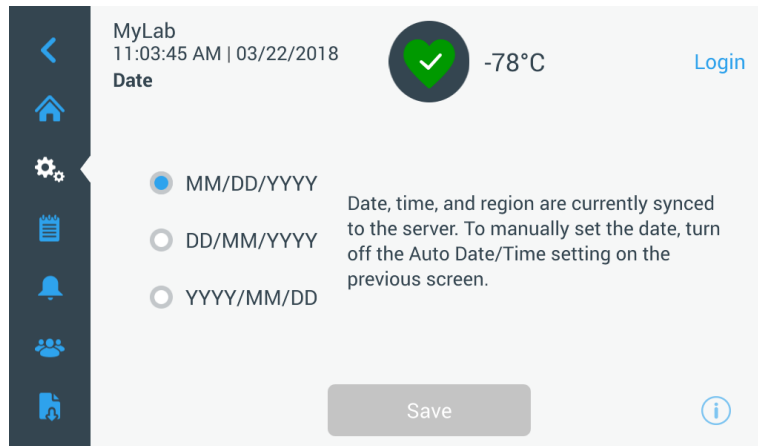

Figure 33. Date Screen

- **Unit Name:** To enter or change the unit name, press the Unit Name button.
- **Time:** To set the time and time format, press the Time button.
- **Icon Bar Customization:** This is used to customize the bottom three icons in the navigation bar.
- **Region:** This is used to set the region the unit is operating from.
- **Home:** To select the default home screen, press the Home button.
- **Auto Time Off:** Select the time range for when the LCD will automatically darken. The default option None, will leave the LCD constantly illuminated.
- **Screen Calibration:** Press to run a screen auto calibration routine.
- **Screen Sensitivity:** Select to modify the touch sensitivity of the screen.

Select the Save button after making the necessary changes.

9.3.3 Users Access Mode is used to change the access mode for the system (full or secured), add a user to the system, and to import and/or export a user database.

The Users screen can also be accessed by using the User Icon on the left navigation bar. For more information, refer to Section 9.6.

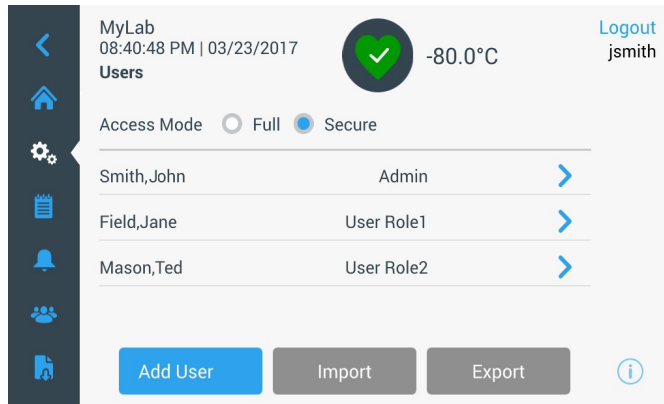

Figure 34. Users Screen

9.3.4 Files and Info The following screen is displayed when the Files and Info button is selected:

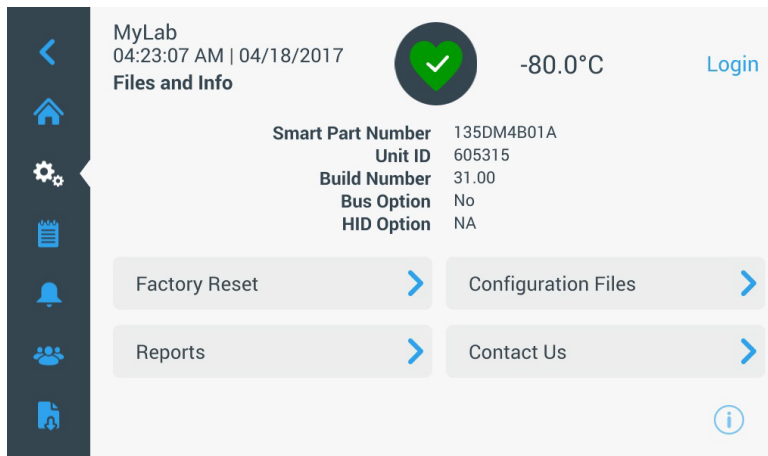

Figure 35. Files and Info Screen

- **Factory Reset:** Select to reset the settings, including temperature set point to factory defaults.
- **Configuration Files:** This is used to export or import configuration files. Configuration files may be uploaded to other freezers.
- **Reports:** This is used to export temperature and event data. A date range can be provided too. Refer to Section 9.7 for more information.

- **Contact Us:** Press this button to view or modify the service contact information.

9.3.5 Controls

Temperature set points can be set in the Controls screen. To select a temperature set point,

Select the Controls button to navigate to the Controls screen.

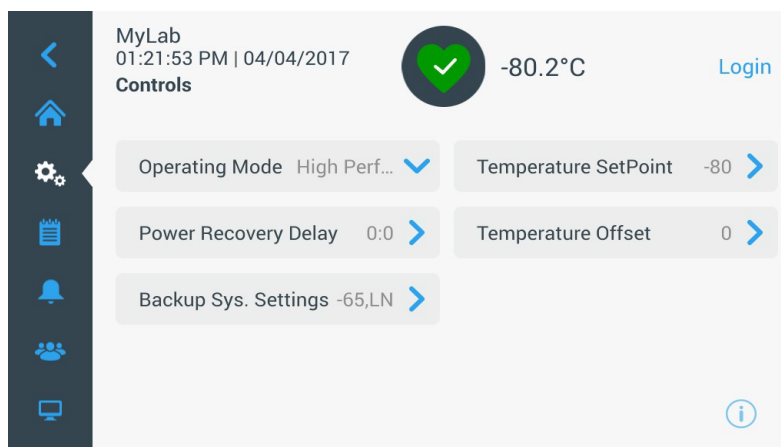

Figure 36. Controls Screen

- **Operating Mode:** The default setting is the Standard mode, which provides a balance between power consumption and peak variation performance. High Performance mode provides minimum temperature peak variation.

Note: Customers performing on-site temperature calibration may observe as much as a 2°C variation when an external probe is placed next to the freezer control probe. This variation is due to optimization of the control system to ensure temperature uniformity throughout the chamber.

- **Power Recovery Delay:** Press this button to set the time delay upon startup after power failure. Default is 0.
- **Temperature Offset:** This is used for calibration. Range is -10°C to +10°C. Default is 0.
- **Backup System Settings:** This screen allows the user to select the backup type and backup set point for units with a backup system installed. For more information, refer to Section 11.

- Press the Temperature Set point button to display the Set-points screen:

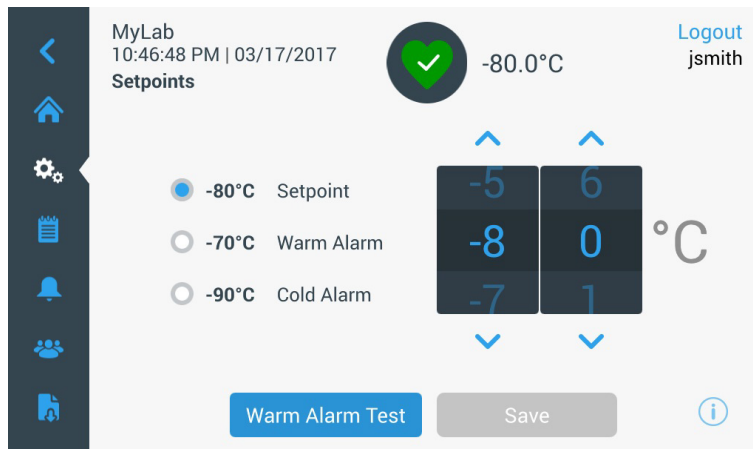

Figure 37. Setpoints Screen

- The set point and temperature alarm parameters may be adjusted by swiping the spin control up / down or pressing the up / down arrows.

Note: *A set point change may automatically change the warm and / or cold alarm set points as well to prevent unnecessary alarms.*

- After selecting the temperatures, press the Save button to confirm changes.

Note: *If the save button is not pressed, the unit will not respond to the set point change request.*

Warm Alarm Test: Pressing this button puts the system into a warm alarm test which simulates a warm alarm experience. Once this is selected, the home screen is displayed with the current temperature readout. The temperature display will increase to the warm alarm temperature set point. Once the warm alarm temperature has been reached, the user is prompted to end the test.

9.3.6 Connectivity

The Connectivity tab is used to setup a wireless network and connect to InstrumentConnect. Be sure to follow both steps to store information on InstrumentConnect.

The following screen is displayed when the Connectivity button is selected.

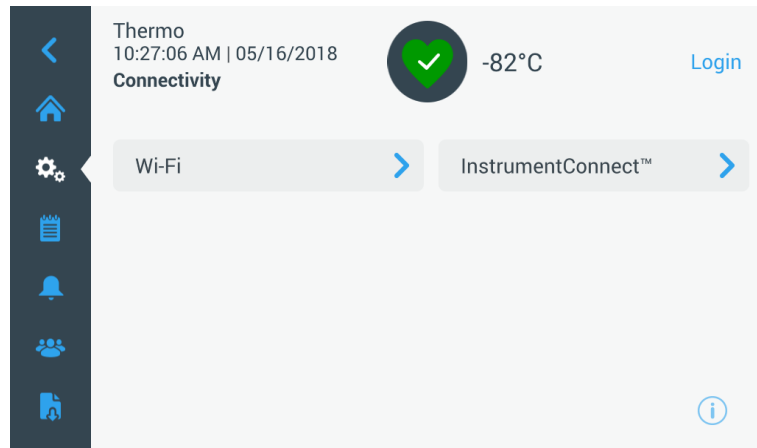

Figure 38. Connectivity Screen

9.3.6.1 Wi-Fi

Press the Wi-Fi button to connect to a network. Select the network from the list and press the Next button.

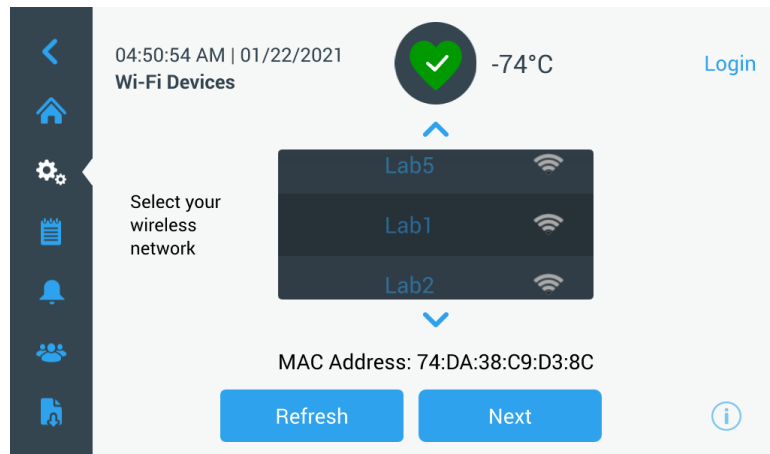

Figure 39. Wi-Fi Devices Screen

Enter the network password and press the Join button.

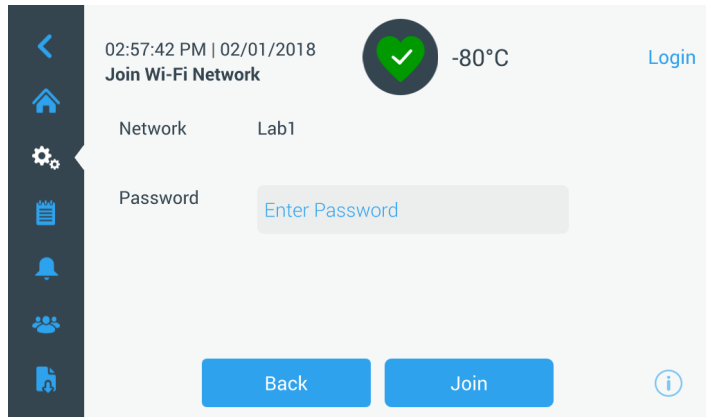

Figure 40. Join Wi-Fi Network Screen

Note: *The on-screen keyboard does not support all special characters. Please inquire with your local IT group for assistance with password reset to accommodate allowable character entry.*

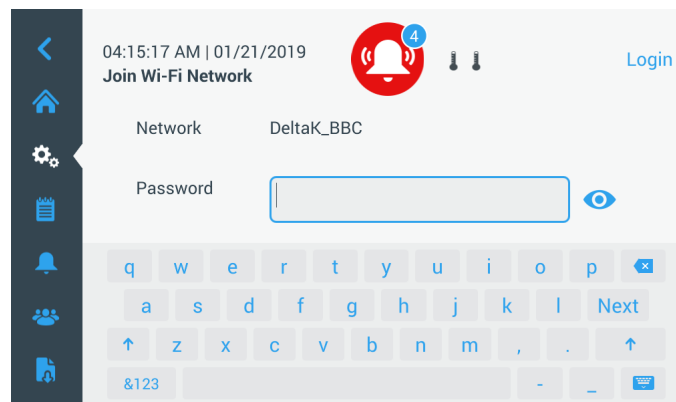

Figure 41. On Screen Key board

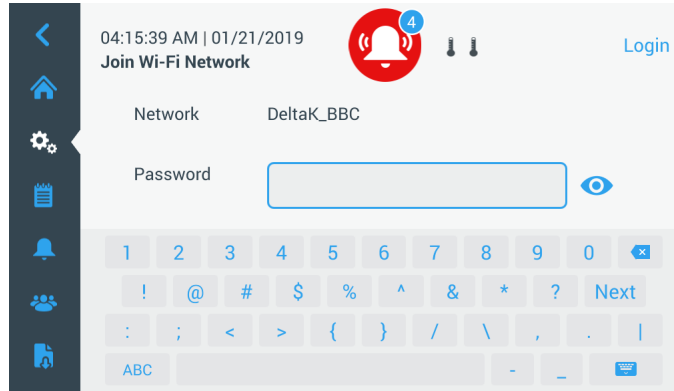

Figure 42. On Screen Key-board

A success message is displayed once the connection is established. If the connection fails, either due to an incorrect Wi-Fi password or network unavailability, a general error message is displayed. After 5 seconds, the interface will return to the previous screen.

If this occurs, check the network status and re-enter the correct password to establish the connection. (Tip: use the eye icon to verify the password entry before attempting connection.)

Refer to Section 15 for connectivity troubleshooting.

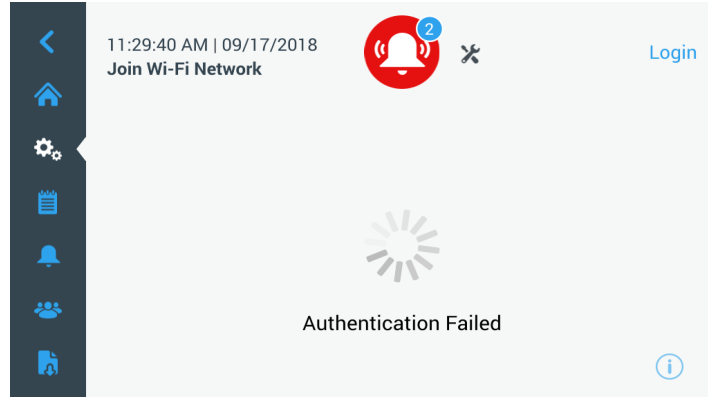

Figure 43. Wireless Setup Error Message Screen

9.3.6.2 Removing Wi-Fi Connection

To remove an established connection first select the network you wish to disconnect from within the selection screen shown in Figure 39 and press the Next button. On the following network information screen, press the Forget Network button. You will be prompted to confirm your selection. Once the connection has been disabled, the screen will return to the Wi-Fi Device selection screen pictured in Figure 39.

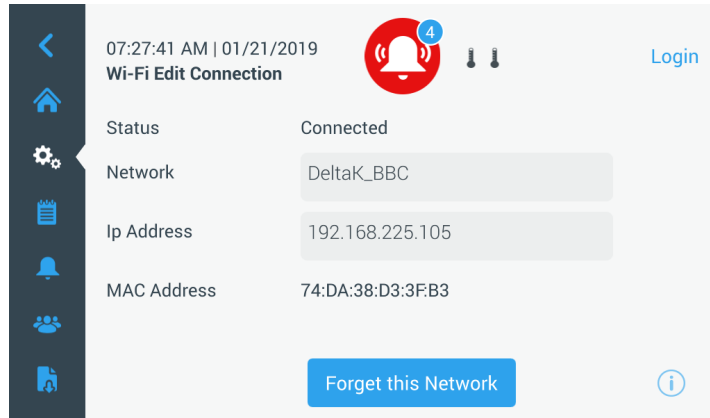

Figure 44. Wireless Setup Connection Message Screen

9.3.6.3 InstrumentConnect

The following screen is displayed when you select the InstrumentConnect button in Figure 38.

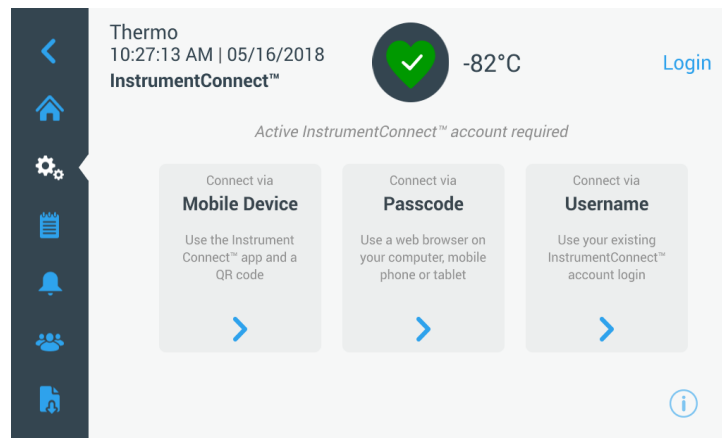

Figure 45. InstrumentConnect Screen

Connect via Mobile Device

Selecting the Connect via Mobile Device option displays a screen with instructions. Follow the instructions to connect to InstrumentConnect.

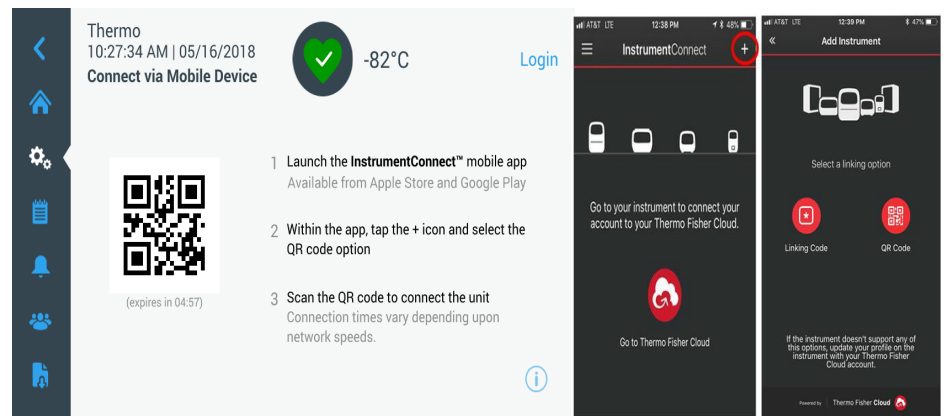

Figure 46. Connect via Mobile Device Screen and InstrumentConnect Mobile Interface Screens

Connect via Passcode

This option displays a code that has to be entered to connect to InstrumentConnect.

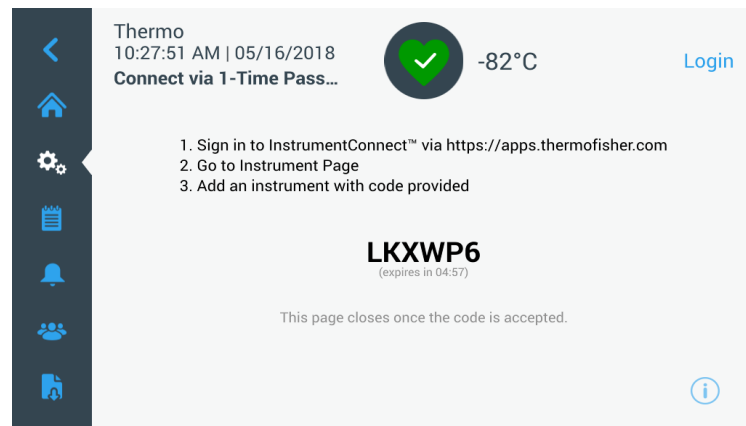

Figure 47. Connect via 1-Time Passcode Screen

Note: When using the InstrumentConnect web and mobile app, ensure you are in the correct regional environment. If you are in China, you should select the China region. Refer to Section 8.1 for more details.

Connect via user name

Sign in using your InstrumentConnect user name and password and press the Link Account button.

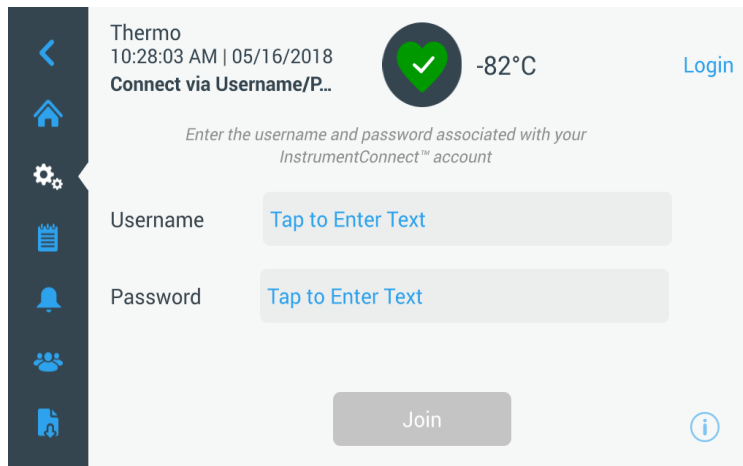

Figure 48. Connect via user name/Password Screen

If the connection is successful via any of the three methods, a success message is displayed.

If the connection is unsuccessful an error message is displayed. After 5 seconds, the interface will return to the previous screen. Check the network status and any entered passwords, etc. and repeat the previous steps to establish a successful unit connection.

Refer to Section 15 for more connectivity troubleshooting.

9.4 Event Log

The third tab on the navigation panel is the event log that contains a record of user and system events. The Event Log screen will be displayed once the Event Log icon is pressed.

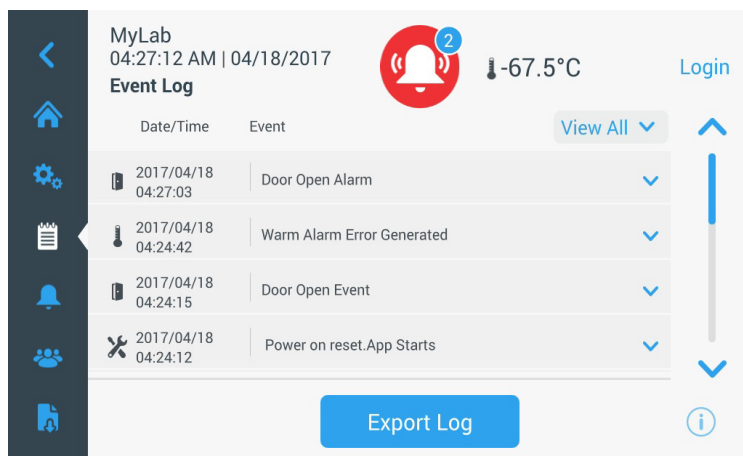

Figure 49. Event Log Screen

This screen displays up to two weeks of recent events, with date time stamps for each event.

The Date/Time and Event columns can be sorted in an ascending or descending order by selecting the column header.

Additional information of an individual event can be viewed by selecting the event.

There is a drop down list based on the event types. The event types can be filtered and categorized into: Alarm, Door, User, Battery and Backup. When a filter is selected, the View All button on the right changes to Filter ON.

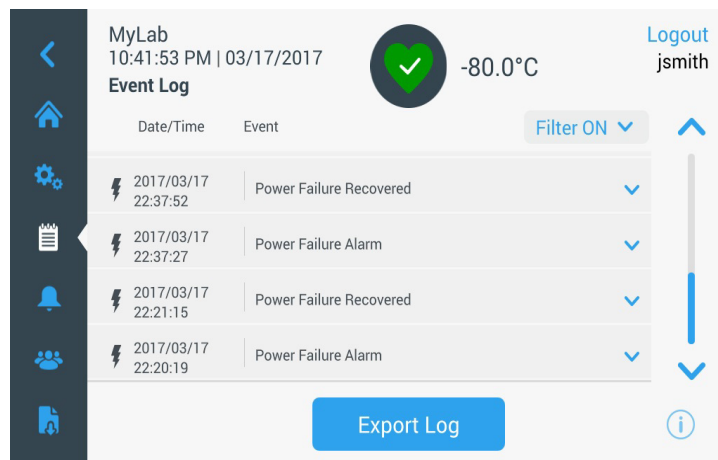

Figure 50. Event Log Screen with Filter

To export event and temperature logs,

1. Choose the item to be exported from Export drop down list. The options available are: Event and Temperature Log, Event Log, Temperature Log and Reports.
2. Select the export format of the log or report.
3. A predefined or custom date range may be selected.

4. A USB drive must be inserted to store the log or report. Press the Export Log button to download the log or report.

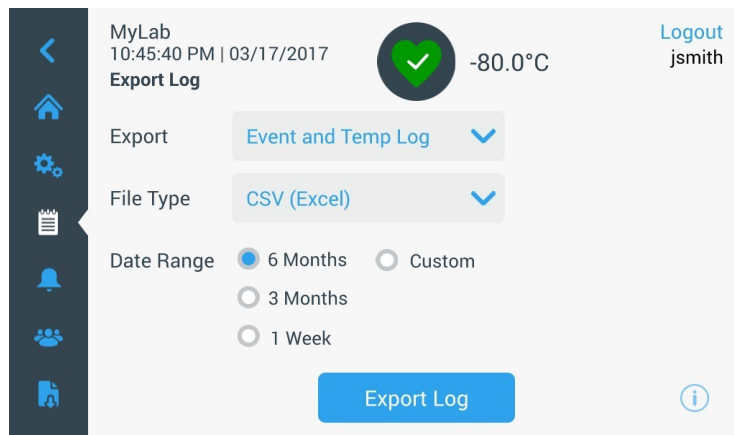

Figure 51. Export Log Screen

9.5 Alarms

By selecting the Alarm tab, the Alarm Settings screen is displayed. For more information on set points, refer to Section 9.3.1.

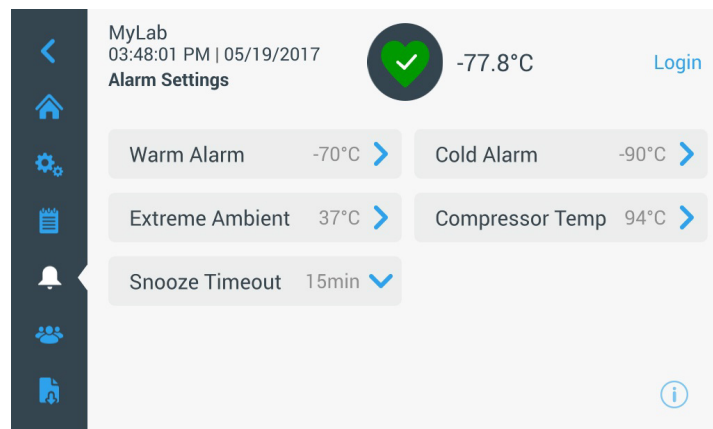

Figure 52. Alarm Settings Screen

9.6 Users

The User tab is used to display the Users screen. Access Mode is used to change the access mode for the system (full or secured), add a user to the system, and to import and/or export a user database. The following screen is displayed when the User icon is selected:

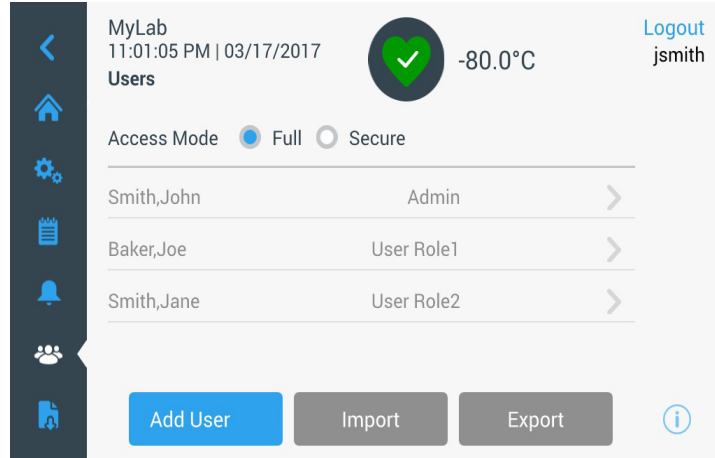

Figure 53. Users Screen

The Import button allows a user database to be imported.

Note: *The database to be imported must be taken from another unit running the same software otherwise the system will not recognize the database.*

The user database can be exported using the Export button. A USB drive must be inserted for the data to be transferred.

9.6.1 Adding New Users

Select the Add User button to navigate to the Add a User screen:

The figure shows two sequential screenshots of the 'Add a User' screen in the MyLab application. The top screenshot shows the initial form with the following fields: First Name*, Last Name*, Email*, and User Name*. The bottom screenshot shows the form after the 'Add User' button is pressed, with the following fields: Confirm Password, Phone: Office, User Role, and Access ID. The 'Add User' button is visible at the bottom of both screenshots.

Figure 54. Add a User Screen

Fill in the information in the fields and press Add User. An asterisk denotes a required field.

- **First Name:** Enter the user's first name.
- **Last Name:** Enter the user's last name.
- **Email:** Enter the user's email address.
- **User Name:** Enter the user name as required. A default will appear based upon the email address entered.
- **Password:** Enter and confirm a user password. The password entered should be 3-16 characters long, have at least 1 uppercase, 1 number and 1 special character.
- **Phone:** Enter a user telephone number. Additional phone numbers can be added by pressing the '+' symbol.

- **User Role:** Select the access level for the user.
 - Admin: This user has access to change settings and manage profiles.
 - User Level 1: This user has access to change basic functionality such as temperature and alarm set points.
 - User Level 2: This user can view the temperature and alarm information but cannot change the settings (Primarily used when unit is equipped with HID Access ID, as anyone needing access to the freezer must have a user role).
- **Access ID:** Refer to Section 9.6.3 for more information on access cards.

9.6.2 Editing and Deleting Users

To edit an existing user, press the user entry in the Users screen and User Details screens will be displayed. Make the required edits by selecting the appropriate field and changing the information. After making the changes, press the “Edit User” button and confirm.

To delete a user, select the Delete User button and confirm.

Note: *This action cannot be undone.*

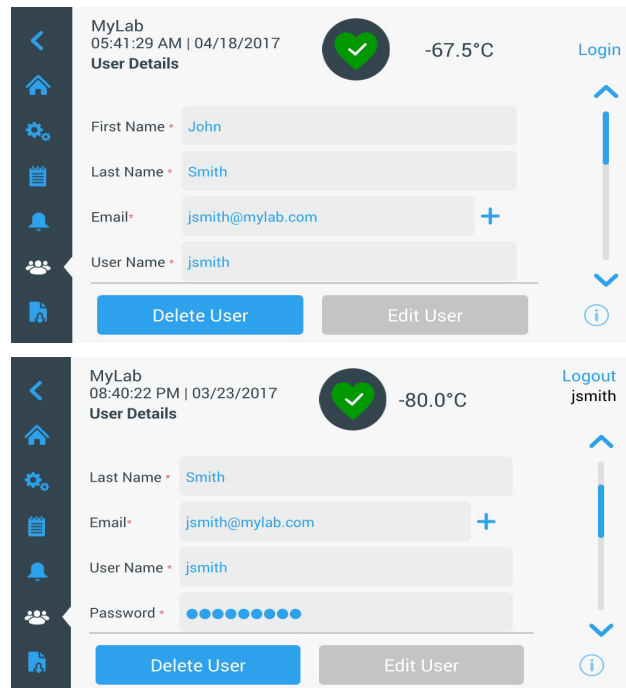

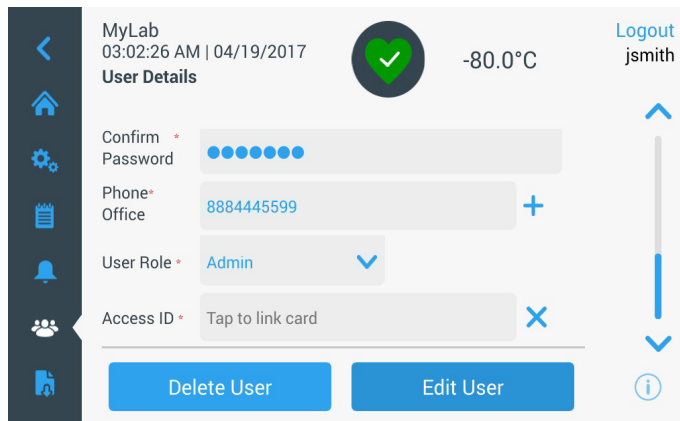

Figure 55. User Details Screen

9.6.3 Managing Access Cards

When the Access Card system is installed, the User Details screen allows assigning cards to each user. Users may then swipe their access card to gain access to the freezer or login.

To associate an access card to a selected user, press the Access ID field of the User Details screen (refer to Figure 55) and hold the card at the bottom center of the LCD screen. The Access ID field will automatically be populated and you will hear a beep. Only one card may be added per user. The Access ID must be unique for each user.

9.7 Reports

The Report tab is used to export a log or report. The Export Logs and Reports screen will be displayed when the Report icon is pressed. If Reports is selected as the Export type, the date range is limited to two options - one week (default) and one day. Refer to Section 9.4 for more information.

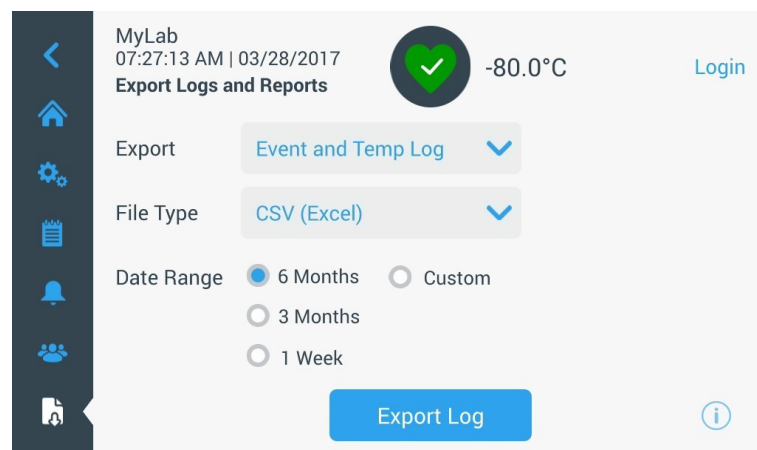

Figure 56. Export Logs and Reports Screen

9.8 Chart The chart displays temperature data.

There can be a maximum of two Y-axis. The left Y-axis is Primary and the right Y-axis is Secondary. Items displayed on the Primary axis are listed on the left and the ones displayed on the Secondary axis are listed on the right. Time is denoted on the X-axis.

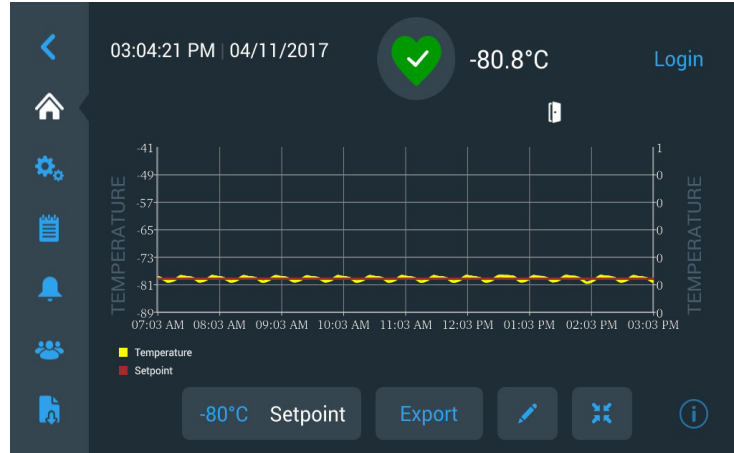

Figure 57. Chart with items on Primary axis

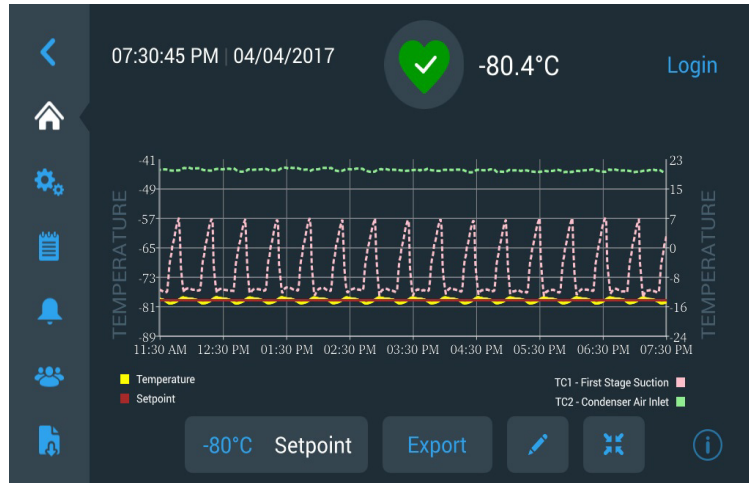

Figure 58. Chart with items on Primary and Secondary axes

The four buttons on the bottom of the screen are used to:

- Change the set point
- Export the chart
- Edit the chart, refer to Section 9.8.1 for more information
- Expand the chart to full screen or return to the default view.

9.8.1 Editing the Chart

When the Pencil icon is selected, the Chart Edit screen is displayed:

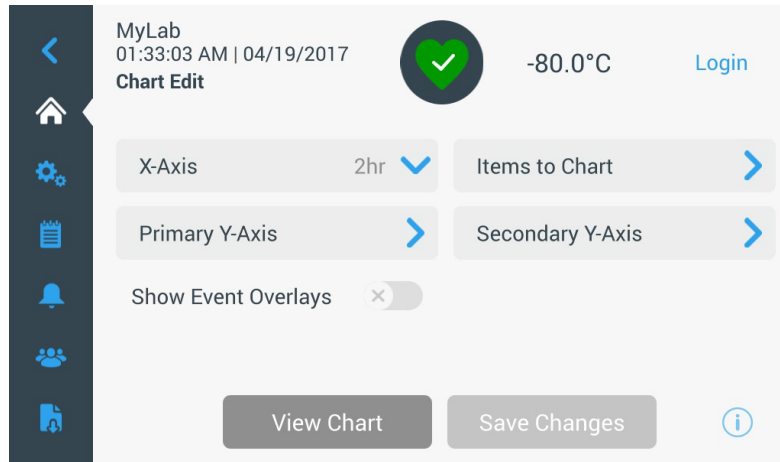
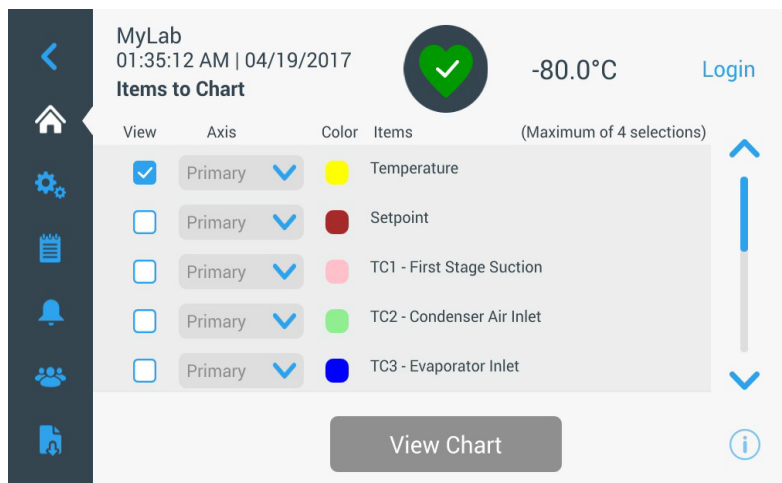

Figure 59. Chart Edit Screen

- The X-Axis button allows the user to select a time span of 2, 4, 6 or 8 hours.
- The Items to Chart button allows the user to select the items to be displayed on the chart. A maximum of four items may be selected.
- **Show Event Overlay:** Enable quick reference event icons to be displayed on the top of the chart.



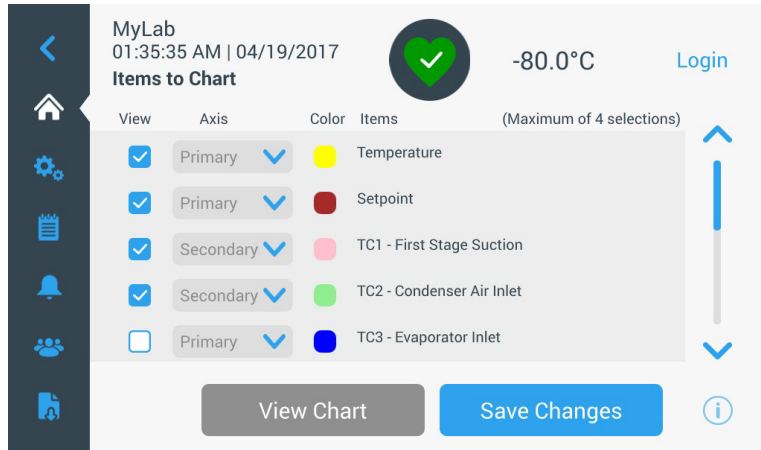

Figure 60. Items to Chart Screen

- The Primary Y-Axis button allows the user to set the temperature range. If Auto is selected, the temperatures are automatically set. If Manual is selected, the user has to specify the high and low temperatures.

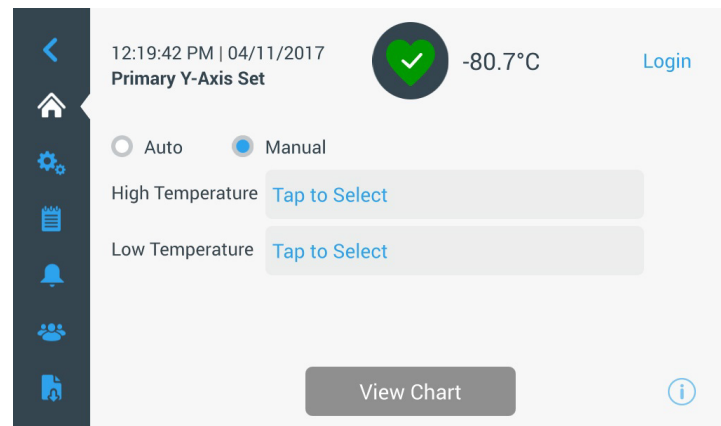
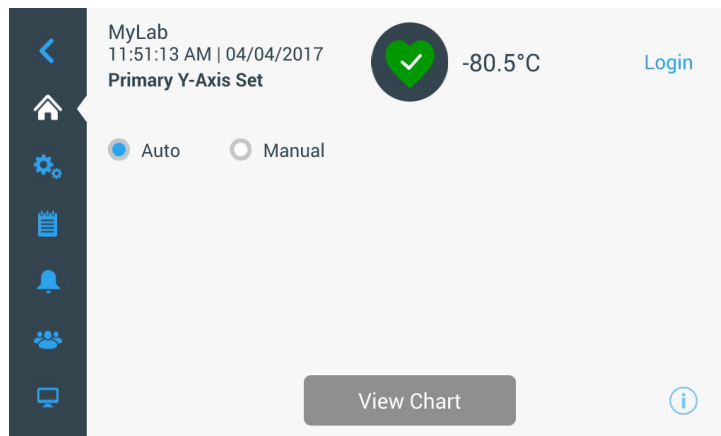

Figure 61. Primary Y-Axis Set screen

- The Secondary Y-Axis button allows the user to set the temperature range. If Auto is selected, the temperatures are automatically set. If Manual is selected, the user has to specify the high and low temperatures. Item associated with the Secondary Y-Axis will be displayed as a dotted line. The Axis On toggle button is used to enable the Secondary Y-axis.

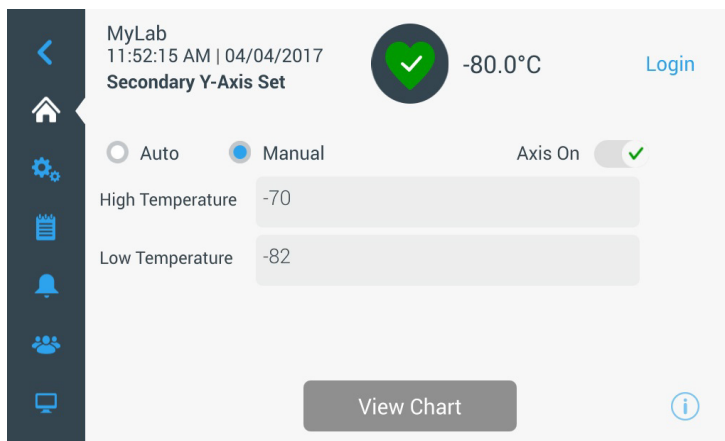









Figure 62. Secondary Y-Axis Set Screen

9.8.2 Event Icons Icons related to events will appear on the top of the chart.

Icon	Description
	Door Open
	Power Failure
	Temperature Alarm
	Service
	Multiple Events
	Connected to InstrumentConnect™
	Connected to Wi-Fi

10 Health Status and Alarm Management

10.1 Health Status Overview

Selecting the Health Status (green heart) icon in the home screen displays the following screen:

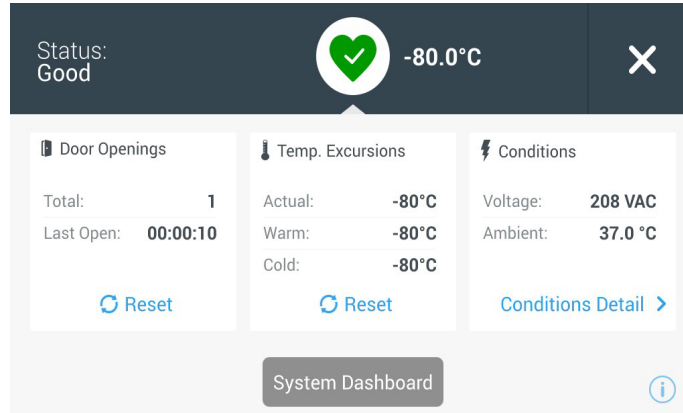

Figure 63. Health Status Screen

- **Door Openings:** Total displays the number of times the door has been opened since the last reset. Last Open displays the duration the door was last opened. Press the Reset icon to change the Door Openings values to 0.
- **Temperature Excursions:** Actual displays the current cabinet temperature. Warm and Cold displays are the highest and lowest temperatures recorded since the last reset. Press the Reset icon to set the Warm and Cold values to the current cabinet temperature.
- **Conditions:** Voltage displays the input voltage. Ambient displays the unit ambient temperature. By pressing the Conditions Detail button the following screen will be displayed:

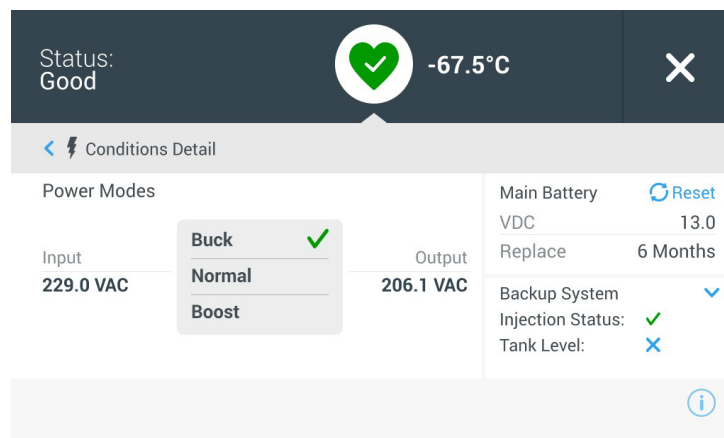

Figure 64. Conditions Detail Screen

- **Power Modes:** Displays the state of the on-board voltage conditioning system.
- **Main Battery:** Displays the voltage of the main battery. There is also a 12 month countdown timer that should be reset every time the battery is replaced.
- **Backup System (BUS):** The BUS information will be displayed if a BUS is present.

Selecting the System Dashboard button in Figure 63 displays the on board sensor readings.

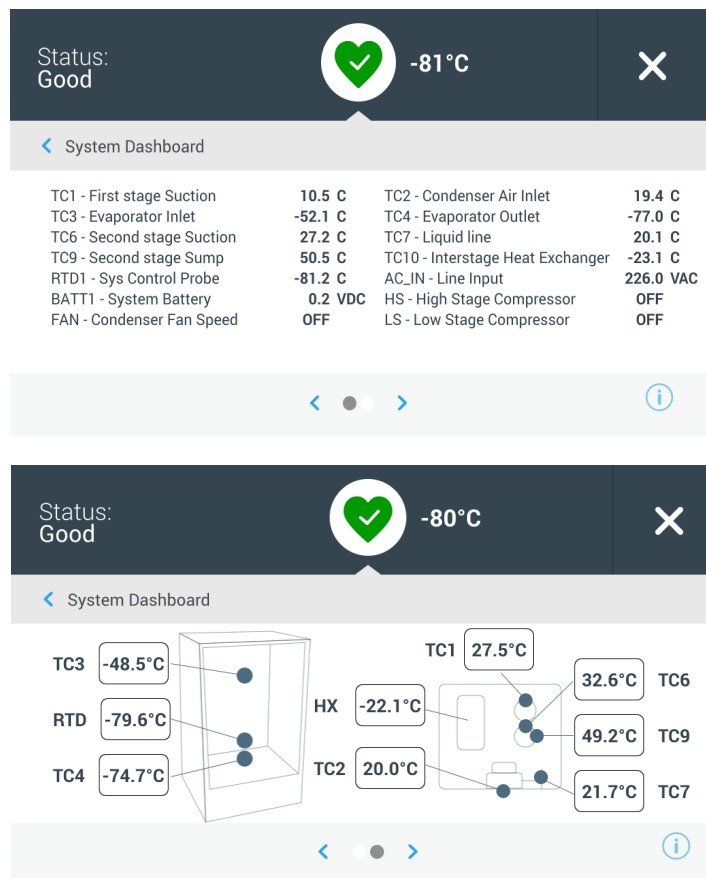

Figure 65. System Dashboard Screen

When a BUS is present, the BUS RTD and BUS battery values are also displayed.

10.2 Notifications / Cautions

In the event of a notification, the green heart is replaced by a yellow triangle icon. The number in the blue circle indicates the total number of notifications.

A yellow triangle on the home screen indicates less serious caution conditions, such as extended door openings and alarms that occurred in the past.

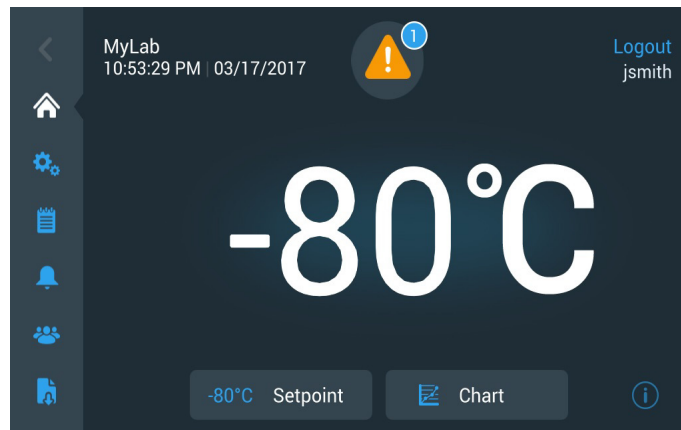

Figure 66. Home Screen with Notification / Caution

Press the yellow triangle to display additional notification details.

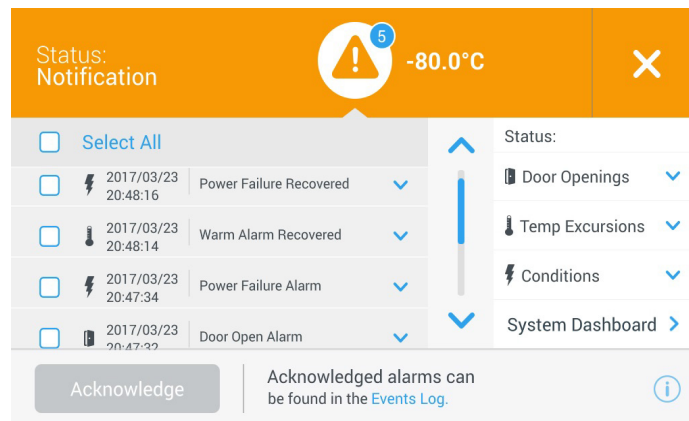

Figure 67. Notification / Caution Details

The Acknowledge button becomes highlighted in blue once a notification is selected by pressing the adjacent check box. The notification will be displayed until it is acknowledged. There is a link to the Event Log beside the Acknowledge button.

On the right panel, the Health Status details can also be viewed.

10.3 Alarms / Warning

In the event of an alarm condition, the green heart or yellow triangle is replaced by a red bell icon. A red bell alarm on the home screen indicates a serious alarm condition which must be corrected, such as a warm alarm or a power failure. The alarm can be silenced by pressing the Snooze button or the Red Bell icon which will mute the alarm for a duration set in the Snooze Timeout setting.

The number in the blue circle indicates the total number of alarms. The icon to the right of the bell helps identify the alarm type. The ticker message provides alarm details.

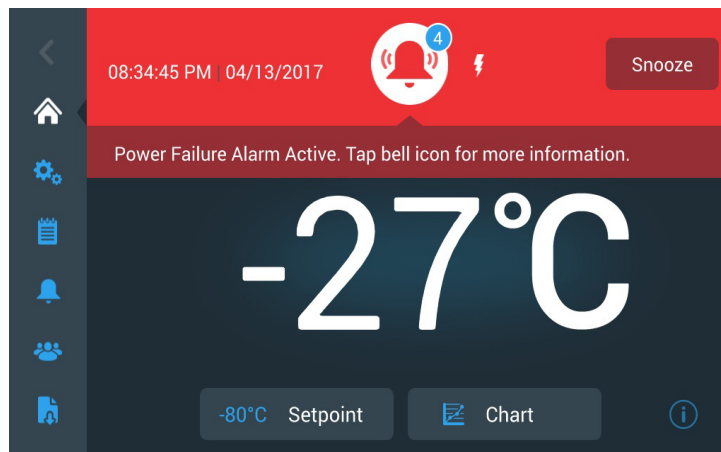

Figure 68. Home Screen with Alarm / Warning

Press the red bell for additional information about the alarms.

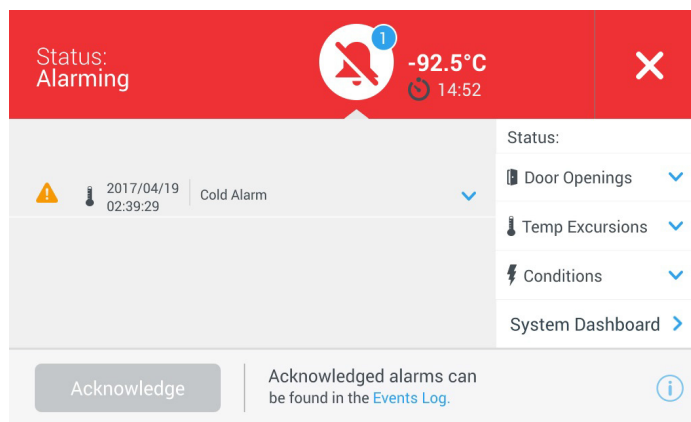

Figure 69. Alarm / Warning Detail Screen

If an alarm and a notification occur at the same time, the alarm red bell icon is displayed and the list includes both alarms and notifications.

The Acknowledge button becomes highlighted in blue once an alarm is selected by pressing the adjacent check box. Active alarms cannot be cleared until the issue is addressed. There is a link to the Event Log beside the Acknowledge button.

On the right panel, the Health Status details can also be viewed.

For more information on various alarm conditions, refer to Appendix A: Alarm Summary.

11 Backup System (Optional)

When you purchase a built-in CO₂ or LN₂ optional backup system for the freezer, backup control is integrated into the main user interface.



Note: Always purchase the cylinders which are equipped with siphon tubes for withdrawing liquid from the bottom of the cylinder. CO₂ cylinders must be kept at room temperature to function properly. LN₂ bottles are functional at any reasonable temperature.

11.1 CO₂ and LN₂ Precautions

The following are precautions for using liquid CO₂ and LN₂ backup systems.



WARNING: If a CO₂ or LN₂ cylinder falls and a valve is knocked off, the cylinder becomes a deadly and completely unguided missile. Transport the cylinders in a hand-truck or cart with secure chain ties for the cylinder. After cylinders are connected to the equipment, securely attach them with chains to a solid, stationary object such as a building column.



WARNING: CO₂ and LN₂ liquids are non-poisonous but are very cold and will burn unprotected skin. Always wear protective eye wear and clothing when changing cylinders or working on the piping systems attached to an active source of liquid refrigerant.



WARNING: The gases produced by evaporation of CO₂ or LN₂ are non-poisonous but displace the oxygen in a confined space and can cause asphyxiation. Do not store the cylinders in subsurface or enclosed areas.



CAUTION: When closing the cylinder valve, make sure that the injection solenoid is energized to allow all the liquid to bleed off instead of being trapped in the supply hose. Failure to do this results in activation of the pressure relief device, which could damage the freezer and requires replacing if it is activated.



CAUTION: For models ordered with factory installed built-in backup systems, the flow of liquid CO₂ or LN₂ will be discontinued if the door is opened during operation of the backup system. For units operated with free-standing, field installed type backup system, the flow of liquid CO₂ or LN₂ will be discontinued upon door opening only if the switch provided with the free-standing package is installed on the freezer.

11.2 Installation

Field installed systems are supplied with complete installation and operating instructions. If your system is factory installed, the freezer is shipped with a coiled length of hose to connect the freezer to the bottles:

- 1/4" Flexible Hose with fittings for connection to the CO₂ supply.
- 1/2" Flexible Hose with fittings for connection to the LN₂ supply.

To install,

1. Straighten the coiled hose.
2. Connect one end to the labeled connection on the freezer.
 - Tighten the nut two flats past finger tight, approximately 120 degrees.

Note: For CO₂, remove the threaded fitting from the nut on the end of the copper tubing to access nut for connection to the freezer. Discard the threaded fitting.

3. Attach the other end to the supply bottle or building supply fitting.
 - For CO₂:
 - Remove Nipple from adapter (NPT Connection). Remove cable tie to release alternative nut and washer. Ensure the correct nut fitting is supplied over the nipple (US or European).
 - Add 2 wraps of Teflon tape clockwise to the 1/4" NPT fitting (on the nipple) when viewed from the threads. Tighten the NPT fittings approximately 2 turns from finger tight (approximately 720°).

Note: The top of the nipple has a hex configuration, allowing for use of a wrench when the nut is pulled down.

- Add washer to nipple inside of nut (unless CO₂ supply has a built in washer).

Note: Small raised area of washer fits into groove of nipple. The washer will feel snug when trying to shift side to side on nipple. The washers are designed for a limited number of attachments/disconnections from the supply and may wear over time. If washer appears worn and causes CO₂ leakage, replace washer (Part Number 45705H03).

- Wrench tighten the supply nut to the supply.
- For LN₂:
 - Attach the fitting to the supply and wrench tighten.



Note: Do not twist, torque, or subject the flexible hose to sharp bends. Doing so may shorten the life of the hose.

11.3 Start Up

To activate the backup system:

1. Follow the instructions in Section 8 to turn on the freezer and set temperature and alarm set points.
2. Select the backup type and backup set point on the Backup Setting Screen below, which can be accessed through the Controls option in the Settings tab (refer to Figure 36).

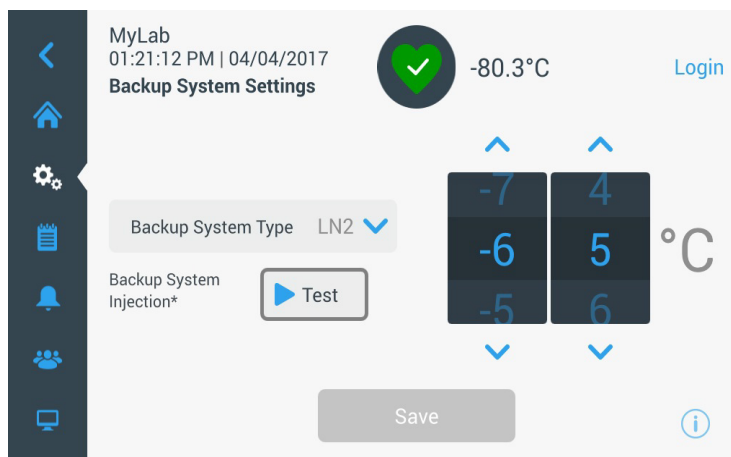

Figure 70. Backup System Settings Screen

3. Press the Save button to save the changes made.

11.4 Operation

When the backup system is in operation, the parameters can be viewed and configured on the settings screen.

Once the backup system has been activated, it can be tested by pressing the Test button. The system will inject as long as the button is being pressed.

The backup system can run for a minimum of 24 hours on battery power.

On average, a backup system in operation uses 8 to 10 lbs. per hour of CO₂ (3.6 to 4.5 L/hr) or LN₂ (4.5 to 5.6 L/hr) at an ambient temperature of 25°C.

12 Chart Recorders (Optional)

Panel-mounted six-inch seven-day recorders are available as options for all freezer models except for the smallest (300 box capacity) models.

12.1 Set Up and Operation

To prepare the recorder to function properly, complete the following steps:

1. Open the grille door to access the recorder.
2. Install clean chart paper (refer to Section 12.2).
3. Remove the plastic cap from the pen stylus or ink pen and close the recorder door.

Recorder operation begins when the system is powered on. The recorder may not respond until the system reaches temperatures within the recorder's range.

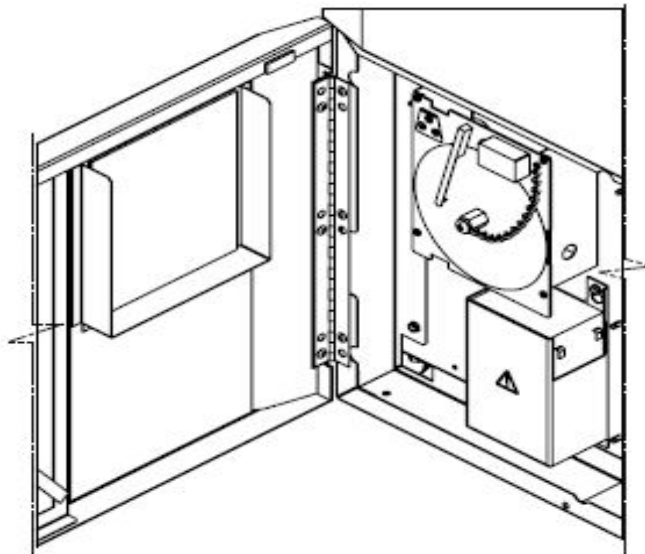

Figure 71. Chart Recorder

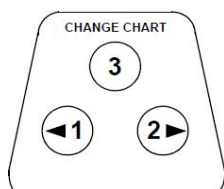

Figure 72. Chart Buttons



CAUTION: Do not use sharp or pointed objects to depress the chart buttons. This may cause permanent damage to the recorder.

12.2 Changing Chart Paper

To change the chart paper, complete the following steps:

1. Locate the pressure sensitive buttons at the front, upper left of the recorder panel.
2. Press and hold the Change Chart button (#3) for one second. The pen will move off the scale.
3. Unscrew the center nut, remove the old chart paper, and install new chart paper. Carefully align the day and time with the reference mark (a small groove on the left side of the recorder panel).
4. Replace the center nut and hand tighten. Press the Change Chart button again to resume temperature recording.

12.3 Calibration Adjustment

This recorder has been accurately calibrated at the factory and retains calibration even during power interruptions. If required, however, adjustments can be made as follows:

1. Run the unit continuously at the control set point temperature. Continue steady operation for at least two hours to provide adequate time for recorder response.
2. Measure cabinet center temperature with a calibrated temperature monitor.
3. Compare the recorder temperature to the measured cabinet temperature. If necessary, adjust recorder by pressing the left (#1) and right (#2) chart buttons.

Note: *The stylus does not begin to move until the top center button (#3) is held for five seconds.*

13 Maintenance



WARNING: Unauthorized repair of your freezer will invalidate your warranty. Contact Technical Service at 1-800-438-4851 for additional information.



CAUTION: Maintenance should only be performed by trained personnel.

13.1 Cleaning the Condenser

Clean the condenser at least every six months; more often if the laboratory area is dusty.

To clean the condenser, complete the following steps:

1. Pull the grille door open.
2. Vacuum the condenser.
3. Inspect the filter cleanliness and clean as required.
4. Close the grille door.

13.2 Cleaning the Condenser Filter

Clean the condenser filters every two or three months.

There are two condenser filters: a main filter and a lower filter for extra air flow into the condenser.

1. Pull the grille door open.
2. Remove the filters.
3. Shake the filters to remove loose dust, rinse the filters in clean water, shake the excess water from the filters, and replace the filters.
4. Close the grille door.

13.3 Gasket Maintenance

Periodically check the gaskets around the door for punctures or tears. Leaks are indicated by a streak of frost which forms at the point of gasket failure. Make sure that the cabinet is level (refer to Section 7.3 for leveling information).

Keep the door gaskets clean and frost free by wiping gently with a soft cloth.

13.4 Defrosting the Freezer

Defrost the freezer once per year or whenever the ice buildup exceeds 3/8". To defrost, complete the following steps:

1. Remove all products and place in another ULT cabinet.
2. Turn off the freezer.
3. Open the outer door and all inner doors.
4. Let the freezer stand with doors open for at least 24 hours. This allows both the interior and foamed refrigerant system to warm to room temperature.
5. Dispose of the ice and wipe out any water standing in the bottom of the cabinet.
6. If there is freezer odor, wash the interior with a solution of baking soda and warm water.
7. Clean the exterior with any common household cleaner.
8. Close the doors, restart the freezer and reload. Refer to Section 5.3 to follow the instructions.

13.5 Battery Maintenance

The freezer monitors the voltage status of the battery daily and indicates the battery's voltage via visual and auditory alarm. Replace the battery as indicated by system alarms or as necessary per individual status evaluation. Check the battery connections regularly. Although not required, annual battery replacement is recommended to ensure proper battery status in the event of power failure. Be sure to reset the battery replacement timer via the user interface whenever the battery is replaced.

For safety, it is recommended to power off the unit and disconnect it from the power source before replacing the battery. Battery terminals are color coded red and black. Ensure the corresponding colored wires are connected to the matching color terminals on the battery. The battery is installed with terminals oriented toward the condenser compartment or hinge side of the freezer's outer door (refer to Figure 73) With proper installation, the red wire should be connected to the rear battery (positive) terminal and the black wire to the front (common) terminal.

Failure to properly connect the battery can damage electrical components and potentially hinder normal operation of the freezer. Consult a certified service technician if there are any questions or concerns about battery maintenance.

Battery Specification:

Rechargeable sealed lead-acid battery, 12 V, 7.0 Amp Hr.
 Replacement batteries can be purchased directly from Thermo Fisher Scientific.

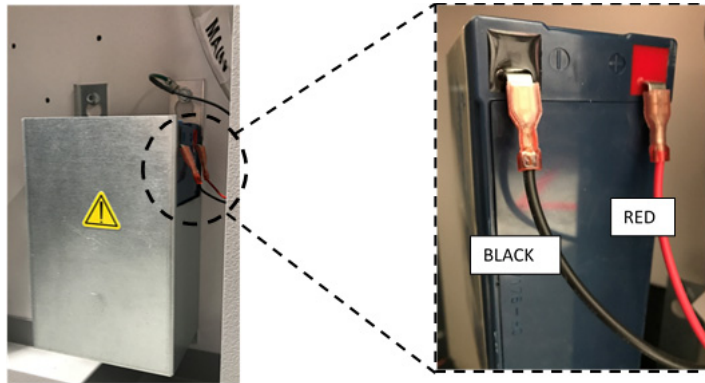

Figure 73. Battery Specification



13.6 Maintenance Schedule

Regular maintenance is important to keep the unit working properly. Inspect/Clean as directed in the manual.

Item	Interval
Defrost	Defrost the freezer once per year or whenever the ice build exceeds 3/8" (0.95 cm).
Gasket	Periodically check the gaskets around the door for punctures or tears. Periodically clean the ice-build up around the gasket.
Filter	Clean the condenser filter(s) every two to three months.
Condenser	Clean every six months, more often if the laboratory area is dusty.
Battery	Replace the battery as indicated by system alarms or as necessary per individual status evaluation. Check the battery connections regularly. Although not required, annual battery replacement is recommended to ensure proper battery status in the event of power failure.

14 Troubleshooting Guide

This section is a guide to troubleshooting general operational problems.

Problem	Cause	Solution
<ul style="list-style-type: none"> Unit warming. Unit set to -80°C but can't make temperature (Not reaching set point). Unit recovers slowly to set point. 	Warm load / Over load.	Allow ample time to recover from loading warm product. Do not overload cabinet. Please refer to Section 5.3 in user manual for loading procedures.
	Hot environment.	Check, if the location meets ambient requirements (within 15°C to 32°C or 59°F to 90°F) and away from hot objects.
	Dirty condenser and condenser filter.	Clean condenser and filter. Please refer to Section 13.1 and Section 13.2 in user manual.
	Not enough space for air circulation.	Install the unit in a level area free from vibration with a minimum of 8 inch (20 cm) of space on the top and sides, 6 inch (15 cm) in back.
	Icing/Frost due to high relative humidity.	Check if the location meets requirements. Maximum relative humidity 60% for temperatures within 15°C to 32°C (59°F to 90°F).
	Excess frost build-up in chamber.	Defrost the unit. Please refer to Section 13.4 in user manual.
	Frost build-up on outer door gasket.	Occasionally scrape the ice on the gasket.
	Gasket damage.	Check for punctures or tears on gasket. Replace if necessary. Please refer to Section 13.3 in user manual.
	Prolonged door openings.	Avoid opening of door for longer duration. Allow ample time for recovery after door opening.
	Inadequate power supply.	Check for proper voltage to the unit.
	Either of the compressors are not working.	Call service.
Refrigerant is not sufficient.	Call service.	
<ul style="list-style-type: none"> User interface (Display) failure. 	Breaker switch off.	Check circuit breaker and reset to on position. Always use a dedicated, properly grounded circuit.
	User interface not powered on.	Push power button  on user interface and hold for at least 1 second .
<ul style="list-style-type: none"> Unit is ON but display is showing empty. 	User interface not powered on.	Push power button  on user interface and hold for at least 1 second . Try touching the screen. Try restarting the unit manually by flipping the breaker at the rear of the unit. If this doesn't work, call service.

Problem	Cause	Solution
<ul style="list-style-type: none"> • Display is looking dull. 	Screen brightness is too low.	From the settings screen, pressing the display button will show the display. Adjust the brightness level of the display (Refer Section 9.3.2 in user manual).
<ul style="list-style-type: none"> • Power failure to the unit. 	Power supply stopped /Breaker switch off.	Confirm that the cord is securely plugged in.
		Plug another appliance into the outlet to see if power is present.
		Reset circuit breaker to on position and push power button  on user interface and hold for at least 1 second .
		Always use a dedicated, properly grounded circuit.
<ul style="list-style-type: none"> • Unit tripping the circuit breaker. 	Shared power source.	Never connect unit to overloaded power source. Always use a dedicated (separate) circuit.
	Unit plugged into wrong power outlet.	Plug the unit into proper power source to deliver correct voltage.
	Unit not grounded.	Your unit must be properly grounded in conformity with national and local electrical codes. Troubleshooting procedures involving live voltage is dangerous and if done improperly can result in injury and/or death. This troubleshooting should be performed by trained personnel only.
	Use of extended cords.	Do not use an extension cord. Make sure the unit supplied power cord is plugged directly into power outlet.
<ul style="list-style-type: none"> • Excessive frost build-up around perimeter of door. 	Icing/Frost due to high relative humidity.	Check if the location meets requirements. Maximum relative humidity 60% for temperatures within 15°C to 32°C (59°F to 90°F). Occasionally scrape the ice on the outer door.
	Excessive and prolonged door openings.	Avoid opening door for a prolonged time.
	Gasket damage.	Check for punctures or tears on gasket. Replace if necessary. Please refer to Section 13.3 in user manual.
<ul style="list-style-type: none"> • Unit is over cooling. 	Set points may have changed.	Adjust the set point to run at desired set point under settings. Refer to Section 9.3.5 in user manual.
	Temperature offset may have changed.	Try adjusting the offset. Temperature offset can be set in the Controls screen under settings. (Please refer to Section 9.3.5 in user manual).
	Unknown.	Try re-starting the unit. If this doesn't help call service.

Problem	Cause	Solution
<ul style="list-style-type: none"> Unit compressors run continuously. 	Freezer set point is low.	Check whether the setpoint is in operating range. Change the setpoint if necessary.
	Frost build up.	Defrost the unit. Please refer to Section 13.4 in user manual.
	Dirty condenser.	Clean the condenser and condenser filter.
	Gasket damage.	Check for punctures or tears on gasket. Replace if necessary. Please refer to Section 13.3 in user manual.
<ul style="list-style-type: none"> Cabinet temperature reached an alarm condition, but suitable alarm is not activated. 	Alarm setpoints may be changed.	Check the present setpoints for temperature alarm conditions. Change the set points if required. Please refer to Section 9.3.1 in user manual.
<ul style="list-style-type: none"> Problem with temperature validation/calibration. 	Cabinet temperature displayed doesn't match with actual temperature.	Customers performing on-site temperature calibration may observe as much as a 2°C variation when an external probe is placed next to the freezer control probe. This variation is normal, due to optimisation of control system to ensure temperature uniformity throughout the cabinet.
<ul style="list-style-type: none"> Unit is experiencing too much cabinet temperature fluctuation (high uniformity/peak variation). 	Operating mode selected.	Change power mode to high-performance mode to have tighter peak variation. Refer to Section 9.3.5 in manual.
<ul style="list-style-type: none"> Unit is constantly alarming. 	Exterior door is closed but not sealed completely.	Clean any ice build-up on gasket and/or cabinet surface. Check for punctures or tears on gasket. Replace if necessary, please refer to Section 13.3 in user manual.
	Alarm icons appear on user interface home screen.	By pressing red bell or yellow triangle, the ticker message provides alarm details and recovery details. Please refer to Section 10.3 in user manual.
	Door open alarm, exterior door not closing completely.	Open door completely and immediately close and latch it.
	Door open alarm, exterior door is closed but not sealed completely.	Defrost exterior door gasket and make sure the door is completely sealed.
	Alarm set points may have changed.	Change the set points as required. Please refer to Section 9.3.1 in user manual.
<ul style="list-style-type: none"> Unit cycle on-percentage is increasing (Compressors are running more often than before). 	Ambient conditions.	Unit performance is directly impacted by these causes mentioned. Try maintaining ambient conditions, reducing load, reducing door openings.
	Warm load (or) over load.	
	Frequent and prolonged door openings.	Once temperature is stable, cycle dynamics should return to normal range. If not call service.

Problem	Cause	Solution
<ul style="list-style-type: none"> • Difficult to close / open the outer door. • Outer door alignment issues. 	Unit is not level.	Make sure the unit is level. Please refer to Section 7.3 in the user manual for levelling procedure.
	Frost accumulated on outer door gasket.	Scrape the ice occasionally on outer gasket.
	Door latch problem.	Ensure door latch is securing. Lubricate the door latch mechanism.
	Pressure Equilization Port (PEP) malfunctioning	The PEP is located behind the user interface but the backside of the port can be seen on the inside surface of the exterior door. If the opening or area directly in front of the opening is filled or covered with ice and/or frost, remove the blockage. Try closing and re-opening the door. If issues persist, call service.
<ul style="list-style-type: none"> • Difficult to close / open the inner door. 	Frost accumulated around inner door.	Defrost the inner door.
	Inner door latches damaged.	Call service.
<ul style="list-style-type: none"> • Vibration noise. • Rattling noise/ Loud noise. 	Unit is not level.	Check if the unit is installed in a level area free from vibration. (Refer to Section 7.3 in user manual)
	Loose side panels.	Check side panel screws, tighten them if necessary.
	Rubber tubing separators and/or compressor dampeners may have loosened.	Call service.

15 Connectivity Troubleshooting

This section is a guide to troubleshooting general connectivity problems.

Problem	Cause	Solution
<ul style="list-style-type: none"> Wireless Network (SSID) is not appearing in configuration 	Wrong network name	Verify the correct network name was provided.
	Network (SSID) is not visible (Not being broadcasted)	Verify the network (SSID) is visible (being broadcasted) using a mobile device. *Thermo Fisher Devices are not able to connect to SSID's that are not being broadcasted.
	Network is not compatible with the Thermo Fisher 802.11 AC network card	Verify with Local IT the network is compatible with the Thermo Fisher 802.11 AC network card. *Wireless 802.11 AC is compatible with 802.11 B, 802.11 G, and 802.11 N. *Freezers only support the 2.4GHz frequency. 5Ghz SSID is not supported.
	UI firmware	Contact service.
<ul style="list-style-type: none"> Freezer will not connect to a Wireless Network 	Wrong SSID and Password	Verify you are connecting to the correct network (SSID) and are entering the correct password. (Suggestion: attempt the same network connection via an alternate device, like a cell phone, laptop, or tablet.) Try restarting the freezer and re-attempt to establish the Wi-Fi connection.
	Network requires user acceptance or input via a web browser (like at a hotel)	Verify wireless access is not dependent on accessing a web page first. *Freezer is not compatible with Wi-Fi networks that require a login via webpage, such as many "guest" or "visitor" networks. Using such a network will cause the WiFi connection to fail.
	Enterprise security(802.1x)	Freezers do not support enterprise class authentication. Work with Local IT to get access to a network (SSID) with standard authentication.
	Weak Signal Strength (RSSI)	Verify Signal Strength (RSSI) is at least -65 dBm or better at the wireless interface of the device.
	MAC Address Filtering	Verify with local IT if MAC address filtering is in place. If MAC address filtering is in place, work with local IT to get the device added to an approved list. Navigate to Settings, Connectivity and WIFI to see the MAC address.

Problem	Cause	Solution
<ul style="list-style-type: none"> • Connectivity Options in freezer UI are greyed out and non-responsive • Device not connecting to the Cloud Portal 	Firewall ports closed	Verify with local IT that that ports 443, 123, and 80 are open to the Internet in the facility's firewall. Use the telnet app from a computer on the same network *Telnet is NOT enabled by default in Windows *telnet apps.thermofisher.com 443 *telnet apps.thermofisher.com 80 *telnet apps.thermofisher.com 123
	Proxy server	Verify with local IT that internet access is not gated behind a proxy server. *Thermo Fisher smart devices do not support proxy server configuration .
	Connect device to cloud using 3G/4G hotspot	Confirm if the Hotspot works at the location and allows internet connection using a laptop or tablet. If the device connects to the cloud, the issue is with the IT security. Work With Local IT to resolve the issue. If device does not connect through a hotspot, call service.
	UI firmware	Call service.

Note: *After resetting (like a unit factory reset) and reconnecting to InstrumentConnect, the freezer will appear as a new connection within the user's connected devices on InstrumentConnect. This is because a new security certificate will be established. The freezer will be unable to re-connect to the original device under the "old" security certificate.*

16 Warranty **Be sure to register your warranty online:**

www.thermofisher.com/labwarranty

THERMO FISHER SCIENTIFIC USA FREEZER WARRANTY FOR Revco RLE series, Forma 89000 series, HERAFreeze HLE series and Thermo Scientific TLE series

The Warranty Period starts two weeks from the date your equipment is shipped from our facility. This allows for shipping time so the warranty will go into effect at approximately the same time your equipment is delivered. The warranty protection extends to any subsequent owner during the warranty period.

During the first two years of the warranty period, component parts proven to be non-conforming in materials or workmanship will be repaired or replaced at Thermo Fisher Scientific's expense, labor included. The ULT Freezers include an additional three year warranty on the compressors, parts only, F.O.B. factory. Installation and calibration is not covered by this warranty agreement. The Technical Services Department must be contacted for warranty determination and direction prior to any work being performed. Expendable items, i.e., glass, filters, pilot lights, light bulbs and door gaskets are excluded from this warranty.

Replacement or repair of component parts or equipment under this warranty shall not extend the warranty to either the equipment or to the component part beyond the original two year warranty period. The Technical Services Department must give prior approval for the return of any components or equipment.

THIS WARRANTY IS EXCLUSIVE AND IN LIEU OF ALL OTHER WARRANTIES, WHETHER WRITTEN, ORAL, OR IMPLIED. NO WARRANTIES OF MERCHANTABILITY OR FITNESS FOR A PARTICULAR PURPOSE SHALL APPLY. Thermo shall not be liable for any indirect or consequential damages including, without limitation, damages relating to lost profits or loss of products.

Your local Thermo Fisher Scientific Sales Office is ready to help with comprehensive site preparation information before your equipment arrives. Printed instruction manuals carefully detail equipment installation, operation, and preventive maintenance.

If equipment service is required, please call your Technical Services Department at 1-800-438-4851 (USA and Canada). We're ready to answer your questions on equipment warranty, operation, maintenance, service, and special applications. Outside the USA, contact your local Thermo Fisher Scientific office or distributor for warranty information.

17 Warranty (International)

THERMO FISHER SCIENTIFIC FREEZER INTERNATIONAL WARRANTY FOR Revco RLE series, Forma 89000 series, HERAfreeze HLE series and Thermo Scientific TLE series

The Warranty Period starts two months from the date your equipment is shipped from our facility. This allows for shipping time so the warranty will go into effect at approximately the same time your equipment is delivered. The warranty protection extends to any subsequent owner during the warranty period. Dealers who stock our equipment are allowed an additional four months for delivery and installation, providing the warranty card is completed and returned to the Technical Services Department.

During the first two years of the warranty period, component parts proven to be non-conforming in materials or workmanship will be repaired or replaced at Thermo Fisher Scientific's expense, labor excluded. The ULT Freezers include an additional three year warranty on the compressors, parts only, F.O.B. factory. Installation and calibration is not covered by this warranty agreement. The Technical Services Department must be contacted for warranty determination and direction prior to any work being performed. Expendable items, i.e., glass, filters, pilot lights, light bulbs and door gaskets are excluded from this warranty.

Replacement or repair of component parts or equipment under this warranty shall not extend the warranty to either the equipment or to the component part beyond the original two year warranty period. The Technical Services Department must give prior approval for the return of any components or equipment.

THIS WARRANTY IS EXCLUSIVE AND IN LIEU OF ALL OTHER WARRANTIES, WHETHER WRITTEN, ORAL, OR IMPLIED. NO WARRANTIES OF MERCHANTABILITY OR FITNESS FOR A PARTICULAR PURPOSE SHALL APPLY. Thermo shall not be liable for any indirect or consequential damages including, without limitation, damages relating to lost profits or loss of products.

Your local Thermo Fisher Scientific Sales Office is ready to help with comprehensive site preparation information before your equipment arrives. Printed instruction manuals carefully detail equipment installation, operation, and preventive maintenance.

If equipment service is required, please contact your local Thermo Fisher Scientific office or local distributor.

We're ready to answer your questions on equipment warranty, operation, maintenance, service, and special applications. Outside the USA, contact your local Thermo Fisher Scientific office or distributor for warranty information.

Appendix A: Alarm Summary

Alarm Summary					
Alarm Message	Tone	Heart Status	Remote Alarm Event	Ringback*	Message Details
Warm Alarm Active	High	Red	Yes	Yes	<p>Message Header: Warm Alarm</p> <p>Message Details: The freezer temperature has exceeded the warm alarm set point of XX.X C. Prolonged door openings and warm product loading may cause warm alarms.</p> <p>Ticker Message: Warm Alarm active. Press bell icon for more information.</p>
Warm Alarm Inactive	None	Yellow	None	None	<p>Message Header: Warm Alarm Recovered</p> <p>Message Details: The freezer temperature has recovered from a warm alarm event. Select check box and press Acknowledge to clear this notification.</p> <p>Ticker Message: None</p>
Cold Alarm Active	High	Red	Yes	Yes	<p>Message Header: Cold Alarm</p> <p>Message Details: The freezer temperature has exceeded the cold alarm set point of XX.X C</p> <p>Ticker Message: Cold Alarm active. Press bell icon for more information.</p>
Cold Alarm Inactive	None	Yellow	None	None	<p>Message Header: Cold Alarm Recovered</p> <p>Message Details: The freezer temperature has recovered from a cold alarm event. Select check box and press Acknowledge to clear this notification.</p> <p>Ticker Message: None</p>
Door Open Ajar	High	Red	Yes	Yes	<p>Message Header: Door Open Alarm</p> <p>Message Details: Door open for greater than 3 minutes will cause door open alarm.</p> <p>Ticker Message: Door Open Alarm active. Press bell icon for more information.</p>
Door Open Recovered	None	Yellow	None	None	<p>Message Header: Door Open Recovered</p> <p>Message Details: Door open alarm has recovered. Select check box and press Acknowledge to clear this notification.</p> <p>Ticker Message: Door Open Alarm active. Press bell icon for more information.</p>

Alarm Summary					
Alarm Message	Tone	Heart Status	Remote Alarm Event	Ringback *	Message Details
System Battery Low	None	Yellow	None	None	<p>Message Header: System Battery Low</p> <p>Message Details: System battery is XX.XV. Recommend replacing battery. Contact customer service for replacement battery.</p> <p>Ticker Message: None</p>
System Battery PM Expiry	None	Yellow	None	None	<p>Message Header: System Battery Low</p> <p>Message Details: System battery is XX.XV. Recommend replacing battery. Contact customer service for replacement battery.</p> <p>Ticker Message: None</p>
BUS Battery Low	None	Yellow	None	None	<p>Message Header: BUS Battery Low</p> <p>Message Details: BUS battery is XX.XV. Recommend replacing battery. Contact customer service for replacement battery.</p> <p>Ticker Message: None</p>
BUS Battery PM Expiry	None	Yellow	None	None	<p>Message Header: Battery PM Expiry</p> <p>Message Details: Recommend to replace battery. Reset battery expiration time on XXX screen to clear this notification.</p> <p>Ticker Message: None</p>
Extreme Ambient	None	Yellow	None	None	<p>Message Header: Extreme Ambient Notification</p> <p>Message Details: Ambient temperature has exceeded the Extreme Ambient set point of XX.XC. Ensure room temperature is properly controlled.</p> <p>Ticker Message: None</p>
Control Probe Failure	High	Red	Yes	Yes	<p>Message Header: Control Probe Failure Alarm</p> <p>Message Details: Cannot display cabinet temperature. The freezer will continue to operate in full run mode. Contact customer service.</p> <p>Ticker Message: Control Probe Failure Alarm active. Press bell icon for more information.</p>
Control Probe Failure has been	None	Yellow	None	None	<p>Message Header: Control Probe Failure Recovered</p> <p>Message Details: Control Probe Failure Alarm has been cleared. Press the yellow triangle to clear this notification.</p> <p>Ticker Message: None</p>

Alarm Summary					
Alarm Message	Tone	Heart Status	Remote Alarm Event	Ringback*	Message Details
Heat Exchange Probe Failure	High	Red	Yes	Yes	<p>Message Header: Heat Exchanger Probe Failure Notification</p> <p>Message Details: The freezer will continue to operate with current freezer set points, but cabinet temperature variation will increase. Contact customer service.</p> <p>Ticker Message: Control Probe Failure Alarm active. Press bell icon for more information.</p>
Heat Exchange Probe Failure has been	None	Yellow	None	None	<p>Message Header: Heat Exchanger Probe Failure Recovered</p> <p>Message Details: Heat Exchange Probe Failure Alarm has been cleared. Press the yellow triangle to clear this notification.</p> <p>Ticker Message: None</p>
TC1-9 Failure	None	Yellow	None	None	<p>Message Header: TCXX Out of Range Notification</p> <p>Message Details: Information TC's has malfunctioned. This doesn't affect the performance of the unit. Contact service for further assistance.</p> <p>Ticker Message: None</p>
TC1-9 has been	None	Yellow	None	None	<p>Message Header: TCXX Out of Range Notification Recovered</p> <p>Message Details: Information TCXX has recovered. Select check box and press Acknowledge to clear this notification.</p> <p>Ticker Message: None</p>
Main to UI Lost Communication	High	Red	Yes	Yes	<p>Message Header: Lost Communication Alarm</p> <p>Message Details: A communication error has occurred within the system. Contact customer service.</p> <p>Ticker Message: Lost Communication Alarm Active. Press bell icon for more information.</p>
Main to UI Lost Communication Inactive	None	Yellow	None	None	<p>Message Header: Lost Communication Alarm Recovered</p> <p>Message Details: A communication error has recovered. Select check box and press Acknowledge to clear this notification.</p> <p>Ticker Message: None</p>

Alarm Summary					
Alarm Message	Tone	Heart Status	Remote Alarm Event	Ringback *	Message Details
BUS Lost Communication	High	Red	Yes	Yes	<p>Message Header: Backup System Communication Alarm</p> <p>Message Details: A communication error has occurred within the back up system. Contact customer service.</p> <p>Ticker Message: Bus Lost Communication Alarm Active. Press bell icon for more information.</p>
BUS Lost Communication Inactive	None	Yellow	None	None	<p>Message Header: BUS Lost Communication Alarm Recovered</p> <p>Message Details: A BUS communication error has recovered. Select check box and press Acknowledge to clear this notification.</p> <p>Ticker Message: None</p>
Failure to Reach Set point	None	Yellow	None	None	<p>Message Header: Unable to Reach Set point Notification</p> <p>Message Details: Door openings or product loading may cause this notification. Allow unit to stabilize. If condition persists, contact customer service</p> <p>Ticker Message: None</p>
Compressor Temperature	None	Yellow	None	None	<p>Message Header: Compressor Temperature Notification</p> <p>Message Details: A refrigeration system temperature has exceeded the compressor temperature set point of XX.X C. Contact customer service.</p> <p>Ticker Message: None</p>
Inefficient Buck / Boost	None	Yellow	None	None	<p>Message Header: Inefficient buck / boost notification</p> <p>Message Details: Freezer input voltage is out of range. Ensure proper supply voltage is applied. If unable to clear this notification, contact customer service.</p> <p>Ticker Message: None</p>
Power Failure Alarm	High	Red	Yes	Yes	<p>Message Header: Power Failure Alarm</p> <p>Message Details: Unit in power failure mode. Display operating on battery power. Check unit plug, unit circuit breaker in the ON position, and supply voltage.</p> <p>Ticker Message: Power Failure Alarm Active. Press bell icon for more information.</p>

Alarm Summary					
Alarm Message	Tone	Heart Status	Remote Alarm Event	Ringback*	Message Details
Power Failure Inactive	None	Yellow	None	None	<p>Message Header: Power Failure Recovered</p> <p>Message Details: Power has been restored. Press the yellow triangle to clear this notification.</p> <p>Ticker Message: None</p>
Clean Filter Active	None	Yellow	None	None	<p>Message Header: Clean Filter Notification</p> <p>Message Details: Recommend to clean the filter and condenser. If unable to clear notification, contact customer service.</p> <p>Ticker Message: None</p>
Refrigeration System Failure	High	Red	Yes	Yes	<p>Message Header: System Refrigeration Failure Alarm</p> <p>Message Details: An error has occurred within the refrigeration system. Contact customer service.</p> <p>Ticker Message: System Refrigeration Failure Alarm. Press bell icon for more information</p>
Refrigeration System Failure Inactive	High	Red	None	None	<p>Message Header: System Refrigeration Failure Recovered</p> <p>Message Details: An error in refrigeration system has been recovered. Select check box and press Acknowledge to clear this notification.</p> <p>Ticker Message: None</p>
Wrong Power Alarm	High	Red	Yes	None, constant audible	<p>Message Header: Wrong Power Alarm</p> <p>Message Details: The unit has detected the wrong power connected. Please verify the proper voltage.</p> <p>Ticker Message: Wrong Power Alarm. Press bell icon for more information.</p>
Wrong Power Alarm Inactive	None	Yellow	None	None	<p>Message Header: Wrong Power Recovered</p> <p>Message Details: Wrong Power has been recovered. Select check box and press Acknowledge to clear this notification.</p> <p>Ticker Message: None</p>
Wrong Model Alarm	High	Red	Yes	None, constant audible	<p>Message Header: Invalid Control Model Alarm</p> <p>Message Details: Invalid Control Model Alarm. Contact service to ensure the correct model is selected for the system to avoid cargo loss.</p> <p>Ticker Message: Invalid Control Model Alarm. Press bell icon for more information.</p>

Alarm Summary					
Alarm Message	Tone	Heart Status	Remote Alarm Event	Ringback *	Message Details
Wrong Model Alarm Inactive	None	Yellow	None	None	<p>Message Header: Invalid Control Model Recovered</p> <p>Message Details: Invalid Control Model has been recovered. Select check box and press Acknowledge to clear this notification.</p> <p>Ticker Message: None</p>
Firmware Build Incompatible	High	Red	Yes	Yes	<p>Message Header: Firmware Build Incompatible Alarm</p> <p>Message Details: Firmware build indicates incompatibility that can result in modules to be non-coherent.</p> <p>Ticker Message: Firmware build incompatible. Press bell icon for more information.</p>
Firmware Build Incompatible Inactive	None	Yellow	None	None	<p>Message Header: Firmware Build Incompatibility Recovered</p> <p>Message Details: Firmware build Incompatibility recovered. Select check box and press Acknowledge to clear this notification.</p> <p>Ticker Message: None</p>
Water Temperature alarm	None	Yellow	None	None	<p>Message Header: Water Temperature Alarm</p> <p>Message Details: Water inlet Temperature out of range</p> <p>Ticker Message: None</p>
Low Water flow Alarm	High	Red	Yes	Yes	<p>Message Header: Water flow outside allowable water flow conditions.</p> <p>Message Details: Water flow rate must be within 1.9 - 6.06 LPM (0.5 - 1.6 GPM) to provide the required system cooling environment</p> <p>Ticker Message: Low water flow detected. Check water supply</p>
Low Water flow Alarm Inactive	None	Yellow	None	None	<p>Message Header: Low Water flow Recovered</p> <p>Message Details: Low water flow recovered on the unit</p> <p>Ticker Message: None</p>
System Battery Disconnected Alarm	High	Red	Yes	Yes	<p>Message Header: System Battery Disconnected</p> <p>Message Details: System Battery Disconnected</p> <p>Ticker Message: System Battery has been Disconnected. Press Bell icon for more information</p>

Alarm Summary					
Alarm Message	Tone	Heart Status	Remote Alarm Event	Ringback [*]	Message Details
System Battery Disconnected Has been	None	Yellow	None	None	Message Header: System Battery Connected Message Details: System Battery Connected Ticker Message: None
Bus Battery Disconnected Alarm	High	Red	Yes	Yes	Message Header: Bus Battery Disconnected Message Details: Bus Battery Disconnected Ticker Message: Bus Battery has been Disconnected. Press Bell icon for more information
Bus Battery Disconnected Has been	None	Yellow	None	None	Message Header: Bus Battery Connected Message Details: Bus Battery Connected Ticker Message: None
Bus Probe Fail Alarm	High	Red	Yes	Yes	Message Header: Bus Probe Failure Message Details: Bus Probe Fail has been detected Ticker Message: Bus Probe Fail Alarm active. Press Bell icon for more information
Bus Probe Fail Alarm Has been	None	Yellow	None	None	Message Header: Bus Probe Failure Message Details: Bus Probe Fail has been recovered Ticker Message: None

*Ringback refers to the audible alarm activating again after the user presses the Snooze button. The time can be set in the 'Snooze Timeout' option in the Alarm Settings screen.

Appendix B: Event Log Detail

Event Log Entry Detail	
Item	Message
System Parameter Change	Header: Control Settings Change Role: Logged in personnel or anonymous in full access mode Mode: Full access or secured Message Detail: The following parameters has been changes to: Parameter 1 from: XX.XX to XX.XX
User Interface Parameter Change	Header: User Interface Settings Change Role: Logged in personnel or anonymous in full access mode Mode: Full access or secured Message Detail: The following parameters has been changes to: Parameter 1 from: XX.XX to XX.XX
Door Open	Header: Door Open Role: Logged in personnel or blank if not HID system
Door Close	Header: Door Close Role: Logged in personnel or blank if not HID system
User Login	Header: User jsmith has logged in
User Logout	Header: User jsmith has logged out
Door History Reset	Header: Door History Reset Role: Logged in personnel or anonymous in full access mode Mode: Full access or secured Message Detail: Door Usage history has been reset
Temperature Excursion Reset	Header: Temperature Excursion History Reset Role: Logged in personnel or anonymous in full access mode Message Detail: Temperature Excursion history has been reset
Add User Event	Header: Add a User to User database Role: Logged in personnel or anonymous in full access mode Mode: Full access or secured Message Detail: User jsmith has been added to user database
Remove User Event	Header: Remove a User to User database Role: Logged in personnel or anonymous in full access mode Mode: Full access or secured Message Detail: User jsmith has been removed to user database
Edit User Event	Header: Edit a User to User database Role: Logged in personnel or anonymous in full access mode Mode: Full access or secured Message Detail: User jsmith details has been modified.

Event Log Entry Detail	
Item	Message
Buck / Boost Change Event	<p>Header: Buck / Boost status Change</p> <p>Message Detail: Buck / Boost changed from X to Y Line Input Voltage at time of change is Compensated Voltage at time of change is</p>
BUS Injection	Header: BUS Injection on or off
BUS Pressure Switch	Header: BUS Pressure Switch active or inactive
Reset to Factory default	<p>Header: Reset to Factory Defaults</p> <p>Role: Logged in personnel or anonymous in full access mode</p> <p>Mode: Full access or secured</p> <p>Message Detail: System has been restored to factory defaults</p>
Powered Up Event	<p>Header: Softswitch Power Up event</p> <p>Role: Logged in personnel or anonymous in full access mode</p> <p>Mode: Full access or secured</p> <p>Message Detail: System has been user turned on</p>
Powered Down Event	<p>Header: Softswitch Power Down event</p> <p>Role: Logged in personnel or anonymous in full access mode</p> <p>Mode: Full access or secured</p> <p>Message Detail: System has been user turned off</p>
HID Access	Header: User Jsmith has accessed the unit
Invalid HID	Header: Invalid HID tried to access unit
Export Event	<p>Header: (Temperature, temperature and event log or pdf report) has been exported</p> <p>Role: Logged in personnel or anonymous in full access mode</p> <p>Mode: Full access or secured</p> <p>Message Detail: (Temperature, temperature and event log or pdf report) has been exported Date Range of export is from X to Y File format exported is (pdf, csv or PUC)</p>
Configuration Import / Export	<p>Header: Configuration import or export initiated</p> <p>Role: Logged in personnel or anonymous in full access mode</p> <p>Mode: Full access or secured</p> <p>Message Detail: Following items has been imported or exported to USB</p> <ul style="list-style-type: none"> - Contact info - User database - System and User Interface settings - Temperature and event log history

Appendix C: City Time Zone

Time specified in the time zone indicates the difference with UTC.

Time Zone	City
(Africa +00:00)	ElAaiun
	Freetown
	Lome
	Abidjan
	Accra
	Bamako
	Banjul
	Bissau
	Casablanca
	Conakry
	Dakar
	Monrovia
	Nouakchott
	Ouagadougou
(Africa +01:00)	Algiers
	Bangui
	Brazzaville
	Ceuta
	Douala
	Kinshasa
	Lagos
	Libreville
	Luanda
	Malabo
	Ndjamena
	Niamey
	Porto-Novo
	Sao_Tome
Tunis	

Time Zone	City
(Africa +02:00)	Gaborone
	Harare
	Johannesburg
	Khartoum
	Kigali
	Lubumbashi
	Lusaka
	Maputo
	Blantyre
	Bujumbura
	Cairo
	Maseru
	Mbabane
	Tripoli
Windhoek	
(Africa +03:00)	Juba
	Kampala
	AddisAbaba
	Asmara
	DaresSalaam
	Djibouti
	Mogadishu
	Nairobi
(America +00:00)	Danmarkshavn
(America -01:00)	Scoresbysund

Time Zone	City
(America -02:00)	Noronha
(America -03:00)	Araguaina
	Bahia
	Belem
	Cayenne
	Fortaleza
	Godthab
	Maceio
	Miquelon
	Montevideo
	Paramaribo
	Recife
	Santarem
	SaoPaulo
(America -03:30)	StJohns
	Anguilla
(America -04:00)	Antigua
	Aruba
	Asuncion
	Barbados
	Blanc-Sablon
	BoaVista
	CampoGrande
	Caracas
	Cuiaba
	Curacao
	Dominica
	GlanceBay
	GooseBay
	GrandTurk

Time Zone	City
(America -04:00)	Grenada
	Guadeloupe
	Guyana
	Halifax
	Kralendijk
	LaPaz
	LowerPrinces
	Manaus
	Marigot
	Martinique
	Moncton
	Montserrat
	PortofSpain
	PortoVelho
	PuertoRico
	Santiago
	SantoDomingo
	StBarthelemy
	StKitts
	StLucia
	StThomas
	StVincent
	Thule
	Tortola
(America -05:00)	Atikokan
	Bogota
	Cancun
	Cayman
	Detroit
	Eirunepe
	Guayaquil
	Havana

Appendix C: City Time Zone

Time Zone	City
(America -05:00)	Iqaluit
	Jamaica
	Lima
	Nassau
	NewYork
	Nipigon
	Panama
	Pangnirtung
	Port-au-Prince
	RioBranco
	ThunderBay
	Toronto
	(America -06:00)
Belize	
Chicago	
CostaRica	
ElSalvador	
Guatemala	
Managua	
Matamoros	
Menominee	
Merida	
MexicoCity	
Monterrey	
RainyRiver	
RankinInlet	
Regina	
Resolute	
SwiftCurrent	
Tegucigalpa	
Winnipeg	
(Antarctica +06:00)	Vostok
(Antarctica +07:00)	Davis
(Antarctica +10:00)	DumontDURville
(Antarctica +11:00)	Casey
(Antarctica +12:00)	McMurdo
(Antarctica +06:00)	Vostok

Time Zone	City
(America -07:00)	Boise
	CambridgeBay
	Chihuahua
	Creston
	DawsonCreek
	Denver
	Edmonton
	FortNelson
	Hermosillo
	Inuvik
	Mazatlan
	Ojinaga
	Phoenix
Yellowknife	
(America -08:00)	Dawson
	LosAngeles
	Tijuana
	Vancouver
	Whitehorse
(America -09:00)	Anchorage
	Juneau
	Metlakatla
	Nome
	Sitka
	Yakutat
(America -10:00)	Adak
(Antarctica +00:00)	Troll
(Antarctica +03:00)	Syowa
(Antarctica +05:00)	Mawson
(Asia +04:00)	Baku
	Dubai
	Muscat
	Tbilisi
	Yerevan
(Asia +04:30)	Kabul

Time Zone	City
(Antarctica -03:00)	Palmer
	Rothera
(Arctic +01:00)	Longyearbyen
(Asia +02:00)	Amman
	Beirut
	Damascus
	Famagusta
	Gaza
	Hebron
	Jerusalem
(Asia +03:00)	Aden
	Baghdad
	Bahrain
	Kuwait
	Riyadh
(Asia +03:30)	Tehran
(Asia +06:30)	Yangon
(Asia +07:00)	Bangkok
	Barnaul
	HoChiMinh
	Hovd
	Jakarta
	Krasnoyarsk
	Novokuznetsk
	Novosibirsk
	PhnomPenh
	Pontianak
	Tomsk
	Vientiane

Time Zone	City
(Asia +05:00)	Aqtau
	Aqtobe
	Ashgabat
	Dushanbe
	Karachi
	Oral
	Samarkand
	Tashkent
	Yekaterinburg
(Asia +05:30)	Colombo
	Kolkata
(Asia +05:45)	Kathmandu
(Asia +06:00)	Almaty
	Dhaka
	Omsk
	Qyzylorda
	Thimphu
	Urumqi
(Asia +09:00)	Chita
	Dili
	Jayapura
	Khandyga
	Seoul
	Yakutsk
(Asia +10:00)	Ust-Nera
	Vladivostok
(Asia +11:00)	Magadan
	Sakhalin
	Srednekolymsk

Appendix C: City Time Zone

Time Zone	City
(Asia +08:00)	Brunei
	Choibalsan
	HongKong
	Irkutsk
	KualaLumpur
	Kuching
	Macau
	Makassar
	Manila
	Shanghai
	Singapore
	Taipei
	Ulaanbaatar
(Asia +08:30)	Pyongyang
(Australia +08:45)	Eucla
(Australia +09:30)	Adelaide
	BrokenHill
	Darwin
(Australia +10:00)	Brisbane
	Currie
	Hobart
	Lindeman
	Melbourne
	Sydney
(Europe +00:00)	Dublin
	Guernsey
	IsleofMan
	Jersey
	Lisbon
	London
(Europe +01:00)	Amsterdam
	Andorra
	Belgrade
	Berlin
	Bratislava
	Brussels
	Budapest
	Busingen
	Copenhagen
	Gibraltar
	Ljubljana
	Luxembourg
	Madrid

Time Zone	City
(Asia +12:00)	Anadyr
	Kamchatka
(Atlantic +00:00)	Canary
	Faroe
	Madeira
	Reykjavik
	StHelena
(Atlantic -01:00)	Azores
	CapeVerde
(Atlantic -02:00)	SouthGeorgia
(Atlantic -03:00)	Stanley
(Atlantic -04:00)	Bermuda
(Australia +08:00)	Perth
(Europe +01:00)	Malta
	Monaco
	Oslo
	Paris
	Podgorica
	Prague
	Rome
	SanMarino
	Sarajevo
	Skopje
	Stockholm
	Tirane
	Vaduz
	Vatican
	Vienna
	Warsaw
Zagreb	
Zurich	
(Europe +02:00)	Athens
	Bucharest
	Chisinau
	Helsinki
	Kaliningrad
	Kiev
	Mariehamn
	Riga
	Sofia
	Tallinn
	Uzhgorod
Vilnius	
Zaporozhye	

Time Zone	City
(Europe +03:00)	Istanbul
	Kirov
	Minsk
	Moscow
	Simferopol
	Volgograd
(Europe +04:00)	Astrakhan
	Samara
	Ulyanovsk
(Indian +03:00)	Antananarivo
	Comoro
	Mayotte
(Indian +04:00)	Mahe
	Mauritius
	Reunion
(Indian +05:00)	Kerguelen
	Maldives
(Indian +06:00)	Chagos
(Indian +06:30)	Cocos
(Indian +07:00)	Christmas
(Pacific +09:00)	Palau
(Pacific +10:00)	Chuuk
	Guam
	PortMoresby
	Saipan
(Pacific -10:00)	Honolulu
	Johnston
	Rarotonga
	Tahiti
(Pacific -11:00)	Midway
	Niue
	PagoPago

Time Zone	City
(Pacific +11:00)	Bougainville
	Efate
	Guadalcanal
	Kosrae
	Norfolk
	Noumea
	Pohnpei
(Pacific +12:00)	Auckland
	Fiji
	Funafuti
	Kwajalein
	Majuro
	Nauru
	Tarawa
	Wake
	Wallis
(Pacific +12:45)	Chatham
(Pacific +13:00)	Apia
	Enderbury
	Fakaofu
	Tongatapu
(Pacific +14:00)	Kiritimati
(Pacific -06:00)	Easter
	Galapagos
(Pacific -08:00)	Pitcairn
(Pacific -09:00)	Gambier
(Pacific -09:30)	Marquesas

WEEE Compliance

WEEE Compliance. This product is required to comply with the European Union's Waste Electrical & Electronic Equipment (WEEE) Directive 2012/19/EU. It is marked with the following symbol. Thermo Fisher Scientific has contracted with one or more recycling/disposal companies in each EU Member State, and this product should be disposed of or recycled through them. Further information on our compliance with these Directives, the recyclers in your country, and information on Thermo Scientific products which may assist the detection of substances subject to the RoHS Directive are available at www.thermofisher.com/WEEERoHS.

Great Britain



WEEE Konformität. Dieses Produkt muss die EU Waste Electrical & Electronic Equipment (WEEE) Richtlinie 2012/19/EU erfüllen. Das Produkt ist durch folgendes Symbol gekennzeichnet. Thermo Fisher Scientific hat Vereinbarungen getroffen mit Verwertungs-/Entsorgungsanlagen in allen EU-Mitgliederstaaten und dieses Produkt muss durch diese Firmen wiederverwertet oder entsorgt werden. Mehr Informationen über die Einhaltung dieser Anweisungen durch Thermo Scientific, die Verwerter und Hinweise die Ihnen nützlich sein können, die Thermo Fisher Scientific Produkte zu identifizieren, die unter diese RoHS-Anweisung fallen, finden Sie unter www.thermofisher.com/WEEERoHS.

Deutschland

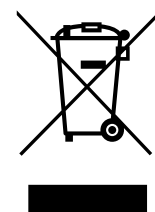

Conformità WEEE. Questo prodotto deve rispondere alla direttiva dell'Unione Europea 2012/19/EU in merito ai Rifiuti degli Apparecchi Elettrici ed Elettronici (WEEE).

È marcato col seguente simbolo. Thermo Fisher Scientific ha stipulato contratti con una o diverse società di riciclaggio/smaltimento in ognuno degli Stati Membri Europei. Questo prodotto verrà smaltito o riciclato tramite queste medesime. Ulteriori informazioni sulla conformità di Thermo Fisher Scientific con queste Direttive, l'elenco delle ditte di riciclaggio nel Vostro paese e informazioni sui prodotti Thermo Scientific che possono essere utili alla rilevazione di sostanze soggette alla Direttiva RoHS sono disponibili sul sito www.thermofisher.com/WEEERoHS.

Italia

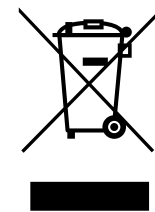

Conformité WEEE. Ce produit doit être conforme à la directive européenne (2012/19/EU) des Déchets d'Équipements Électriques et Électroniques (DEEE). Il est marqué par le symbole suivant. Thermo Fisher Scientific s'est associé avec une ou plusieurs compagnies de recyclage dans chaque état membre de l'union européenne et ce produit devrait être collecté ou recyclé par celles-ci. Davantage d'informations sur la conformité de Thermo Fisher Scientific à ces directives, les recycleurs dans votre pays et les informations sur les produits Thermo Fisher Scientific qui peuvent aider la détection des substances sujettes à la directive RoHS sont disponibles sur www.thermofisher.com/WEEERoHS.

France

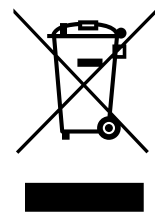

Important

For your future reference and when contacting the factory, please have the following information readily available:

Model Number: _____

Serial Number: _____

Date Purchased: _____

The above information can be found on the dataplate attached to the equipment. If available, please provide the date purchased, the source of purchase (manufacturer or specific agent/rep organization), and purchase order number.

IF YOU NEED ASSISTANCE:

Thermo Scientific products are backed by a global technical support team ready to support your applications. We also offer cold storage accessories, including remote alarms, temperature recorders and validation services. Visit www.thermofisher.com or call:

USA/Canada	+1 866 984 3766	China	+800 810 5118 (or) +400 650 5118
France	+33 (0)2 2803 2180	India	+91 22 6716 2200
Germany	+49 0800 1536 376	Japan	0120-477-392
UK/Ireland	+44 (0) 870 609 9203 opt 3		

For country contact information not listed, refer to the Contact Us section of www.thermofisher.com

Thermo Fisher Scientific Inc.

275 Aiken Road
Asheville, NC 28804
United States
www.thermofisher.com

thermoscientific

328398H01 Rev. H