

diagenode

Innovating Epigenetic Solutions

# Bioruptor<sup>®</sup> Sonication System

## USER MANUAL

VERSION 2.1

User Manual for the Bioruptor Family  
of Sonication Systems and Accessories

- UCD-200 — Bioruptor Standard
- UCD-300 — Bioruptor Plus
- UCD-400 — Bioruptor Twin
- UCD-500 — Bioruptor XL



# Guarantee

## Limited one year global warranty

Diagenode guarantees all products from any manufacturing defects as we rigorously test all products to meet strict quality standards. Diagenode warrants that all standard components of its instruments will be free of defects in materials and workmanship for a period of one (1) year from the date that the warranty period begins, unless the original quotation or accompanying documentation states a different warranty period. All warranty periods begin on the date of delivery and apply only to the first purchaser of the product. If a manufacturing defect arises and a valid claim is received within the warranty period, Diagenode, at its discretion, will repair or replace the product in accordance with the warranty terms and conditions stated herein. In case of repair or replacement of a product under warranty, Diagenode will cover the expenses to return the repaired or replacement product.

This warranty covers only manufacturing defects and does not cover any damage caused by misuse, lack of compliance to recommendations stated in the manual, neglect, accidents, abrasion, or exposure to extreme temperatures, chemical solvents, or acids. We strongly recommend that maintenance or repairs of Diagenode's products are performed by our approved Diagenode service center. Improper or incorrectly performed maintenance or repairs will void the warranty.

---

## Technical Assistance

Phone: +32 (0) 4 364 20 69  
Fax: +32 (0) 4 364 20 51  
info@diagenode.com

### Diagenode

CHU B34  
Tour GIGA 3ème étage  
Avenue de l'hôpital, 1  
4000 Liège  
Belgium

## Ordering Information

### Diagenode s.a. Europe, Asia & Australia

CHU, Tour GIGA B34, 3rd Floor  
Avenue de l'Hôpital, n°1  
4000 Sart-Tilman, Liège  
BELGIUM

Phone: +32 (0) 4 364 20 50  
Fax: +32 (0) 4 364 20 51  
Email: info@diagenode.com

### Diagenode Inc. North America

400 Morris Avenue, Suite 101  
Denville, NJ 07834 USA

Phone : +1 862 209-4680  
Fax: +1 862 209-4681  
Email: orders.na@diagenode.com

# Contents

<b>Warnings</b> .....	<b>4</b>
<b>Introduction</b> .....	<b>5</b>
<b>Bioruptor Technical Specifications</b> .....	<b>5</b>
<b>Getting to Know Your Bioruptor</b> .....	<b>6</b>
<b>Bioruptor Components</b> .....	<b>6</b>
Waterbath .....	6
Motorized lid .....	7
Tube holders .....	7
Sound-Proof Box .....	7
Power Supply Adapter .....	7
<b>Equipment Installation</b> .....	<b>8</b>
Installing the Bioruptor UCD-200 .....	9
Installing the Bioruptor UCD-300 and UCD-400 .....	10
Installing the Bioruptor XL .....	11
<b>Control Units</b> .....	<b>13</b>
UCD-200 .....	13
UCD-300 and UCD-400 .....	13
Controlling the Sonication .....	13
UCD-300 Digital Timer .....	13
UCD-400 Digital Timer .....	14
Overheat Shutdown for UCD-300 and UCD-400 .....	14
Bioruptor XL .....	15
Controlling the Sonication .....	15
<b>Using Adaptors and Holding Plates</b> .....	<b>16</b>
Adaptor Tube Units .....	16
Holding Plates .....	17
<b>Sonication Protocols</b> .....	<b>17</b>
Sample Protocol for DNA Shearing .....	17
Bioruptor Sample Protocols .....	18
<b>Optimal Sonication Parameters</b> .....	<b>19</b>
Bioruptor: Chromatin Shearing Example .....	20
Quick Overview: Tips for Starting a Successful Sonication .....	20
<b>Troubleshooting</b> .....	<b>21</b>
<b>Bioruptor: Chromatin Shearing FAQs</b> .....	<b>21</b>
<b>Bioruptor Packing Instructions</b> .....	<b>22</b>
<b>Related Products</b> .....	<b>23</b>
Antibodies .....	23
ChIP Kits .....	23
DNA Methylation Kits .....	23
<b>Ordering Information</b> .....	<b>Back Cover</b>

# Warnings

These instructions do not necessarily cover all the details of possible equipment variation, installation, or operation. Trouble-free and safe operation of the instrument is dependent on proper transport and installation by qualified personnel. READ ALL THE FOLLOWING PRECAUTIONS BEFORE INSTALLING AND USING THE INSTRUMENT.

## General warnings

- Never use the instrument near flammable gases to avoid risk of fire.
- Never use the instrument in an environment of extreme dust.
- Do not place instrument in direct sunlight.



- Handle the waterbath component of the instrument with extreme caution. The waterbath unit contains the ultrasound emitter which is composed of fragile mechanisms. To empty the water tank, use the plastic pump provided with the instrument. Do not move the unit to pour out the water.
- The water in the waterbath must be kept at 4°C (40°F). Sonication transfers energy to the waterbath which leads to a temperature increase. To retain the integrity of biological samples and to prevent the Bioruptor from damage, change the water in the waterbath as frequently as possible OR purchase our optional water cooler cooling system (Cat. No. BioAcc-cool).
- Do not turn on the instrument without water. This will damage the instrument.
- Do not leave the instrument unattended for more than 20 minutes at a time.
- Make sure water level is always at the level indicated within the waterbath. Deviation may cause damage.
- Use the 15 ml adaptor with the aluminium O-ring or scratches will occur on the tank bottom.

## Use of Bioruptor by pregnant women

Exposure to 20kHz sound waves has not been shown to be harmful to human health. However, we would recommend avoiding unnecessary exposure. Diagenode recommends that pregnant women should not be exposed to 20kHz wave lengths for a long period of time.

## Noise level measurements & precautions

CEE noise data is not applicable to the Bioruptor's ultrasound emitter as no tests have been conducted on similar devices to date. See listed noise levels (as measured in the Accredited Acoustics Laboratory) and precautions for the Bioruptor:

**Leq = noise level in dBA = 78.4 dB**

**Lmax = dB Peak = 87.6 dB**

### 1. Exposure limit value

The exposure limit value is the maximum amount of noise an employee may be exposed to on any single day (8 hours). Exposure beyond this limit presents a high risk to the user.

**LEXPOSURE, 8h = 87 dB(A)**

**PPEAK = 200 Pa (140 dB(C) referring to 20 µPa)**

### 2. Upper exposure Action value

The exposure action value is the upper daily limit of noise exposure. Exposure beyond this value requires employers to take action to limit user exposure.

**LEXPOSURE, 8h = 85 dB(A)**

**PPEAK = 140 Pa (137 dB(C) referring to 20 µPa)**

### 3. Lower exposure action value

**LEXPOSURE, 8h = 80 dB(A)**

**PPEAK = 112 Pa (135 dB(C) referring to 20 µPa)**

# Introduction

The Diagenode Bioruptor uses a gentle method of sonication to retain the integrity of DNA and/or biological complexes, including chromatin, protein-protein binding, protein-DNA complexes, and other biochemical and biological assay systems. The Bioruptor Sonication System uses a waterbath to generate these indirect sonication waves, which emanate from an ultrasound element below the water tank. Because the system is gentler than other sonicators, many customers report better and more consistent results with the Bioruptor than with harsher sonication methods. Multiple closed tubes can be sonicated together and the continuous rotation of tubes allows even distribution of the energy for efficient sonication. The Bioruptor enables automation of sonication, guaranteeing higher reproducibility of results.

## What is the effect of ultrasound on biological samples?

The Bioruptor sonication system uses ultrasound to create focused mechanical stress to lyse cells or shear DNA or chromatin. The ultrasound waves pass through the sample, expanding and contracting liquid. During expansion, negative pressures pull the molecules away from one another and form a cavity or bubble in a process called cavitation. The bubble continues to absorb energy until it can no longer sustain itself and then implodes, producing intense focused shearing forces, which disperses or breaks biomolecules. Also, the fragmentation of DNA takes place as a consequence of this mechanical stress or shear from the bubbles.

With the Bioruptor, the entire volume of water present in the waterbath is exposed to ultrasound, allowing the samples in the tubes to be efficiently sonicated. For larger tubes (15 ml or 50 ml), the transfer of the ultrasound to the tubes is facilitated by a metallic bar in contact with the sample. This metallic bar is not a probe (no corrosion problems) but “reflects” the ultrasound originated from the waterbath and improves the sample sonication efficiency by a patented resonance system (See Figure 1).

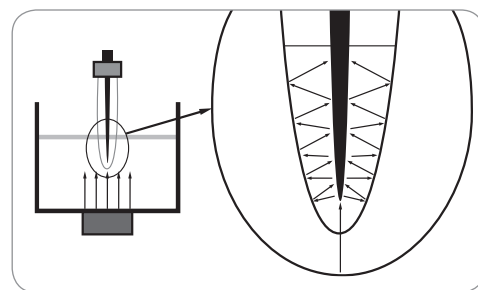

Fig 1. Propagation in 15ml /50ml tubes

## Bioruptor Technical Specifications

	Bioruptor UCD-200	Bioruptor UCD-300	Bioruptor UCD-400	Bioruptor UCD-500
Ultrasonic Wave Frequency	20kHz	20kHz	20kHz	20kHz
Ultrasonic Wave Output Power (switchable)	160, 200, 320W	160, 320W	160, 200, 320W	130, 200, 250, 300W
Power Supply	100V, 50/60Hz, 4.2A	100V, 50/60Hz, 4.2A	230V, 50/60Hz, 2.1A	240V, 50/60Hz, 3.2A
Control Unit Dimensions	150w x 300d x 195h mm	150w x 300d x 195h mm	150w x 300d x 195h mm	400w x 260d x 160h mm
Sonication Unit Dimensions	117w x 190d x 300h mm	350w x 260d x 150h mm	350w x 260d x 150h mm	320w x 180d x 280h mm
Noise Reduction Box Dimensions	200w x 260d x 360h mm	200w x 260d x 360h mm	200w x 260d x 360h mm	400w x 300d x 520h mm
Waterbath Volume	800cc	800cc	800cc	1800cc
Number of Samples Processed Simultaneously	12 x 0.5 ml, 6 x 1.5 ml, 6 x 10 ml, 6 x 15 ml, 3 x 50 ml	12 x 0.5 ml, 6 x 1.5 ml, 6 x 10 ml, 6 x 15 ml, 3 x 50 ml	24 x 0.5 ml, 12 x 1.5 ml, 12 x 10 ml, 12 x 15 ml, 6 x 50 ml	48 x 0.5 ml, 24 x 1.5 ml, 24 x 10 ml, 24 x 15 ml, 12 x 50 ml
Attachment Unit	Available for 0.5–1.5, 10, 15 & 50 ml tubes	Available for 0.5–1.5, 10, 15 & 50 ml tubes	Available for 0.5–1.5, 10, 15 & 50 ml tubes	Available for 0.5–1.5, 10, 15 & 50 ml tubes
Power Supply Adapter	26 x 16 x 18 outside the U.S.	26 x 16 x 18 outside the U.S.	26 x 16 x 18 outside the U.S.	26 x 16 x 18 outside the U.S.
Transformer 220/100V Dimensions	170w x 130d x 140h mm	Internal	Internal	Internal
Interval Timer	0–60 sec. or min. (on/off cycles)	0–60 sec. or min. (on/off cycles)	0–60 sec. or min. (on/off cycles)	0–99 sec. or min. (on/off cycles)
Total Timer	Max 15 min. (analog)	Max 15 min. (digital)	Max 15 min. (digital)	Max 15 min. (digital)
Total Weight	22.6Kg	20Kg	30Kg	32.5Kg

# Getting to Know Your Bioruptor

## Bioruptor Components



**Control Unit**



**Waterbath**



**Motor Lid**



**Sound-Proof Box**



**Power Cable**



**Control Unit Cable**



**Accessory Example**



**Power Supply Adaptor**  
(only outside the U.S.)

## Waterbath

The waterbath is a critical component of the instrument. The generators below the tank produce ultrasonic waves which are then transferred through water. The waterbath requires special handling and care as described below.

### Handling

The waterbath must remain upright at all times, especially when moved. Tilting the waterbath or handling roughly may damage the fragile ultrasound emitter component, resulting in a substantial drop in sonication efficiency. If transportation of the apparatus is required after initial set-up, it is imperative to keep the tank at a right angle to the ground during the transport at all times.

### Water level and quality

The level of the water has been optimized and should always reach the blue line (sticker on the wall of the tank). Tap water or distilled water can be used to fill the tank.

### Water temperature

The water in the waterbath must be kept at 4°C (40°F). Ultrasonic waves produced by the Bioruptor generate heat. To ensure preservation of the samples and to prevent damage to the instrument, it is necessary to start the sonication process with cold water. Diagenode suggests maintaining the waterbath temperature during sonication by either adding ice throughout the run (manual temperature control) or by connecting the system to a circulating water cooling system (Cat. No. BioAcc-cool) for automatic temperature control.



Waterbath

**Manual temperature control**

A “pre-cooling” of the Bioruptor’s tank 15 minutes before starting the first round of sonication is advised. This prevents the water from heating too quickly due to thermal inertia (i.e. when the tank and the ultrasound generating elements are stored at room temperature). To pre-cool, simply add crushed ice and then fill with cold water up to the indicated level (blue line or sticker). The crushed ice floating in the water should not exceed 0.5cm and the total water level (water and ice) should be exactly at the indicated water level. We advise keeping a 4°C stock of water for the process. At the end of a typical sonication time (10 minutes, cycles of 30 seconds “ON” and 30 seconds “OFF”), the temperature in the waterbath should be below 10°C.

Note: You may permanently install the Bioruptor in a cold room, though this is not sufficient to avoid the temperature increases during sonication. The cold room would only eliminate the need for the “pre-cooling” step described above.

**Automatic temperature control**

A refrigerated circulation bath can be used to guarantee the automatic temperature control of the waterbath during the entire sonication process. The optional Diagenode Water Cooler circulation bath (Cat. No. BioAcc-cool) features two pumps (“IN” and “OUT”) and produces a regular water flow to maintain a constant water level in the tank. An additional regulating valve (the “Connectors Kit for Water Cooler”) should be installed into the water circuit (from the refrigerating unit to the Bioruptor) to ensure that the water flows at an optimal level. The water flow must not exceed 500 ml/min to allow optimal resonance. The Water Cooler can be ordered directly through Diagenode with all the required tubing (see price list). The Water Cooler is not available to North American customers.

**Motorized Lid**

The motorized lid, along with the blue gear plate accessory, keeps the sample tubes in constant rotation and ensures optimal position in the waterbath during sonication. When in motion, do not hamper the rotation of the blue gear plate. Avoid the immersion of the motor into the water.

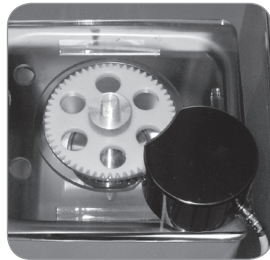

Motorized Lid

**Sound-Proof Box**

A plastic sound-proof box is available for the UCD-200. The metal sound-proof box for the UCD-300, UCD-400, and Bioruptor XL is very efficient in absorbing the noise generated by the ultrasonic waterbath, which is placed inside this box.



Sound-Proof Box

**Tube Holders**

Several sizes of tubes can be used with the Bioruptor. The maximum and minimum sample volume to be used with each container is given in the table below. The 0.5 ml and 1.5 ml tubes can be simply closed and installed in the rotor. For the sonication of larger volumes (10 ml, 15 ml, and 50 ml tubes), a stopper with a metallic bar has to be used to reflect sound waves to produce a better resonance efficiency.

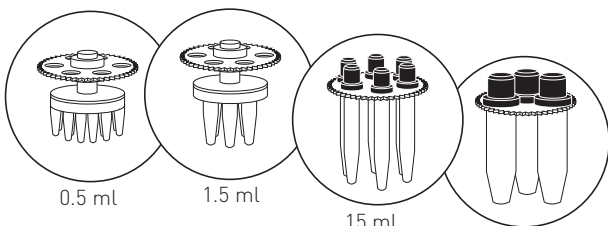

Tube Holders

**Power Supply Adapter**

**A power supply adapter is needed when operating the Bioruptor outside the U.S. with a voltage other than 110V.** This unit provides the instrument with several signals used at the different stages during operation. The power supply adapter is the heaviest part of the apparatus and needs particular handling caution.

The power supply adapter for the UCD-300, UCD-400 and Bioruptor XL is switched on with the power button located on the back. The UCD-200 does not need to be switched on.



Power Supply Adapter



# Equipment Installation

The following pages contain information on installing your particular Bioruptor model. In the interest of safety, this equipment must only be installed by competent personnel after reading this section. Consider all hazards even though no particular hazards have been identified during installation. Before starting installation work, turn the main switch off (beyond power connection) and secure the unit against being re-energized. No special tools are required. Three (3) square meters are needed to set-up the Bioruptor.

## Devices are designed to be safe under the following conditions:

- Indoor use
- Altitude up to 2, 000 meters
- Operating external temperature 0°C to 25°C
- Maximum relative humidity 80%
- Transient overvoltage typically present on the MAINS supply
- Degree of protection: IP20
- Power plug must be grounded
- POLLUTION DEGREE 2 (Normally only non-conductive pollution occurs. However, occasionally a temporary conductivity caused by condensation is expected.)
- Never install this equipment in a place where environmental conditions and warnings mentioned above are infringed.

## Power Supply Adapter

The power supply adapter must be plugged into the power grid. An IEC lead is provided.

**IMPORTANT WARNING: Ensure that your power inlet (behind the power supply adapter) shows the right voltage corresponding to your area. Otherwise, switch it using a narrow blade screwdriver.**

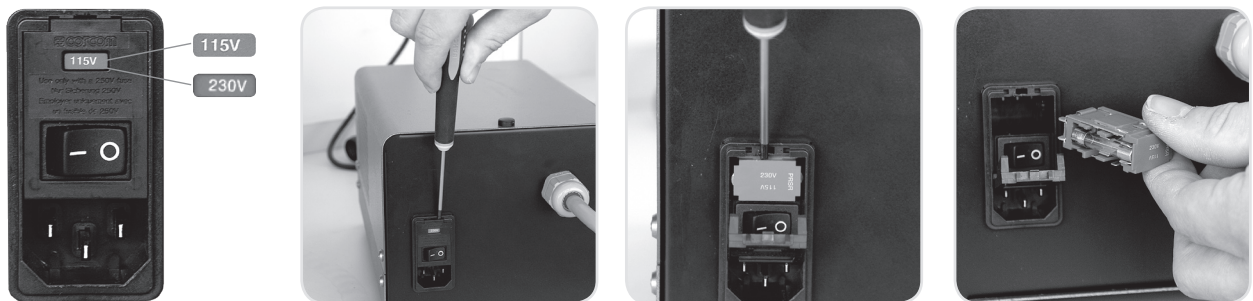

## Attaching Cables

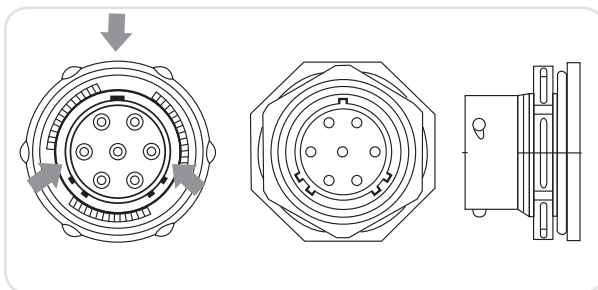

When connecting cables, always be sure pins are properly aligned. Note the indexing pins on the control unit cables for precise mating alignment.



Keep dot facing up.



Once plugged in, secure by turning 90° clockwise until a click is heard.



## Installing the Bioruptor UCD-200

**Note:** Control unit connector has two different plugs; one is for the control unit and the other is for the waterbath. Turn the connector 90° to secure the connection.



**1. Connect the power supply adapter to the control unit with the power cable.**

(Power supply adapter is only needed outside the U.S.)



**2. Connect the waterbath and control unit using the control unit cable.**

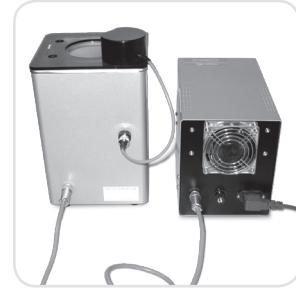

**3. Connect the rotor. Rotate the black cap to secure the connection.**



**4. Place the waterbath into the sound-proof box and add the accessory.**



**You are ready to work.**

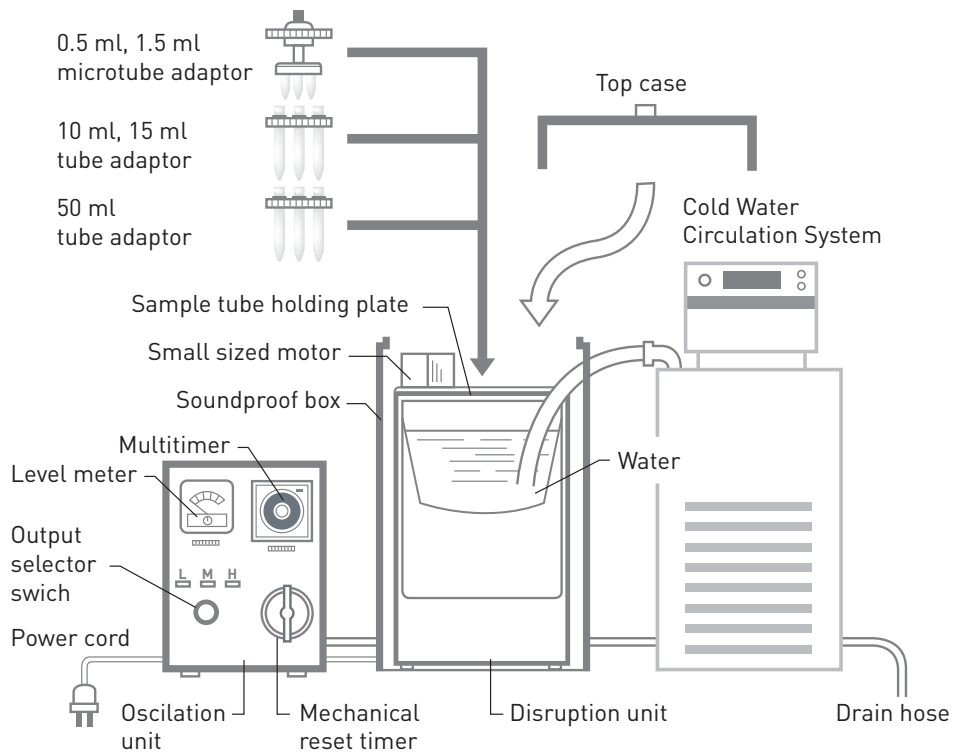

## Installing the Bioruptor UCD-300 and UCD-400

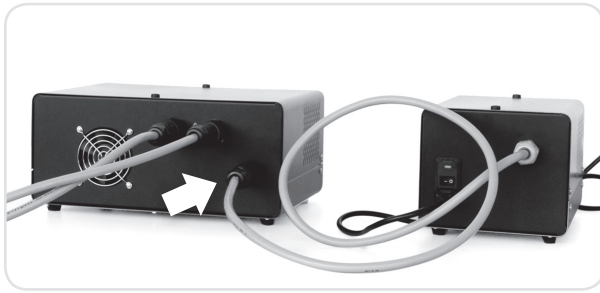

1. Connect the power supply adapter to the control unit with the power cable.  
(Power supply adapter is only needed outside the U.S.)

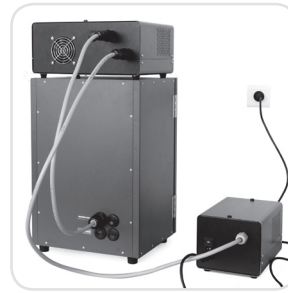

2. Connect the controller to the waterbath through the sound-proof box.



3. Remove the rubber cap from the back of the sound-proof box and feed the instrument cable through the upper left hole marked instrument cable.



4. The fitting will secure the cable to the sound-proof box. Turn the front section counterclockwise to seal. Be sure there is enough slack in the cable.



5. Connect the instrument cable to the waterbath and place into the sound-proof box.

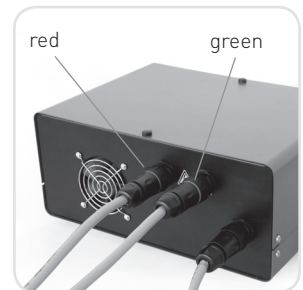

NOTE: The UCD-400 has dedicated connectors that are colored red and green with corresponding receptacles.

### Bioruptor UCD-300



### Bioruptor UCD-400 Twin



### Bioruptor UCD-300

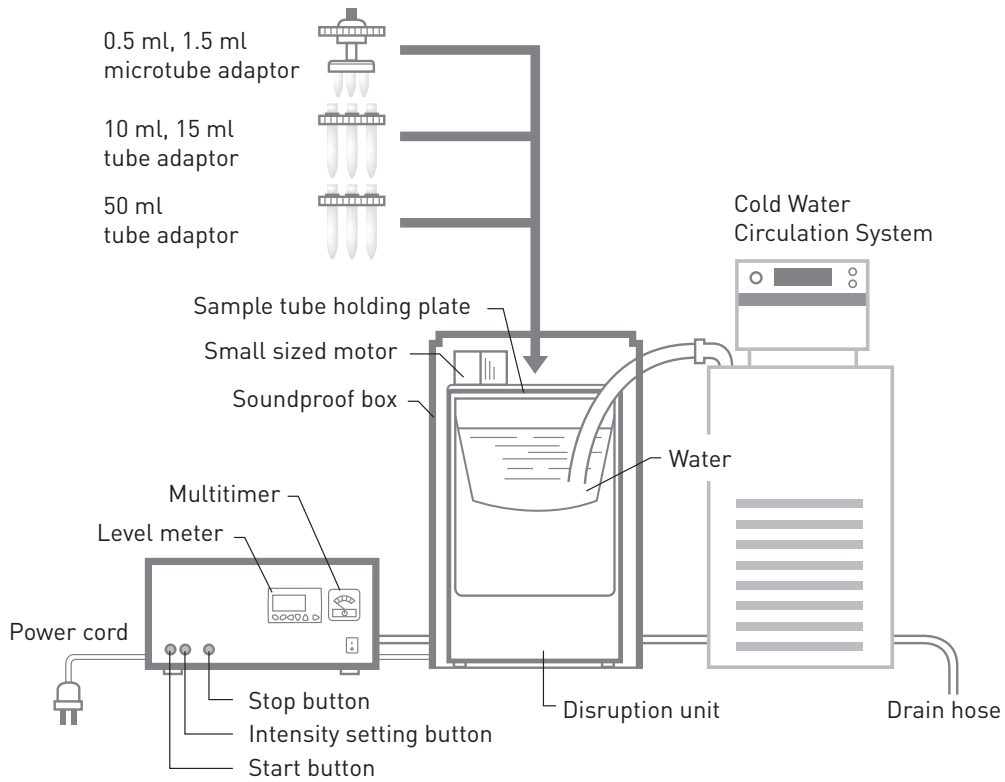

### Bioruptor UCD-400 Twin

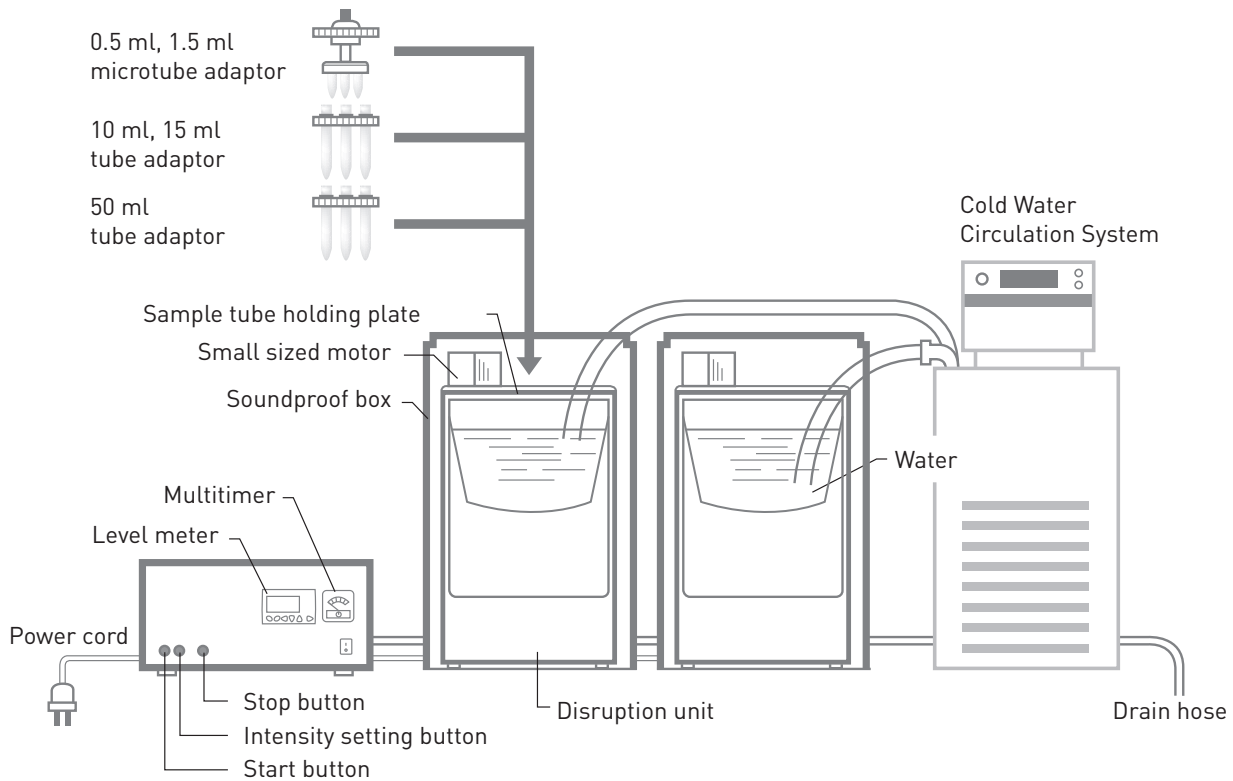

## Installing the Bioruptor XL

**Note:** Control unit connector has two different plugs; one is for the control unit and the other is for the waterbath. Turn the connector 90° to secure the connection.



**1. Connect the power supply adapter to the control unit with the power cable.**  
(Power Supply Adapter is only needed outside the U.S.)

**2. Connect the waterbath and rotor.**  
Rotate the black cap to secure the connection.



**3. Add the accessory and place the waterbath into the sound-proof box.**

**4. Connect the waterbath and control unit.**

**You are ready to work.**

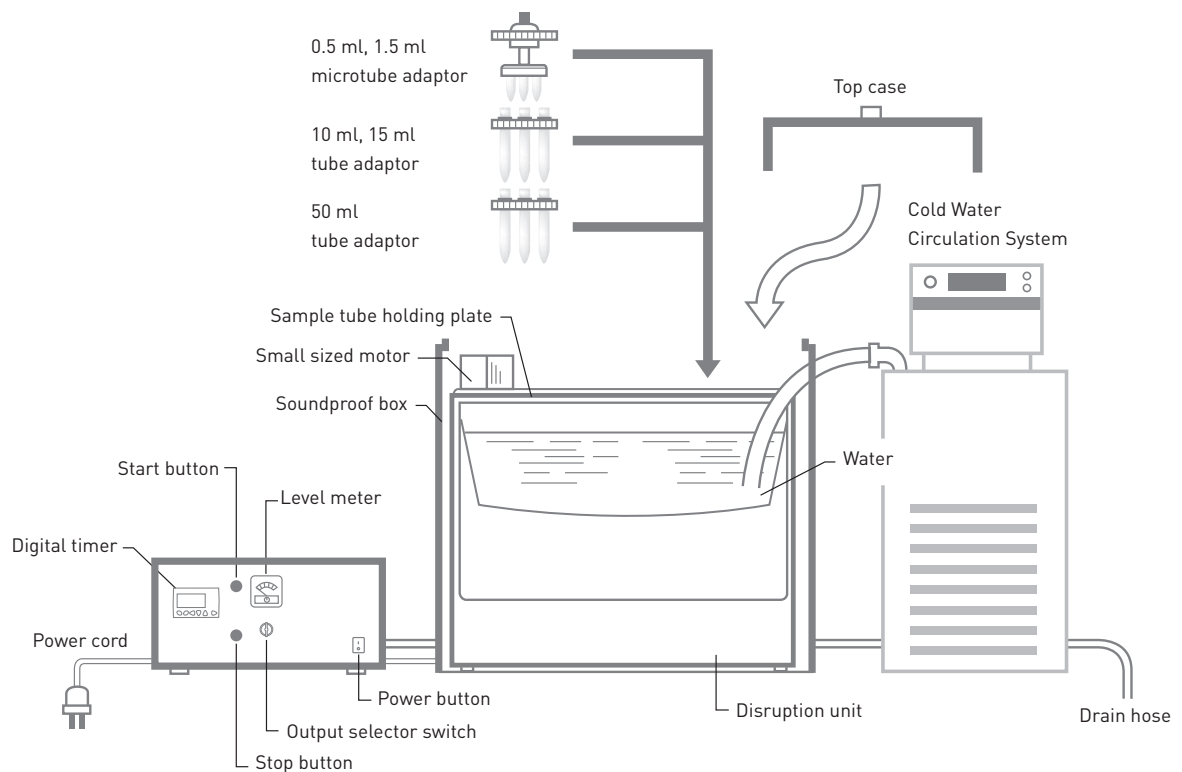

# Control Units

## Bioruptor UCD-200

**Multi-timer:** Produces automatic “ON” and “OFF” cycles to preserve samples from overheating from ultrasound energy. The green needle shows the “OFF” time and can be set by turning the external surface of the dial. The red needle shows the “ON” time and can be set by turning the internal knob of the dial. The time units (min 0 sec) can be modified by using a screw driver on the screws directly above the “ON” and “OFF”.

**Total (analog) timer:** The Bioruptor is activated by the clockwise rotation of this dial. The maximum time is 15 minutes. The time set will equal the sum of the “ON” and “OFF” cycles. Alternatively, turning the timer knob counterclockwise will set the Bioruptor on a permanent position (always cycles “ON” and “OFF”). To stop this process, manually set the timer knob on to the vertical position.

**Intensity setting dial:** 3 power settings are available for the sonication: **L** (Low, 160W), **M** (Medium, 200W) and **H** (High, 320W).

**Intensity level meter:** Allows visualization of sonication intensity.

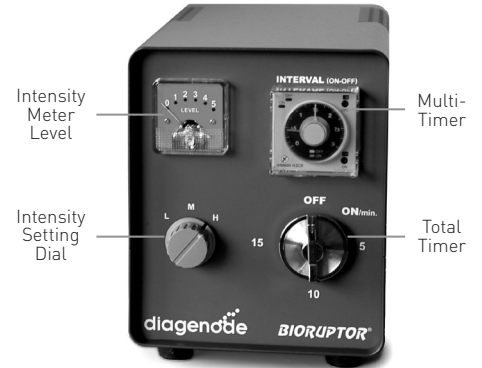

## Bioruptor UCD-300 and UCD-400

### Controlling the Sonication

**CYCLE NUMBER, TIME ON** and **TIME OFF** are the parameters controlling the sonication. First press UP or DOWN depending on the value to be modified. The four flashing black squares move up or down. Once the selected values are chosen to be modified, press OK. The four flashing black squares disappear and 2 digits start flashing. The digits can be changed by pressing UP or DOWN. To select and save the correct number, press OK to confirm or ESC to escape without saving the change.



Once all parameters are selected and confirmed, press **START**.

Once the run is started, “**BIORUPTOR RUNNING**” is displayed on the control screen.

### UCD-300 Digital Timer

After the introductory message, the control screen shows the main sonication parameters in the first three lines (CYCLE Number, Time ON, Time OFF) and summary of actions in the last line (see example below).

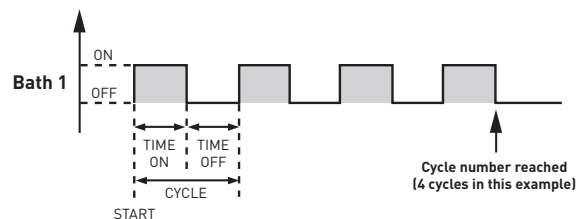
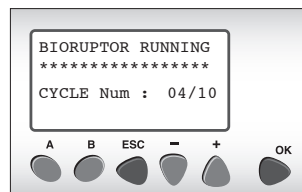
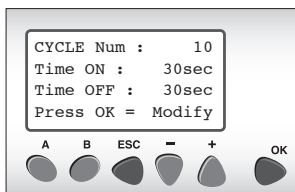

The display shows cycle 4 of 10.

Waterbath will sonicate as shown.

## Digital Timer (UCD-400)

After the introductory message, the control screen shows the main sonication parameters in the first two lines (**CYCLE Number, Time**) and summary of actions in the last line (see example below).

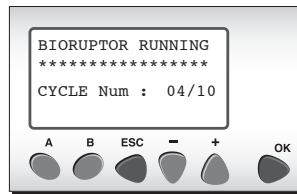
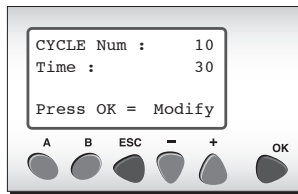

The display shows cycle 4 of 10.

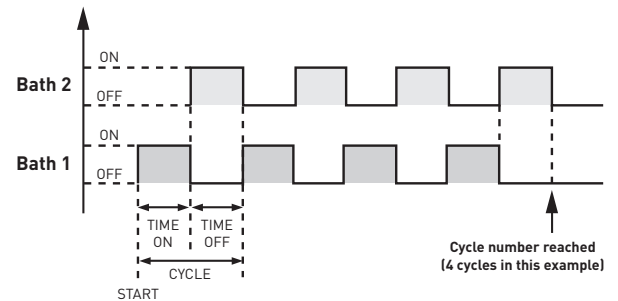

Waterbath will sonicate as shown.

## Overheat Shutdown for UCD-300 and UCD-400

The ultrasound source is sensitive to high temperatures which means that increases in temperature diminish the sonication efficiency and can damage the device. The production of ultrasound generates heat which is transferred into the waterbath. To avoid excessive overheating of the ultrasound source, the Bioruptor Plus (UCD-300) and Twin (UCD-400) contains a temperature sensor. We recommend that the water in the waterbath remain between 4°C–10°C (39°F–50°F) for optimum sonication.

**Note:** The sensor does not measure the water temperature inside the ultrasound bath where the samples are submerged. Once a critical limit is reached a warning is displayed on the control screen. Depending on the situation, different screens pop up as described below:

1. If **START** is pressed and the instrument stops after a couple of seconds showing the following screen blinking, the instrument could not start a new run due to the ultrasound source's temperature.

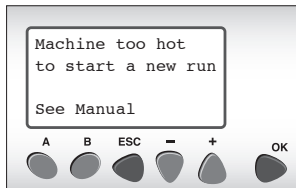

### Causes:

- Instrument has been used several times in a row recently without breaks
- Instrument is stored in a place exposed to direct sun
- Room temperature is too hot

### What to do:

- Store the instrument in another place if the current one does not meet the installation specific requirements
- Allow for longer breaks between uses
- Place crushed ice in waterbath to help the cool ultrasound source

2. During a run, if the instrument stops and the following screen pops up, the critical temperature has been reached. To protect the ultrasound source from damage, the instrument has stopped and is standing by to be restarted after the ultrasound source has cooled.

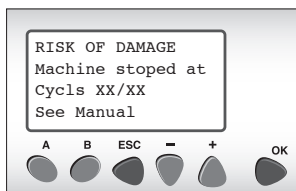

### Causes:

- Instrument has been running too long without breaks

### What to do:

- Store the instrument in another place if the current one does not meet the installation specific requirements
- Allow for longer breaks between uses
- Place crushed ice in waterbath to help the cool ultrasound source

3. If the warning message appears at the bottom of the BIORUPTOR RUNNING screen (see below), it means that the critical temperature is about to be reached.

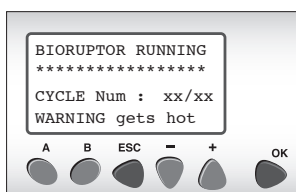

### Causes:

- Instrument has been running too long without breaks

### What to do:

- Reduce the number of consecutive cycles or split protocols into two runs separated by a break
- Keep cold water in the sonication bath while running to help keep the ultrasound source at low temperature



# Bioruptor XL



## Controlling the Sonication

First switch on the Bioruptor with the POWER button. Next set the intensity level ( L=130W, M1=200W, M2=250W, and H1=300W). Next, use the digital timer as described in the following steps: note, the parameters **CYCLE NUMBER**, **TIME ON** and **TIME OFF** control the sonication.

1. If START is pressed and the instrument stops after a couple of seconds showing the following screen blinking, the instrument could not start a new run due to the ultrasound source's temperature.

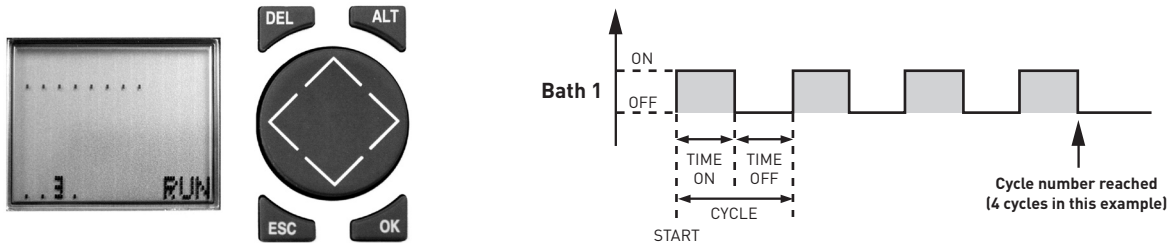

2. To enter Time Settings, go down to PARAMETER and Press OK. Please disregard the manufacturer settings (Password, Stop Run, Info)

**Attention! Do not change the password!**

3. After you get into PARAMETER, select T1. Select I1, go left and go up and down to choose the total sonication time (in minutes and seconds). And then push OK. Do not change the I2. I2 must be +0.



## 4. ON and OFF Cycles

The control unit allows the automatic production of "ON" & "OFF" cycles to preserve the samples from rapid heating due to ultrasonic waves. ON cycle Select T2. Repeat as for T1.



# Using Adaptors & Holding Plates

## Adaptor Tube Units—Available in 0.5 ml, 1.5 ml, 10 ml, 15 ml, and 50 ml

To use adaptor tube unit, remove the lower part of the microtube holder by turning counterclockwise. Then place microtubes in the unit. Attach the lower part to the upper part of the adaptor. To guarantee homogeneity of chromatin shearing, the tube holders should always be completely filled with tubes. To ensure reproducibility, always use the same brand of tubes.

- The 2 ml polypropylene tubes (thin-walled) should not be used with the Bioruptor. 1.5 ml tubes in TPX plastic that provide better ultrasound transfer rates and more efficient sonication are available from Diagenode (see price list). These tubes should be used for chromatin shearing, not DNA shearing.
- Any 0.5 ml or 1.5ml tube can be used although shearing efficiency is increased by using the hard plastic tubes (TPX hard plastic) available from Diagenode. See catalog numbers on price list.
- The complete adaptor (including O-ring) can be sterilized in the autoclave. After more than 20 autoclave sterilizations, the O-ring might need to be replaced (see price list for spare parts).



**0.5 ml tube adaptor unit**  
(Cat. No. UCD-pack 0.5)

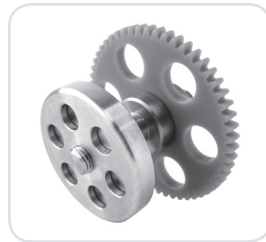

**1.5 ml tube adaptor unit**  
(Cat. No. UCD-pack 1.5)



**10 ml tube adaptor unit**  
(Cat. No. UCD-pack 10)



### **15 ml tube adaptor unit (Cat. No. UCD-pack 15)**

The adaptors for 15 ml tubes are available in blue (Falcon tubes) and orange (Corning tubes). If you use another brand of tubes, use the one which fits in the holder the best. When using the 15 ml tubes, do not forget to insert the aluminium ring to ensure an optimal position of the tube during sonication.



### **50 ml tube adaptor unit (Cat. No. UCD-pack 50)**

Three different models of adaptors for 50 ml tubes are available—one for Nalgene and two for Falcon.

**Nalgene:** These tubes offer the best efficiency in terms of transfer of the ultrasound energy and can be ordered directly from Diagenode (Cat. No. 3015-0050).

**Falcon or Corning:** The adaptors for 50 ml tubes are available in blue (Falcon tubes) and orange (Corning tubes). If you use another brand of tubes, use the one which fits in the holder the best.

**Note:** The quality of the 50 ml Corning tube: “hard” plastic (polyethylene-ref Corning 430304) can be used as well as “soft” plastic (Polypropylene, ref. Corning 430290 ) but you should stick to one kind as transfer of ultrasonic waves is different for the different tube types (hard plastic is more efficient). For Falcon tubes, only polypropylene tubes are available.

## Holding Plates

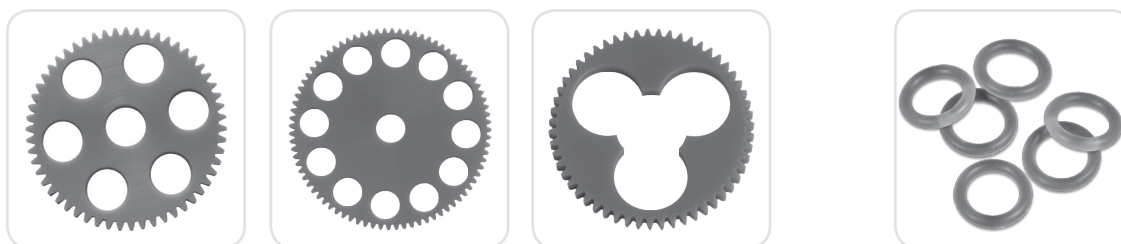

### Gear Plates (included with tube adaptor kits)

The gear plates (holding plates) for 10 ml and 15 ml tubes can accommodate up to 6 tubes for the UCD-200, UCD-300, AND UCD-400 and up to 12 tubes for the Bioruptor XL. For 50 ml tubes, the sample holding plate is the NG-50-3 which can accommodate up to 3 tubes. The holding plates should always be completely filled to guarantee homogeneity of shearing.

### O rings (for 10ml, 15ml, 50ml tube adaptor units)

Removing the black knob, it is possible to replace the O-ring. The complete resonance chip (including O-ring) can be sterilized in the autoclave. After more than 20 autoclave sterilizations the O-ring might need to be replaced (see price list for spare parts).

# Sonication Protocols

## Sample Protocol for DNA Shearing (Next Generation Sequencing Applications)

The following describes our in-house protocol for DNA shearing for sequencing library preparation.

### Samples

Prior to sonication, human DNA samples were dissolved in a sonication buffer of TE (10 mM Tris, 1mM EDTA), pH 8 with a DNA concentration of 0.01 µg/µl and a final volume of 100 µl.

Costar 0.65 ml Low Binding Microcentrifuge Tube (Cat. No. COR-3206) and Tube holder for 12 x 0.5 ml tubes (Diagenode, Cat. No. UCD-pack 0.5). All samples were vortexed and centrifuged before shearing in the Bioruptor sonication system.

	Roche Genome Sequencer-FLX	Illumina Genome Analyzer	Life Technologies SOLiD™
<b>Required fragment size post sonication</b>	100–800 bp	100–500 bp	100–300 bp
<b>Small genomes</b> (e.g. Bacterial)	5–10 cycles	20–30 cycles	60–80 cycles
<b>Large genomes</b> (e.g. Human)	5–10 cycles	30–40 cycles	80–100 cycles

### Sonication Parameters

As shown in the table, sequencing libraries were prepared by sonicating genomic DNA to obtain optimal fragment size distributions to fit those recommended by the manufacturers of each of the commercial sequencing platforms (Solexa, SOLiD and 454 platforms). We established a set of sonication conditions that could be used to generate each of the required size distributions, by varying only the duration of sonication (ie, the number of cycles), and leaving the buffer concentrations, power, and other parameters identical between runs.

#### These conditions were:

- Low power, 1 min sonication cycles (30 sec "ON", 30 sec "OFF"), and number of cycles based on desired DNA size. The temperature was kept at 4°C (using the Diagenode Water cooler, Cat. No. BioAcc-Cool) for optimal shearing results.
- For the larger fragments (1.5 kb and higher), the Bioruptor was set on 50% of the Low power setting and samples were kept at room temperature.

## Bioruptor Sample Protocols: Chromatin Shearing for ChIP Assays from Eukaryotic cells (adherent or suspension cell lines) with ionic detergent buffers

### Low Eukaryotic Cell Number: Protocol to obtain 300-500 bp chromatin fragments

#### 1. Starting material

- 100,000 to 1,000,000 fixed cells
- Use preferably 1.5 ml TPX tubes (Cat. No. M-50050) or 0.5 ml tube but can be optimized with all kind of tubes.
- Shearing Buffer B from the Diagenode's ChIP kits (for the complete list of ChIP kits containing Buffer B, please refer to the list provided at the end of this protocol). As an alternative, the reagents and protocols provided with the Shearing Optimization kit (ref. kch-shchro-040) or with the Shearing ChIP kit (kch-redmod-100 / kch-redmod-400) can also be used.

#### 2. Sonication parameters

- Set Bioruptor on "High" Power setting (H).
- Add 130 µl of complete Buffer B (RT) to the cells. Vortex until resuspension. Incubate for 5 minutes on ice.
  - Use preferably the cooling system but if not; fill the tank with cold water (4°C) and supplement with 0.5 cm crushed ice.
  - Submit the samples to sonication to shear the chromatin using the Bioruptor for 12 cycles of: [30 seconds "ON", 30 seconds "OFF"] each.
- Reverse cross-links and analyze on gel.

#### 3. Notes

- Protocol for quick analysis of shearing is given in the "additional protocol" section of the kit manual.

### High Eukaryotic Cell Number: Protocol to obtain 300-500 bp chromatin fragments

#### 1. Starting material

- Nucleus from 1,000,000 to 10,000,000 fixed cells
- Use preferably 1.5 ml TPX tubes (Cat. No. M-50050) but can be optimized with all kind of tubes.
- Shearing Buffer B from the Diagenode's ChIP kits (for the complete list of ChIP kits containing Buffer B, please refer to the list provided at the end of this protocol). As an alternative, the reagents and protocols provided with the Shearing Optimization kit (ref. kch-shchro-040) or with the Shearing ChIP kit (kch-redmod-100/kch-redmod-400) can also be used.

#### 2. Sonication parameters

- Set Bioruptor on "High" Power setting (H).
- Add 200 µl of complete Shearing Buffer S1 (RT) to the cells. Vortex until resuspension. Incubate for 10 minutes on ice.
  - Use preferably the cooling system but if not; fill the tank with cold water (4°C) and supplement with 0.5 cm crushed ice.
  - Submit the samples to sonication to shear the chromatin using the Bioruptor for two run of 10 cycles: [30 seconds "ON", 30 seconds "OFF"] each.
  - Spin and vortex between each run
- Reverse cross-links and analyze on gel.

#### 3. Notes

This protocol is a starting point and the total time of sonication and/or "ON"/"OFF" cycling parameters should be modified. The susceptibility of each chromatin can vary depending on the cell type or cell number. So we suggest conducting a time course (e.g. 10-15 cycles of [30 seconds "ON", 30 seconds "OFF"]) for Low cell number) to determine optimal shearing time for your cell line or cell mass.

---

#### ChIP kit references including Buffer B:

- AUTO ChIP KIT (AB-Auto01-0016; AB-Auto01-0100)
- LowCell# ChIP Kit™ (kch-maglow-A16; kch-maglow-G16; kch-maglow-A48; kch-maglow-G48)
- HighCell# ChIP kit (kch-mahigh-A16 ; kch-mahigh-G16)
- Transcription Factor ChIP kit (old description: Red ChIP kit) (kch-redTBP-012)
- Histone ChIP Kit (old description: Orange ChIP kit) (kch-orgHIS-012)
- OneDay ChIP Kit (kch-oneDIP-060; kch-oneDIP-180)

# Optimal Sonication Parameters

The Bioruptor brings flexibility and walk-away parallel processing to sonication. Different sonication parameters and protocols can be customized to your specific application, sample type, volume, and desired size range. Before starting a new application or using a new tissue sample type, it is a good idea to carry out one or more preliminary test runs in order to empirically optimize the best instrument parameters for your particular research goals. Consider varying the type of sample, sample concentration, volume, instrument power, and duration of sonication, in order to identify the best parameters for your experiments. Once run conditions are optimized, the Bioruptor provides unparalleled reproducibility from sample to sample and run to run.

## Critical Points

Use these starting points as the sonication parameters to yield the best results for a number of applications.

- **Water level in the tank:** Fill precisely to the blue line
- **Temperature:** Use the Diagenode Water Cooler (Cat. No. BioAcc-cool) for automated temperature control
- **Power:** For chromatin shearing set the output selector switch on High (H). For DNA shearing, (e.g. Next Gen Sequencing applications) set the output selector on Low(L) for small to medium size fragments (100 to 800bp) or on Extra Low (HL) for large size fragments (1000 to 5000bp)\*
- **Cycling parameters:** 30 seconds "ON" & 30 seconds "OFF"
- **Tube adaptors and holders:** See "Using Adaptors and Holding Plates" on page 16 for optimal tube recommendations. Make sure holding plates are completely full for best results.
- **Tube preparation:** All samples should be vortexed and centrifuged briefly (e.g. 10-20 seconds) before shearing in the Bioruptor sonication system.

## Optimization Test (Chromatin Shearing)

Optimization is required to obtain reproducible sonication results. Various factors influence the outcome such as:

- **Complexity of the mixture.** Cell lysis extracts, DNA solutions, or liposome suspensions are complex mixtures of molecules. The ability to disrupt biological materials by sonication depends on the individual molecule concentration and on the presence of contaminants.
- **The viscosity of the solution** is another factor that can affect the sonication efficiency, as the cavitation process is dependent on the viscosity coefficient of the solution.
- **The fixation step** (percentage of formaldehyde, duration, and temperature) for ChIP assay users is a key factor that can affect the chromatin shearing efficiency.

The best way to start optimization tests with the Bioruptor is to collect a large quantity of the biological material to be sonicated. This material should be well-characterized, easily attainable, and available in sufficient quantities for repeat optimization tests. For example, a nuclear extract should be always produced with the same protocol and generated with a fixed number of cells. Since the sample concentration is a key factor to calibrate sonication efficiency, a serial dilution should be performed with the starting material. For example 6 aliquots of the starting material could be diluted as follows: 1X, 5X, 10X, 20X, 50X and 100X.

Sonicate the 6 tubes together using the sonication parameters of 30 seconds "ON" & 30 seconds "OFF." If insufficient disruption occurs, either perform a further serial dilution of the samples or increase the total time of sonication. If excessive disruption occurs, either concentrate samples or reduce the total time of sonication. A fine tuning of the "ON" & "OFF" cycles and of the other sonication parameters can be done once a satisfactory result has been obtained on a specific sample concentration.

The optimal conditions should give excellent sonication reproducibility (i.e. fragment size) and preservation of the sonicated material without overheating.

**The aliquot volume in each tube should be fixed and correspond to the chosen tube.**

Tube Size	Maximum volume	Minimum volume
0.5 ml	100 µl	10 µl
1.5 ml	300 µl	100 µl
15 ml	2 ml	500 µl
50 ml	20 ml	3 ml
50 ml	8 ml	1 ml

**Important note when testing different sonication vessels:**

15 ml and 50 ml tubes are sonicated in the Bioruptor with a metal bar which triggers the resonance effect and improves the sonication efficiency. In other words, if you optimized your sonication parameters in 15 ml tubes, the same sample concentration will not necessary be applicable to sonication in tubes. Greater sample dilutions for the tubes should thus be tested.

**Bioruptor: Chromatin Shearing Example**

U2OS cells are fixed with 1% formaldehyde (10 minutes at RT). One million cells are resuspended per 30  $\mu$ l of lysis buffer prior to chromatin shearing. Each sample consists on 5x 10<sup>6</sup> cells per 1.5 ml tube. Samples are sonicated for 15 cycles of: [30 seconds "ON" / 30 seconds "OFF"] with the Bioruptor from Diagenode (Cat. No. UCD-200). Samples 1 and 2 are duplicates. The sheared chromatin is submitted to a cross-linking reversion, DNA purification and RNase treatment. Then the samples are analyzed on a 1% agarose gel. Two amounts of sheared chromatin are analyzed (1.5  $\mu$ l and 3  $\mu$ l). The 100 bp DNA molecular weight marker is on lanes 1 and 4.

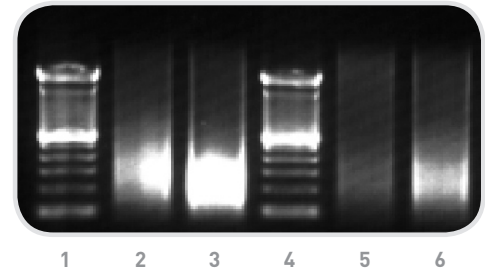
**Analysis on an agarose gel of the sheared chromatin****Quick Overview: Tips for Starting a Successful Sonication**

Critical Steps	Solutions	Comments
Water level in the tank	Water level up to the blue line	- Do not add too much water or too little - Never start the sonication without water in the tank
Water temperature in the tank	Keep cool	It is best to pre-cool the tank before starting the first round of sonication in order to reduce the water heating due to thermal inertia if the tank is stored at room temperature. Use the automated cooling system as described on page 7. Alternatively, manual temperature control protocols may also be used.
Minimum sample volume per tube for each sonication trial	10 $\mu$ l	In 0.5 ml tubes
	100 $\mu$ l	In 1.5 ml tubes
	500 $\mu$ l	In 15 ml tubes
	3 ml	In 50 ml
	1 ml	In 50 ml
Maximum sample volume per tube for each sonication trial	100 $\mu$ l	In 0.5 ml tubes
	300 $\mu$ l	In 1.5 ml tubes
	2 ml	In 15 ml tubes
	20 ml	In 50 ml
	8 ml	In 50 ml
Quality of the 15 ml tube	Falcon or Corning	Polystyrene or polyethylene (clear tube in "hard" plastic) is much more efficient for the transfer of ultrasonic waves for chromatin shearing. Do not use TPX tubes for DNA shearing as prolonged shearing times may damage the DNA.
Sonication in 15 ml tubes	Do not forget to insert the aluminum ring	The ring is essential to ensure an optimal position of the tube during sonication
Sonication process	Sonicate by cycles	Cycles of 30 seconds "ON" & 30 seconds "OFF" are advised for chromatin shearing and DNA shearing
Optimization of sonication cycling time	Cycles dependent on the sample volumes and type of tubes	Cycles depend on the application (chromatin shearing, DNA shearing, RNA shearing, obtention of bacteria lysates or tissue lysates)

For 0.5 and 1.5 ml tubes, we have optimized with Sarstedt, Costar, Eppendorf, Fisher Bioblock Scientific, and Diagenode tubes.

# Troubleshooting

## Bioruptor: Chromatin Shearing FAQs

Critical Steps	Questions	Answers	Comments
<b>Fixation</b>	What is the formaldehyde final concentration?	1%	Correct formaldehyde concentration in fixation is critical.
	How long is the fixation step?	Fix for 10 minutes (with a time course when needed)	It is possible to fix for as little as 5 minutes (depending on your protein of interest for subsequent ChIP assays).
	What is the temperature to use for fixation?	Fix at room temperature	Fixation can be performed at 4°C, RT, and 37°C. Make sure you perform the fixation step at the right temperature.
	Are the washes after fixation important?	Wash the fixed cells properly. Make sure you get rid of ALL the formaldehyde. Use glycine to stop the fixation.	
<b>Cell lysis</b>	How can I achieve complete cell disruption?	Do not use too many cells in the cell lysis buffer. Lyse about 5x 10 <sup>6</sup> cells/1 ml	The HighCell # ChIP kit is compatible with cell numbers up to 10 million cells in small volumes.
<b>Number of cells/ shearing buffer volume</b>	What is the amount of cells per shearing trial to use?	1x 10 <sup>6</sup> –10x 10 <sup>6</sup> cells/ 300 µl 3x 10 <sup>6</sup> –30x 10 <sup>6</sup> cells/ 1 ml	Do not use a too high cell concentration.
<b>Shearing buffer</b>	What is the key buffer component?	Include detergent in buffer	Quality and quantity of detergent is important.
<b>Shearing step</b>	How long is the shearing?	Perform a time course for chromatin shearing	It is possible to shear from 5-30 minutes. If 30', interrupt sonication after 15 minutes and centrifuge tubes briefly before proceeding with the remaining 15'.
	What is the optimal cycle?	30 seconds "ON" + 30 seconds "OFF"	
	What is the best temperature for shearing?	4°C	Make sure waterbath is kept cool. Once optimal conditions are reached, use for all assays to assure reproducibility.
	What is the best volume/ tube for shearing?	1.5 ml per 15 ml tube 200 µl per 1.5 ml tube	Do not use a too big sample volume
<b>Checking for high-quality shearing on an agarose gel</b>	What kind of gel should I use to determine size accuracy?	Check disrupted material on a 1% agarose gel (10 µl/lane). Run the gel slowly	Reverse cross-links from DNA after phenol/chloroform extraction before loading on gel.
	What do smears indicate?	Gel electrophoresis of cross-linked samples often gives smears on gel. Also take several pictures of the gel to assure image quality.	To obtain clearer image with accurate fragment size, reversion of the crosslinking is advised.
	How much DNA should I load and is RNase treatment necessary?	The migration of large quantities of DNA on agarose gel can lead to poor quality pictures which do not reflect the real DNA fragmentation.	Do not load too much on a gel. Do not load more than 5 µg/lane. Also treat the sample with RNase.
	What should my running buffer concentration be?	1X TAE or TBE is preferred to 0.5X TAE which can lead to smears on gel.	
	Will using an old gel cause problems?	Use a freshly prepared gel and fresh buffer.	Do not reuse an old gel.

# Bioruptor Packing Instructions

If you need to ship your Bioruptor for any reason, it is important to follow these specific packing instructions as the Bioruptor is extremely fragile. Please use our pre-molded container and components for packing.

The box is composed of a double wall corrugated carton, a foam base, and a foam lid made of ultra shock-absorbent foam. Each part of Bioruptor has a designated area in the box (as shown).



## 1. Tank unit preparation

- A)** Place a scrap piece of corrugated cardboard over the top of the tank (as shown).
- B)** Tie packaging strap around the tank and cardboard.
- C)** Tighten the strap as securely as possible (due to extreme fragility of tank unit which is prone to damage during transit).

## 2. Placement of components

- A)** The controller unit should be placed in the largest rectangular recessed area in the molded foam box with the fan toward the outer side of the box.
- B)** The tank unit should be placed in the square recessed area in the molded foam box towards the inside of the box (as shown). Wedge a piece of cardboard in the space between the housing and the foam to keep the tank in place.
- C)** The motor plate should be placed in the slotted area in the molded foam with the motor towards the inside of the box (as shown). Tuck the cable into the foam in the middle of the circle of the motor plate to block its movement.
- D)** Roll the grey cable up and place it in the circular recessed area in the molded foam box. Place the other accessories in the same circular area.
- E)** For UCD-200: The transformer (220V-100V) unit should be placed in the remaining rectangular recessed area in the molded foam box with the cable between the foam and housing. Note: The transformer is not used in every area of the world.

## 3. Placement of foam lid and seal box

- A)** For UCD-200: Place foam lid on the top so that the protrusion in the lid is over the transformer's area. (The protrusion helps to keep things in place during transit.)
- B)** The carton box should be easy to close; otherwise you might have to shift the Bioruptor parts and wires slightly.
- C)** Close the box and seal securely with wide tape.

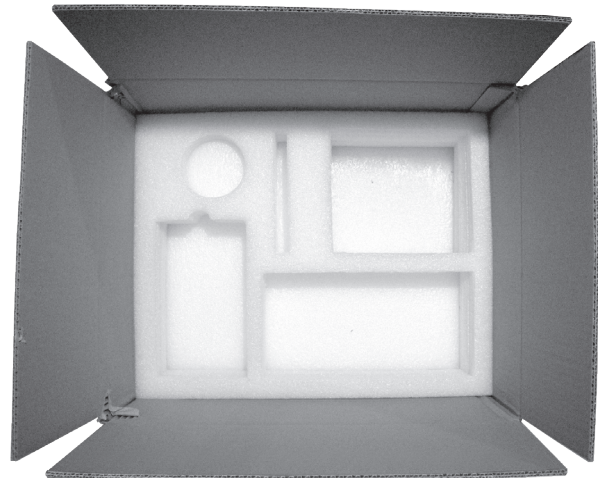



# Related Products

Diagenode offers a number of kits for chromatin immunoprecipitation and methylated DNA immunoprecipitation as shown below. The Bioruptor, with its powerful yet gentle ultrasound technology, allows for consistent shearing, a narrow size range of sheared DNA, and sample preservation, necessary for successful ChIP and DNA methylation experiments.

## Antibodies

Diagenode offers a large selection of optimized ChIP-grade, MeDIP-grade, ChIP-seq grade, and MeDIP-seq grade antibodies that we have developed and characterized in-house. See our price list for more details.

## ChIP Kits—Suitable for ChIP-seq and ChIP-on-chip

	LowCell # ChIP Kit*	HighCell # ChIP Kit*	OneDay ChIP Kit	Transcription ChIP Kit	Histone ChIP Kit	Automated ChIP Kit
Features	Low cell numbers, improved handling (magnetic beads), fast, increased DNA yield	Standard cell numbers, improved handling (magnetic beads), fast, increased DNA yield	Ready-to-use on large quantities of sheared chromatin, fast	Standard protocol (3 days) optimized for transcription factors	Standard protocol (3 days) optimized for Histones and their modifications	Use from 1.000–5 million cells per IP, validated on SX-8G IP-Star Automated System which ensures maximum reproducibility and time savings
Optimized for	All DNA-protein interaction	All DNA-protein interaction	All DNA-protein interaction	Transcription factors and co-factors studies	Histones & modified histones	All DNA-protein interaction
Amount of cells/IP	10e3–10e5	10e6–10e7	1.5–2 X 10e6	10e6	10e5	1.000–5 million
Time from cell collection to PCR	1 day	1 day	1 day	3 days	3 days	1 day
Buffers & Reagents	Cell fixation, collection, lysis / IP / DNA purification	Cell fixation, collection, lysis / IP / DNA purification	IP / DNA purification	Cell fixation, collection, lysis / Shearing / IP / DNA purification	Cell fixation, collection, lysis / Shearing / IP / DNA purification	IP / DNA purification
Control Antibodies & Control Primers	Included	Included	Included	Included	Included	Included
# IP per kit	16	16 or 48	60 or 180	18	18	16 or 48

\* Validated on SX-8G IP-Star (Automated System for ChIP & MeDIP)

## DNA Methylation Kits

	MagMeDIP kit*	MeDIP kit	MethylEasy Xceed Kit	MethylEasy Kit	MBD
Features	Quality control using internal controls, improved handling (magnetic beads), high specificity (monoclonal 5-mec Ab), fast	Quality control using internal controls, high specificity (monoclonal 5-mec Ab), fast	Gives precise information on methylation status of single cytosines	Gives precise information on methylation status of single cytosines	Fast method for transient and cyclical methylation study
Applications	qPCR, linear amplification and genome-wide analysis (microarray, sequencing)	qPCR, linear amplification and genome-wide analysis (microarray, sequencing)	Sequencing	Sequencing	Linear amplification and genome-wide analysis (microarray, sequencing)
Amount of DNA/rxn	1 µg	1 µg	Min 50 pg	Min 100 pg	5 µg
Total Time of Assay	Manual MeDIP: 3 days Automated MeDIP (Robotic System: IP-Auto): 20h	3 days	90min (without primer design and sequencing)	6h–18h (without primer design and sequencing)	5h (incubation time 1h) or 4 h + overnight incubation
Controls	Methylated and unmethylated BAC clones	Methylated and unmethylated BAC clones	Untreated DNA and bisulphite treated DNA	Untreated DNA and bisulphite treated DNA	GST-protein (optional)
# rxns per kit	16 or 48	10	40	25 or 96	50

\* Validated on SX-8G IP-Star (Automated System for ChIP & MeDIP)

## Ordering information

Description	Reference
<b>Bioruptor Models</b>	
Bioruptor® Standard	UCD-200 TM (1.5 ml) UCD-200 TO (1.5 ml & 15 ml) UCD-200 TS (0.5/0.65 ml)
Bioruptor® Plus	UCD-300 TM (1.5 ml) UCD-300 TO (1.5 ml & 15 ml) UCD-300 TS (0.5/0.65 ml)
Bioruptor® Twin	UCD-400 TM (1.5 ml) UCD-400 TO (1.5 ml & 15 ml)
Bioruptor® XL	XL TM (1.5 ml) XL TO (1.5 ml & 15 ml)
<b>Sample Tube Adaptor Kits</b>	
0.5/0.65 ml tube holder for Bioruptor® Standard, Bioruptor® Plus	UCD-pack 0.5
1.5 ml tube holder for Bioruptor® Standard & Bioruptor® Plus	UCD-pack 1.5
10 ml tube holder for Bioruptor® Standard & Bioruptor® Plus	UCD-pack 10
15 ml tube holder for Bioruptor® Standard & Bioruptor® Plus	UCD-pack 15
50 ml tube holder for Bioruptor® Standard & Bioruptor® Plus	UCD-pack 50
<b>Cooling System</b>	
Bioruptor® Water Cooler - including standard connectors for Bioruptor®	BioAcc-cool
Connectors Kit for Water Cooler	CONN-7D1
Peristaltic Pump (Including Connectors Kit)	TWI-pump
<b>Valve Kits</b>	
Connector kit for Water Cooler (Bioruptor® Plus)	VB-100-0001
Valve Kit for UCD-300	VB-101-000
<b>Tubes</b>	
1.5 ml TPX Tubes	M-50050
1.5 ml TPX Tubes	M-50001
10 ml Tubes	AS-100
10 ml Tubes	AS-500
15 ml TPX Tubes	M-UN-15
50 ml Nalgene Tubes	3105-0050

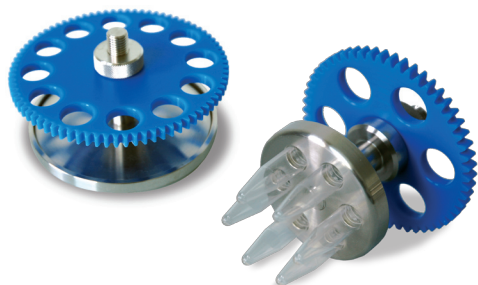

# diagenode

Innovating Epigenetic Solutions

## Diagenode s.a. BELGIUM | EUROPE

Avenue de l'hôpital, 1  
Tour GIGA, 3rd Floor  
4000 Liège, Belgium  
Tel: +32 4 364 20 50  
Fax: +32 4 364 20 51  
orders@diagenode.com  
info@diagenode.com

## Diagenode Inc. USA | NORTH AMERICA

400 Morris Avenue, Suite 101  
Denville, NJ 07834 USA  
Tel: +1 862 209-4680  
Fax: +1 862 209-4681  
orders.na@diagenode.com  
info.na@diagenode.com

For a complete listing of Diagenode's international distributors visit:  
<http://www.diagenode.com/pages/distributors.html>  
For rest of the world, please contact Diagenode s.a.

© 2010 Diagenode, Inc. All rights reserved. The content of this document cannot be reproduced without prior permission of the authors. Bioruptor and IP-Star are registered trademarks of Diagenode, Inc. Bioanalyzer is a registered trademark of Agilent.