

Operation and Maintenance Manual

Electronic Laboratory Autoclaves Models 3840, 3850, 3870 ELV-D

ELV-D: standard autoclave
C: optional system for fast cooling
PV: optional vacuum pump
BH: optional bio hazard filtration
WR: water recycling system
F: optional fan for super-fast cooling



Cat. No. MAN205-0448003EN Rev. J

☒ Heidolph North America , 1241 Jarvis Ave. Elk Grove Village IL, ☎ Phone: 224-265-9600 ☐ Fax: 224-265-9611, e-mail: sales@heidolph.com

☒ Brinkmann Instruments (Canada) Ltd. 4160 Sladeview Crescent #6, Mississauga, Ontario L5N 2L8, ☎ (905) 569-0664, Toll Free: (866) 260-6069, ☐ Fax: (905) 569-0665

Table of Contents

Paragraph Page no.

1.	Generals.....	4
	1.1 Introduction.....	4
	1.2 Available optional configurations	5
	1.3 Incoming Inspection	6
	1.4 Warranty	6
	1.5 Warranty Statement	7
	1.6 Ordering Information	7
	1.7 Accessories.....	8
2.	Safety Instructions	9
3.	Technical Data.....	11
	3.1 Storage Conditions	11
	3.2 Operating Conditions.....	11
	3.3 Directives and Standards	11
	3.4 Environment Emission Information	12
	3.5 Electrical Data	12
	3.6 Water Quality.....	13
	3.7 Specifications.....	15
	3.8 Construction.....	15
	3.9 Utilities.....	16
	3.10 Symbol Description	17
	3.11 Front View (Standard Configuration)	18
	3.12 Front View (WR Configuration, Outside Reservoir)	19
	3.13 Front View (WR Configuration, Inside Reservoir, Only Specific Items Are Shown).....	20
	3.14 Front View (Fan Configuration).....	20
	3.15 Rear View (Standard Configuration)	21
	3.16 Rear View (WR Configuration, Outside Reservoir)	22
	3.17 Rear View (WR Configuration, Inside Reservoir, Only Specific Items Are Shown).....	23
	3.18 Overall Dimensions (3850ELVC-D & WR Configuration, Inside Reservoir), mm).....	24
	3.19 Overall Dimensions (3870ELVC-D, mm)	25
	3.20 Overall Dimensions (3870ELV-PRC-D, mm)	26
	3.21 Overall Dimensions (WR configuration, mm)	27
	3.22 Safety Features	28

4.	Control Panel.....	29
4.1	Control Panel Drawing.....	29
4.2	Description and Functions of the Front Panel Keyboard	30
4.3	Displayed Error Messages / Symbols	32
4.4	Displayed operational messages / Symbols	32
5.	Sterilization Programs	34
5.1	Program 1: Glass	36
5.2	Program 2: Plastic.....	37
5.3	Program 3: Liquid A.....	38
5.4	Program 4: Liquid B – Waste.....	39
5.5	Program 5: Liquid A – Cooling (C – cooling models only)	40
5.6	Program 6: Liquid B – Waste Cooling (C – cooling models only).....	41
5.7	Program 7: Bio Hazard 1 (BH, bio-hazard models only)	43
5.8	Program 8: Bio Hazard 2 (BH, bio-hazard models only)	44
5.9	Program 9: Bio Hazard Liquids (BH, bio-hazard models only).....	45
5.10	Program 10: Vacuum Test (PV, pre-vacuum models only).....	46
5.11	Program 11: Warm-Up	47
5.12	Program 12: Isothermal	48
5.13	Program 13: Air Mixture.....	50
5.14	Program 14: Glass Test	51
5.15	Program 15: Durham.....	52
6.	Checking and Changing Parameters and Other Data	54
6.1	Browsing through the menus.....	54
6.2	Changing a Parameter	55
6.3	Quick options screen.....	57
6.4	Logging in and entering the Main menu	61
6.5	Changing parameters	63
6.6	System Parameters	63
6.7	Maintenance	64
6.8	Cycle parameters	66
7.	Screens	68
7.1	Screens following a complete successfully cycle – "Cycle Ended"	68
7.2	Screens following aborted cycles after complete sterilization stage	68
7.3	Screens following a fail cycle:	69
8.	Printer	71
8.1	Printer Output.....	71
8.2	Printer Handling	74
9.	Preparation before Sterilization	77
9.1	Instruments	77
9.2	Liquids	78

9.3 Loading.....	78
10. Operation.....	80
10.1 Draining and filling the water reservoir (WR only, outside and inside reservoir configurations).....	80
10.2 Turning on the autoclave.....	82
10.3 Opening the door	82
10.4 Loading.....	83
10.5 Closing and locking the door	83
10.6 Starting the cycle	85
10.7 Unloading	86
10.8 Stopping the process and cancelling the ERROR message	86
10.9 Start Cycle by Clock mode	87
10.10	87
Moving the Autoclave	87
10.11	87
Loading and Unloading the Device	87
11. Service and Maintenance.....	89
11.1 Preventive Maintenance	89
11.2 Checking the Safety Valve	90
12. Troubleshooting.....	93
13. Baskets and Containers.....	98
14. Spare Parts List.....	99
15. Accessories	99

1. Generals

1.1 Introduction

A computerized control unit ensuring a fully automatic sterilization cycle controls the autoclave.

The temperature and pressure are controlled through sensors placed inside and outside the media container or bottles.

The sterilizer is fully automatic with a choice of 10 programs, eliminating any need for operator intervention during a cycle program 7 are for vacuum test only). A computerized control unit enables precise control and monitoring of physical parameters and clear documentation of the sterilization cycles.

The autoclave is equipped with a safety valve, which will discharge at an overpressure of over 2.8 Bar (40 psi), which is located on the chamber near the pressure switch and the steam pressure gauge. The control system provides adequate protection, to ensure the safety of personnel and reliable operation with a minimum of down time.

The sterilizer has multiple built - in safety devices, which provides adequate protection to ensure the safety of operating personnel.

On all models, a printer is an optional addition to the autoclave. The printer prints the preset and actual parameters of the cycle (temperature, time and pressure).

The autoclave is provided with a pressure gauge that is used as guide only. Should there be a power failure during the operation of the autoclave, the pressure gauge indicates to the operator that there is pressure in the chamber.

A deviation of +1.6% is accepted.

Note: After operating the sterilizer, brown stains might appear on the bottom of the chamber. These stains are a result of the heating elements that are located at the lower external part of the chamber. The brown color is a common phenomenon, can easily be removed, and will not have any effect on the sterilized goods.

This manual is intended to give the user a general understanding of how the autoclave works and indicates the best ways to operate and

take care of it in order to obtain optimum results and a trouble-free operation. After reading this manual, operating the autoclave should be straightforward. However, since the autoclave is built using high technology sensitive components, no attempt should be made by the user or any other unauthorized person to repair or recalibrate it.



Only technical personnel having proper qualifications, holding technical documentation and adequate test instrumentation are authorized to undertake repair or service.

1.2 Available optional configurations

Models of 3870 ELV model range -D are laboratory sterilizers designed especially for the sterilization of instruments, liquids, and other materials in hospital laboratories, medical laboratories, research institutes, food laboratories and pharmaceutical facilities.

C

A special feature of the ELVC-D models is the fast cooling stage for liquids. In this stage pressure in the chamber is increased by means of compressed air to compensate the fast decreasing of pressure due to the fast cooling. The fast cooling shortens the time required for safe handling of bottles.

Note: there is no cooling option for WR configuration

PV

Special feature of ELVCPV-D models is the vacuum pump that enables air removal prior to sterilization and during the drying stage.

The advantages of the pre-vacuum sterilizer in comparison to the regular gravity displacement steam sterilizer are as follows:

- Removal of air pockets from packs and porous loads and most kinds of tubes (rubber, plastic etc.) by vacuum at the first stage of the cycle.
- Better steam penetration into the load; resulting in effective sterilization.
- Better temperature uniformity.
- Better drying of materials with closed doors due to the vacuum achieved in the chamber at the end of the sterilization cycle.

A special feature of the autoclave is the fast cooling stage for liquids. In this stage pressure in the chamber is increased by means of compressed air to compensate the fast decreasing of pressure due to the fast cooling. The fast cooling shortens the time required for safe handling of bottles

There is a configuration equipped with fan that allows to shorten the cooling operation.

BH

In ELVCPVBH-D (bio-hazard) models, a bio-hazard filter installed in the chamber enables sterilizing bio-hazard load without contaminating the surrounding.

WR

In ELVWR-D (Water recycling) models, water is saved by the water saving system, because it recycles the water and re-uses it for each cycle in the following way:

- Water inlet by the pump from the reservoir and not direct from the plumbing.
- On slow/fast exhaust, the water gets into the reservoir.

Note: Water reservoir may be located inside or outside.

1.3 Incoming Inspection

The autoclave should be unpacked and inspected for mechanical damage upon receipt. Observe packing method and retain packing materials until the unit has been inspected. Mechanical inspection involves checking for signs of physical damage such as: scratched panel surfaces, broken knobs, etc.

If damage is apparent, contact your dealer or point of purchase, so that they may notify the manufacturer and file a claim with the appropriate carrier.

All **Tuttnauer** products are carefully inspected prior to shipment and all reasonable precautions are taken in preparing them for shipment to assure safe arrival at their destination.

1.4 Warranty

We certify that this instrument is guaranteed to be free from defects in material and workmanship for one year against faulty components and assembly with the exception of glassware, lamps and heaters.

The warranty does not include and does not replace routine treatment and preventive maintenance to be performed according to instructions in sec. 12.1 (Preventive Maintenance).

Our obligation is limited to replacing the instrument or parts, after our examination, if within one year after the date of shipment they prove to be defective. This warranty does not apply to any instrument that has been subjected to misuse, neglect, accident or improper installation or application, nor shall it extend to products that have been repaired or altered outside the factory without prior authorization from us.

The Autoclave should not be used in a manner not described in this manual!

1.5 Warranty Statement

To activate your warranty or for warranty information on this unit please contact your dealer or Heidolph at one of the #'s listed below:

☒ Heidolph North America , 1241 Jarvis Ave. Elk Grove Village IL, ☎ Phone: 224-265-9600 ☐ Fax: 224-265-9611, e-mail: sales@heidolph.com

☒ Brinkmann Instruments (Canada) Ltd. 4160 Sladeview Crescent #6, Mississauga, Ontario L5N 2L8, ☎ (905) 569-0664, Toll Free: (866) 260-6069, ☐ Fax: (905) 569-0665

Tuttnauer USA Co., Ltd., 25 Power Drive Hauppauge, NY 11788, USA
(800) 624 5836, (631) 737 4850, Fax: (631) 737 0720
e-mail: info@tuttnauerUSA.com.

Note:

If you have any questions or there are any difficulties with this instrument and the solution is not covered in this manual, please contact your dealer or Heidolph.

Do not attempt to service this instrument yourself.

If there is any difficulty with this instrument, and the solution is not covered in this manual, contact our representative or us first. Do not attempt to service this instrument yourself. Describe the difficulty as clearly as possible so we may be able to diagnose the problem and provide a prompt solution.

If the autoclave is equipped with a printer, send along a copy of the last printout for our inspection. If replacement parts are needed, stipulate the model and serial number of the machine.

No products will be accepted for repair without proper authorization from us. All transportation charges must be paid both ways by the owner. This warranty will be void if the unit is not purchased from an authorized full service **Tuttnauer** dealer.

1.6 Ordering Information

Several items must be specified when ordering the unit from your dealer.

- The chamber diameter and chamber depth required
- Please specify the supply voltage available (i.e. 115v/208v; 1Ph/3Ph)
- The temperature scale needed (Celsius or Fahrenheit).
- The pressure scale needed (kPa or psi)

1.7 Accessories

- Baskets – Different size baskets are available for these units. The baskets are made of stainless steel wire and have a handle. The basket allows the operator to load a large quantity of materials into the chamber.
The baskets are made of stainless steel wire and have a handle. The basket allows the operator to load a large quantity of materials into the chamber.
- Stainless steel containers - Different size containers are available for these units .
The containers are designed for sterilizing waste material. The containers have vent holes along the upper rim.

2. Safety Instructions

The autoclave has unique characteristics. Please read and understand the operation instructions before first operation of the autoclave. The following issues may require instructions guidance provided by the manufacturer: how to operate the autoclave, the door safety mechanism, the dangers involved in circumventing safety means, how to ensure that the door is closed, and how to select a correct sterilization program.

Make sure that you know where the main power switch is, where the water cut-off valve is and where the compressed air disconnection valves (if applicable) are located.

Autoclave maintenance is crucial for the correct and efficient function of the device. We enclose a log booklet that includes maintenance recommendations, with every device.

The weekly spore test is part of the preventive maintenance plan, along with the annual validation of the sterilization processes that ensures appropriate temperature dispersion within the chamber.

Never use the autoclave to sterilize corrosive products, such as: acids, bases and phenols, volatile compounds or solutions such ethanol, methanol or chloroform nor radioactive substances.

1. Never start using a new autoclave before the safety, licensing and authorization department has approved it for use.
2. All autoclave users must receive training in proper usage from an experienced employee. Every new employee must undergo a training period under an experienced employee.
3. A written procedure must be established for autoclave operation, including: daily safety tests, seal inspection and door hinge inspection, smooth action of the closing mechanism, chamber cleaning, prevention of clogging and preservation from corrosion, what is permitted and what is prohibited for sterilization and choosing a sterilization program.
4. Liquids may be sterilized only with the “liquids” programs. The container must be covered but not sealed. Sealed bottles may only be sterilized using a special program. The bottle must be either Pyrex or a Borosilicate glass bottle. Verify that the two temperature sensors are located inside two different bottles to assure that the liquid temperature is 20°C below boiling temperature for sealed bottles at the end of the cycle.
5. When sterilizing plastic materials, make sure that the item can withstand sterilization temperature. Plastic that melts in the chamber is liable to cause a great deal of damage.
6. Individual glass bottles may be placed within an appropriate container that will be placed in a basket. Never place glass bottles on the floor of the autoclave. Never fill more than 2/3 of the bottle volume.

7. On closing the autoclave's door, make sure it is properly locked before activating.
8. Before withdrawing baskets, wear heat resistant gloves.
9. Before opening the door, verify that there is no pressure in the chamber (chamber pressure gauge is located on the autoclave's front panel or door, depends on model).
10. Open the door slowly to allow steam to escape and wait 5 minutes before you remove the load. When sterilizing liquids, wait 10 minutes.
11. Once a month, ensure that the safety valves are functioning, and once annually a certified tester must conduct pressure chamber safety tests.
12. Once annually, or more frequently, effective tests must be performed, i.e., calibration and validation.
13. Examine the condition of assemblies on a regular basis. Make sure there are no leaks, breaks, blockages, whistles or strange noises.
14. It is required to conduct maintenance operations as instructed.
15. Immediately notify the person in charge of any deviation or risk for the proper function of the device.
16. For WR models, drain the water from the mineral free water reservoir once a week, and refill with fresh mineral-free water or distilled water (see 10.1).
17. This autoclave equipped with rear and front wheels, when moving the autoclave all utilities must be disconnected, at least 2 persons shall move the autoclave with caution. When the autoclave located in the required place, the wheels have to be locked. For further information see the front/rear view of the autoclave.

3. Technical Data

3.1 Storage Conditions



The packed or unpacked autoclave shall be retained in indoor conditions!

3.2 Operating Conditions

- The autoclave is intended to work in 'indoor' conditions only.
- Only autoclavable materials shall be used.
- The environment shall not exceed an ambient temperature range of 5°C (41°F)-40°C (104°F) and a relative humidity of 85% respectively.
- The operation altitude shall not be over 2000 meters (6561 feet) (ambient pressure shall not be lower than 80 kPa (11.6 psi)).
- The autoclave shall not be used in a manner not specified in this manual!
- Do not use the autoclave in the presence of dangerous gases.
- The packed or unpacked device shall be stored in 'indoor' conditions.
- Operate the autoclave only in the manner specified in the manual. If the equipment is used in a manner not specified by the manufacturer, the protection provided by the equipment may be impaired.



Caution!

Waste water should be brought into the public net in accordance with the local rules or requirements i.e. only non-hazardous liquids shall be disposed in public sewage!

3.3 Directives and Standards

Tuttnauer. Ltd. company meets the provisions of the following standards:

ISO 9001:2008 (Quality Systems)

Tuttnauer. Ltd. company also works in conjunction with and refers to:

ANSI/AAMI ST55 American Society of Mechanical Engineers
Section VIII, Division 1, for unfired pressure vessels.

EN 13060	Small Steam Sterilizers.	
UL	UL 61010-1	
PED	97/23EEC	
IEC	IEC 61010-2-040 Safety	
ISO	17665-1:2006	(Validation and Routine Control)

3.3.1 Quality standards

The manufacturing plant meets the following quality standards:

1. EN ISO 9001:2008– Quality System
2. ISO 13485:2003 – Quality systems – Medical devices.

3.4 Environment Emission Information

- A. Peak sound level generated by the sterilizer is « 70 / dBA with a back sound level of 60 dBA.
- B. Total heat transmitted by the sterilizer is < 600 W/h

3.5 Electrical Data

230V configuration

Property	Value: 3840	Value: 3850	Value: 3870
Total Power	6000W (3*2000W)	6000W (3*2000W)	6000W (3*2000W)
Voltage	1Ph, 230VAC	1Ph, 230VAC	1Ph, 230VAC
Amperage	15A	15A	15A
Protection against electrical shock	Class I (IEC 60601-1)		
Mains supply fluctuation	+/- 10%		
Degree of protection by enclosure	IP31		

400V configuration

Property	Value: 3840	Value: 3850	Value: 3870
Total Power	6000W (3*2000W)	6000W (3*2000W)	6000W (3*2000W)
Voltage	3Ph, 400VAC	3Ph, 400VAC	3Ph, 400VAC
Amperage	9A	9A	9A
Protection against electrical shock	Class I (IEC 60601-1)		
Mains supply fluctuation	+/- 10%		
Degree of protection by enclosure	IP31		

3.6 Water Quality

The distilled or mineral-free water supply shall be according to the table below:

Physical Characteristics and Maximum acceptable contaminants levels in water or steam, for steam generator and sterilizers (According to EN 285: 2006)

	Contaminants in water supplied to generator	Contaminants in condensate at steam inlet to sterilizer
Evaporate residue	≤ 10 mg/l	N/A
Silicate (SiO₂)	≤ 1 mg/l	≤ 0.1 mg/l
Iron	≤ 0.2mg/l	≤ 0.1mg/l
Cadmium	≤ 0.005 mg/l	≤ 0.005 mg/l
Lead	≤ 0.05 mg/l	≤ 0.05 mg/l
Rest of heavy metals except iron, cadmium, lead	≤ 0.1 mg/l	≤ 0.1 mg/l
Chloride (Cl)	≤ 2 mg/l	≤ 0.1 mg/l
Phosphate (P₂O₅)	≤ 0.5 mg/l	≤ 0.1 mg/l
Conductivity (at 25°C)	≤5 µs/cm	≤ 3 µs/cm
pH value (degree of acidity)	5 to 7.5	5 to 7

Hardness (Σ ions of alkaline earth)	≤ 0.02 mmol/l	≤ 0.02 mmol/l
Appearance	Colorless, clean, without sediments	
[Minimum specific resistivity of 1 megohm per cm (1 M Ω /cm)]		

Compliance with the above data should be tested in accordance with acknowledged analytical methods, by an authorized laboratory.



Attention:

The use of water for autoclaves that do not comply with the table above may have severe impact on the working life of the sterilizer and can invalidate the manufacturer's guarantee.

Use only deionized water, Having a maximum conductance of 1 microSiemen per cm (1 μ S/cm) Tap Water supply

Maximum hardness value 0.7-2.0 mmol/l

The use of soft water is strictly forbidden!

Please consult a water specialist!

3.6.1 Reverse Osmosis

A Reverse Osmosis (RO) system may be used to improve the quality of the water used to generate steam in the autoclave chamber.

In RO, the water is forced through a semi-penetrable membrane, which filters out contaminants to a high degree of efficiency. In deionisation (DI) ions and charged particles are removed either by electric fields or by ion exchange in resin beds.

Although the RO cannot normally attain the degree of purity possible with the DI methods, it is more than adequate for the feed water intended for clean-steam generators.

Moreover the RO has several advantages:

1. RO is cheaper to install and to run than DI.
2. RO removes particulate matter, organic molecules and pyrogens that DI cannot remove
3. RO water is less corrosive to steel and copper than DI water.
4. RO maintenance requirements are less demanding than those of the DI units.

Therefore the use of mineral free water will contribute to better performance and longer life of the autoclave.

3.7 Specifications

Model		Property		
		3840	3850	3870
Overall dimensions (standard configuration)	Height	900mm	900mm	1000mm
	Width	730mm	730mm	730mm
	Length	540mm	540mm	540mm
Overall dimensions (WR configuration)	Height	1080mm	1080mm	1080mm
	Width	730mm	730mm	730mm
	Length	7300mm	7300mm	7300mm
Maximum dimensions (door open)	Width	800mm	800mm	800mm
	Height	1400mm	1400mm	1500mm
Net weight		105kg	108kg	113kg
Weight per support area (max. load)		According to overall weight and floor loading requirements		
Shipping volume		0.9 m3	0.9 m3	0.9 m3
Shipping weight		133kg	136kg	141kg
Shipping dimensions	length	900mm	900mm	900mm
	width	730mm	730mm	730mm
	height	1350mm	1350mm	1350mm
Max. Allowable Working pressure (MAWP)		2.8 bar	2.8 bar	2.8 bar
Chamber	diameter	380mm	380mm	380mm
	Depth	400mm	490mm	690mm
Chamber Volume		52L	65L	85L

3.8 Construction

Chamber and door material	Stainless steel
Outer Cabinet	Stainless Steel
Chamber insulation	Fiberglass with reinforced material
Water reservoir	Stainless Steel

3.9 Utilities

3.9.1 Electrical utility

Power	Switch box	Recommended Circuit Breaker
208-220V (3 Ph + Earthing)	No	20A
400V(3 Ph + Neutral + Earthing)	No	16A
230V 1ph	No	16A
Frequency		50/60Hz

3.9.2 Other Utilities

Compressed Air (C, cooling models only)	1/2", 3 Bar (44-58 psi)
Tap water	1/2", 2-6 Bar (29-44 psi)
Mineral free water	1/2", 2-3 Bar (29-44 psi)
Drain	2" Minimum Withstanding temp. of 80°C (176°F)



Attention:

- ***A switch or circuit-breaker must be included in the building installation. This switch or circuit-breaker shall be in close proximity to the equipment, within easy reach of the operator; and marked as the disconnecting device for the equipment.***
- ***The electrical net must be protected with a current leakage safety relay.***
- ***The electrical network must comply with local rules or regulations.***
- ***Verify that there is an easy access to the main power switch, to the water cut-off valve and to the current leakage safety relay.***
- ***Make sure while placing the autoclave, to leave space around the machine, to give the technician access to service the machine.***
- ***All water connections to autoclave must be performed through "BACK FLOW PREVENTION SYSTEM" only, as per IEC 61770.***

3.10 Symbol Description



Caution! Consult accompanying documents



Caution! Hot surface.



Caution! Hot steam.



Protective earth (Ground)

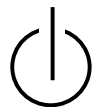

On-Off

3.11 Front View (Standard Configuration)

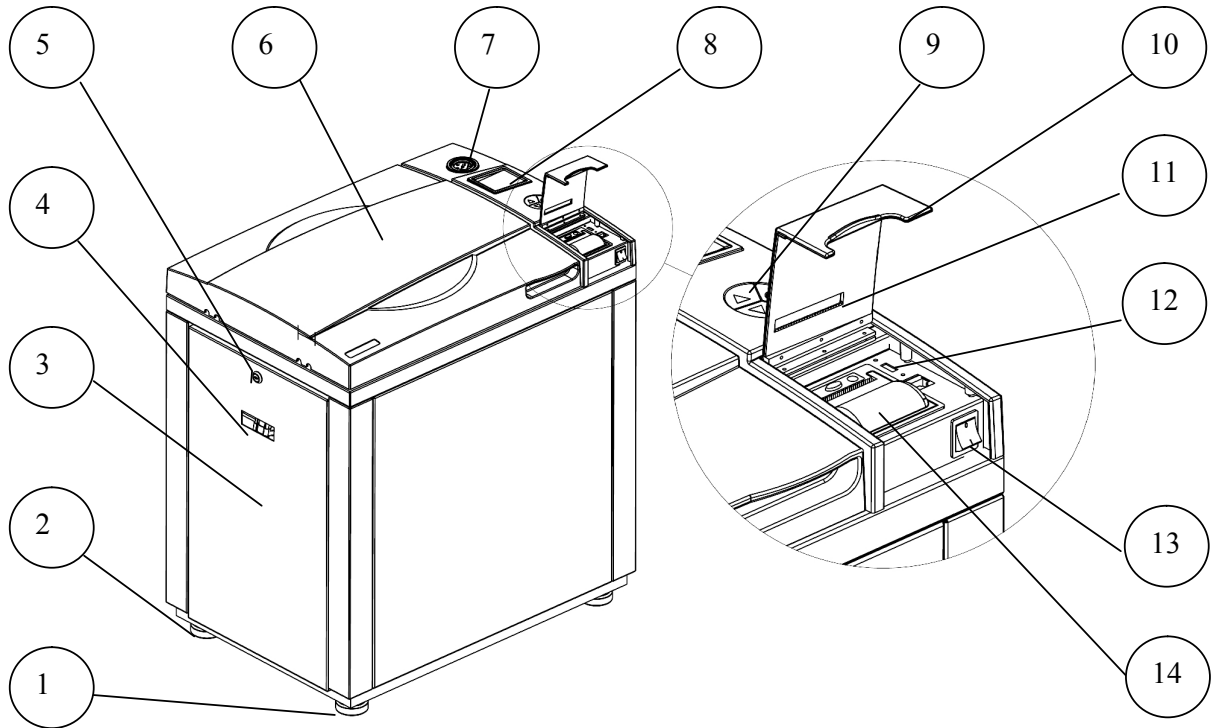

No.	Description		
1	Front leg	8	Display
2	Rear leg	9	Keyboard
3	Left service door	10	Printer cover
4	Left service door grip	11	Paper slot and paper cutter
5	Left service door lock	12	USB socket
6	Door cover	13	Main switch
7	Pressure gauge	14	Printer

3.12 Front View (WR Configuration, Outside Reservoir)

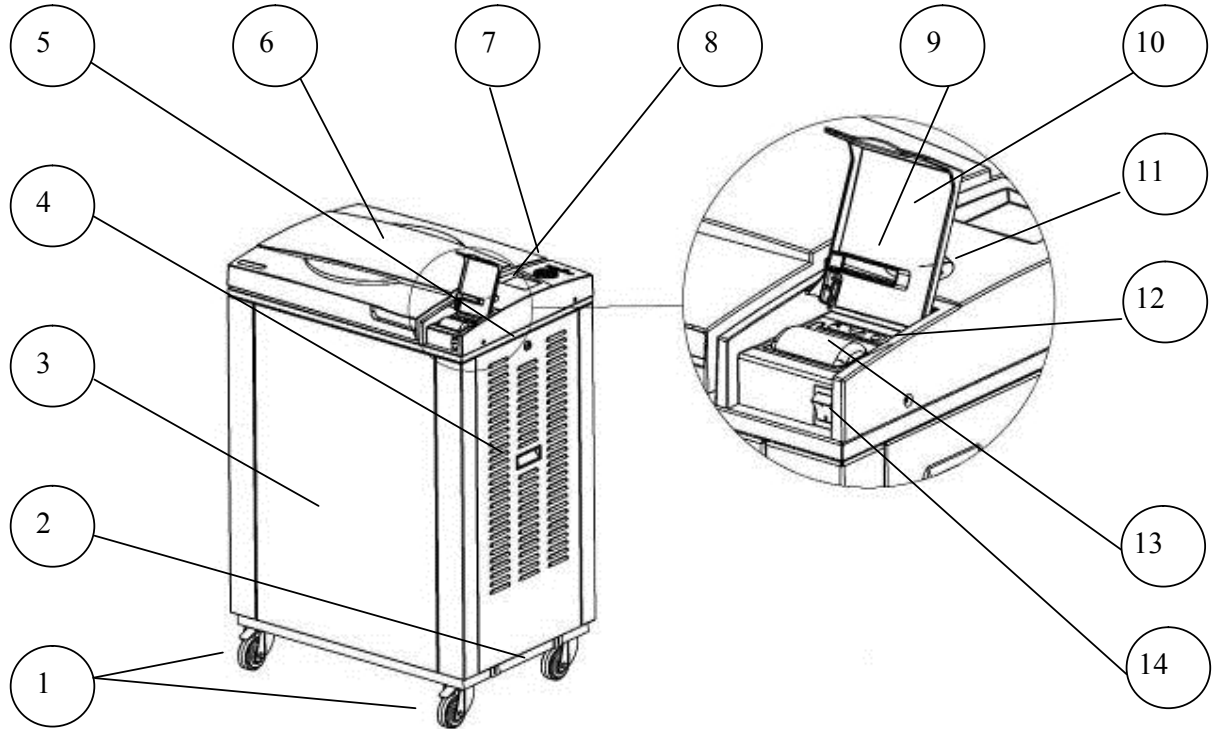

No.	Description	No.	Description
1	Front wheel (with brakes)	8	Display
2	Rear leg	9	Paper slot and paper cutter
3	Front service door	10	Printer cover
4	Right service door grip	11	Keyboard
5	Right service door lock	12	USB socket
6	Door cover	13	Printer
7	Pressure gauge	14	Main switch

3.13 Front View (WR Configuration, Inside Reservoir, Only Specific Items Are Shown)

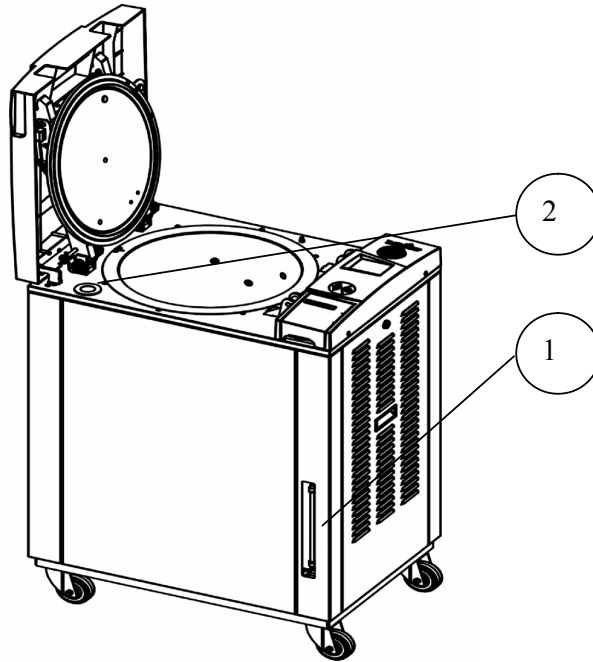

No.	Description
1	Glass tube indicator of the reservoir water level
2	Inlet for manual water reservoir filling

3.14 Front View (Fan Configuration)

There is a configuration equipped with a fan that allows to shorten the cooling operation. The fan is located on the door of the autoclave.



3.15 Rear View (Standard Configuration)

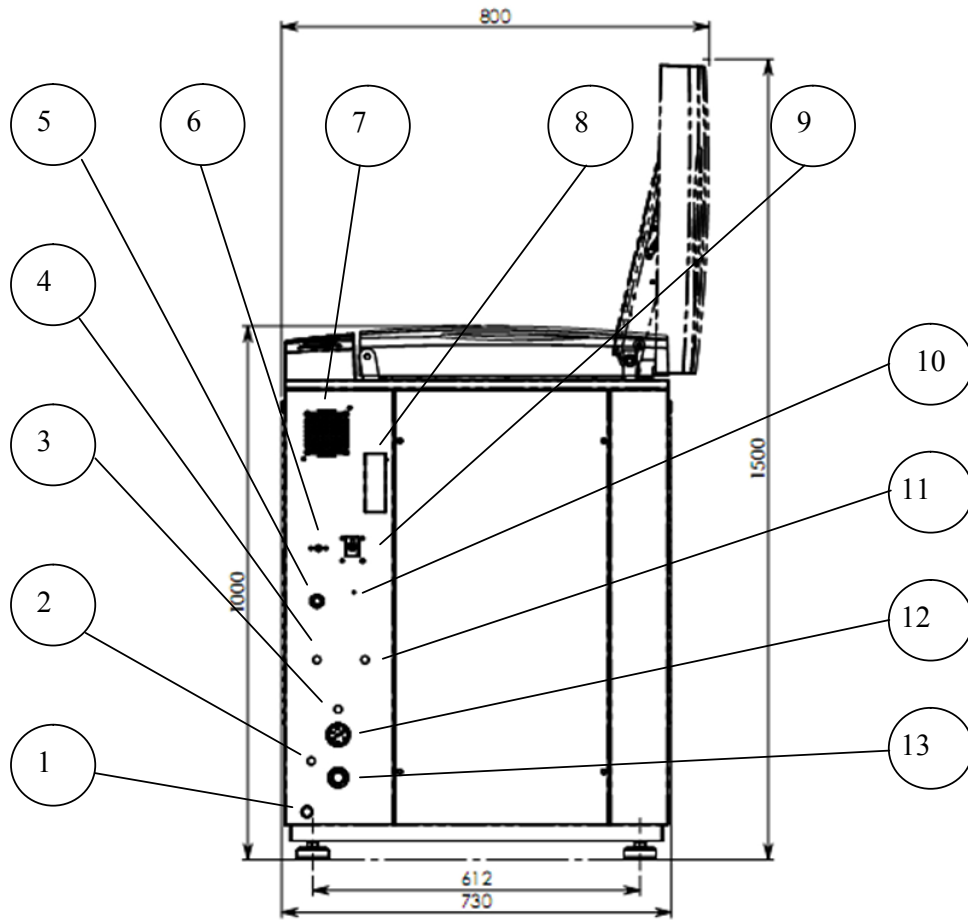

No.	Description	No.	Description
1	Drain outlet	8	Safety Valve
2	Mineral free water inlet	9	Circuit breaker
3	Compressed air inlet	10	Ground connector
4	Cavitation port	11	City (tap) water inlet for cooling coil
5	Power supply electrical cord	12	Air pressure gauge
6	Cut-off	13	Air pressure regulator
7	Fan grill		

3.16 Rear View (WR Configuration, Outside Reservoir)

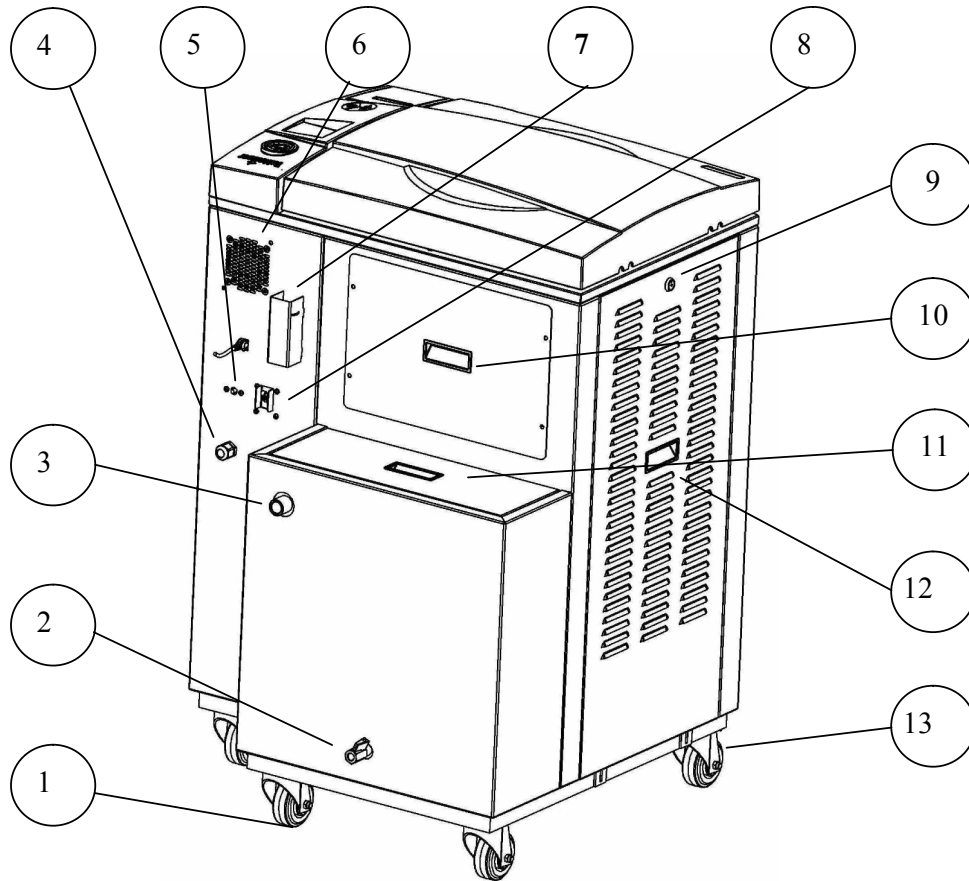

No.	Description
1	Rear wheel
2	Water reservoir drain
3	Water reservoir overflow
4	Power supply electrical cord
5	Cut-off
6	Fan grill
7	Safety valve
8	Circuit breaker
9	Left service door lock
10	Back service door handle
11	Water reservoir door handle
12	Left service door handle
13	Front wheel (with brakes)

3.17 Rear View (WR Configuration, Inside Reservoir, Only Specific Items Are Shown)

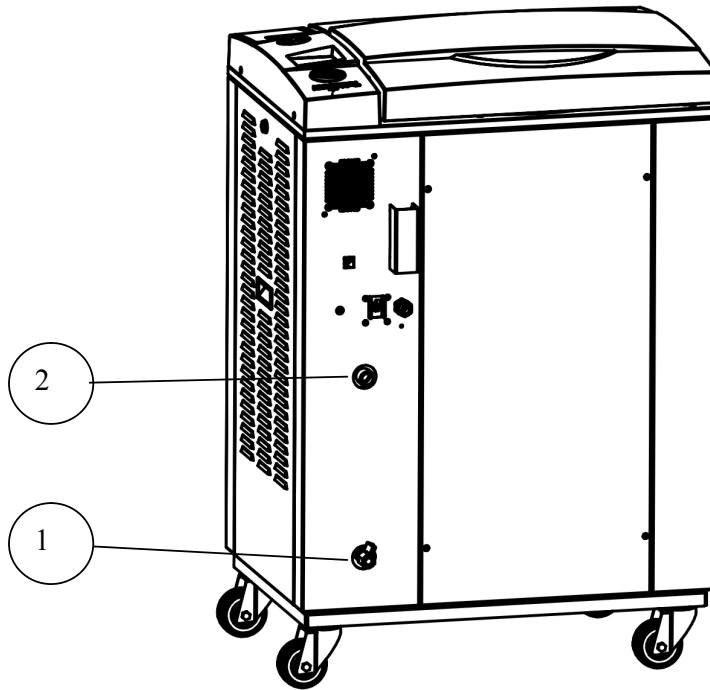

No.	Description
1	Water reservoir drain outlet
2	Water reservoir overflow

3.18 Overall Dimensions (3850ELVC-D & WR Configuration, Inside Reservoir), mm

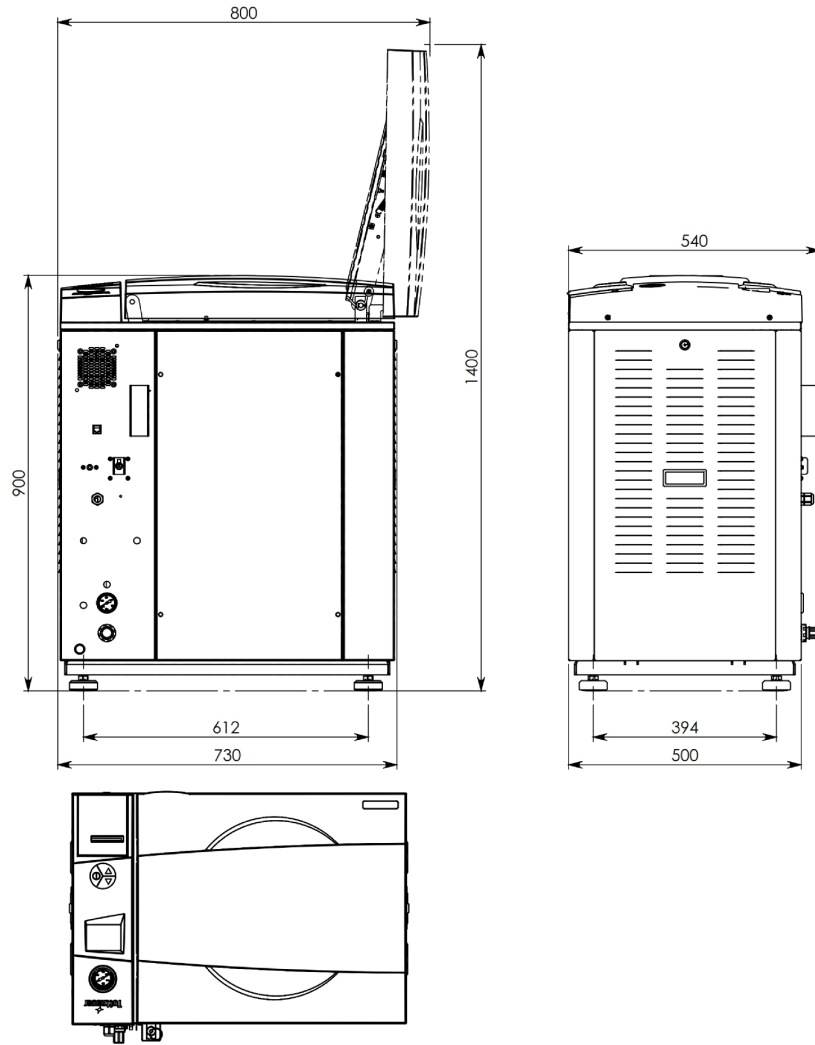

3.19 Overall Dimensions (3870ELVC-D, mm)

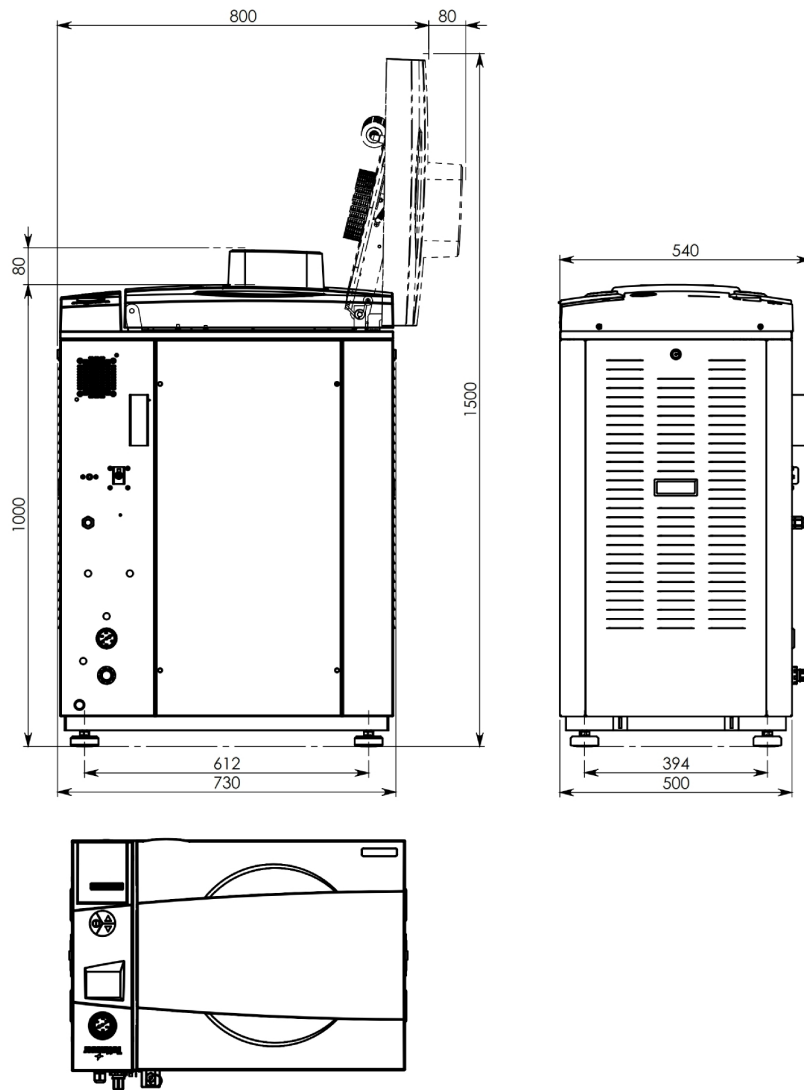

3.20 Overall Dimensions (3870ELV-PRC-D, mm)

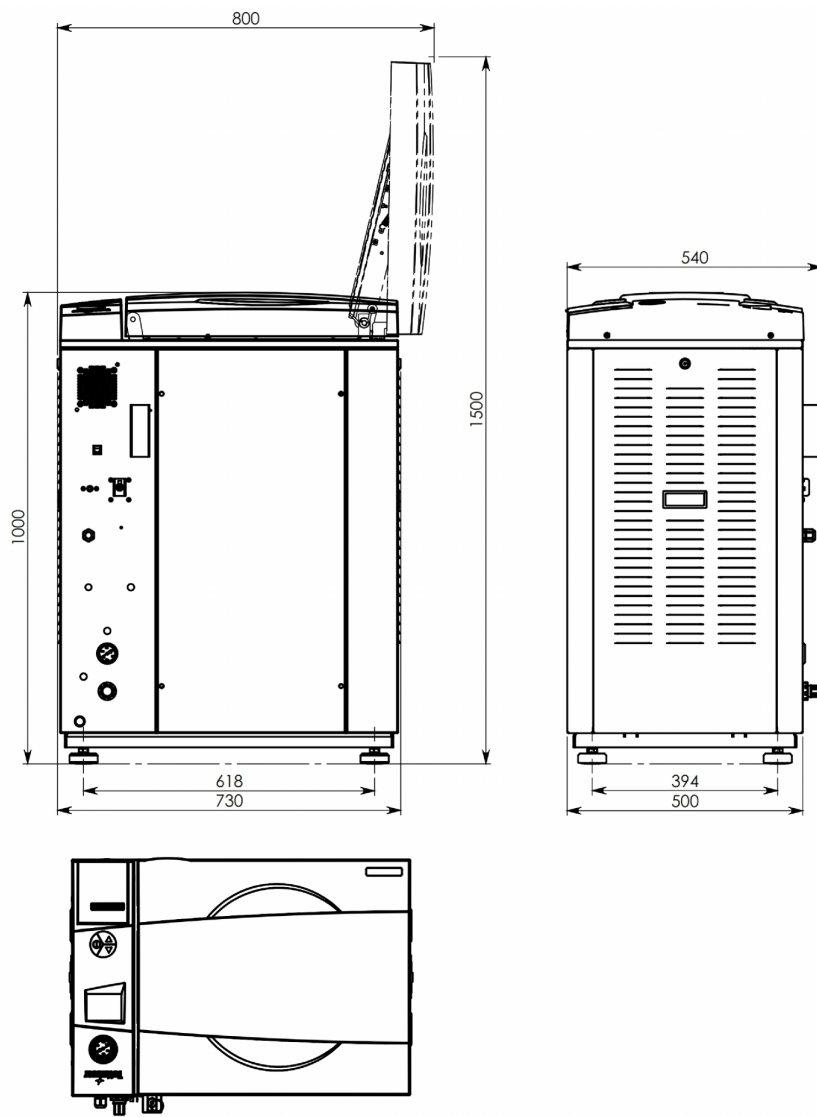

3.21 Overall Dimensions (WR configuration, mm)

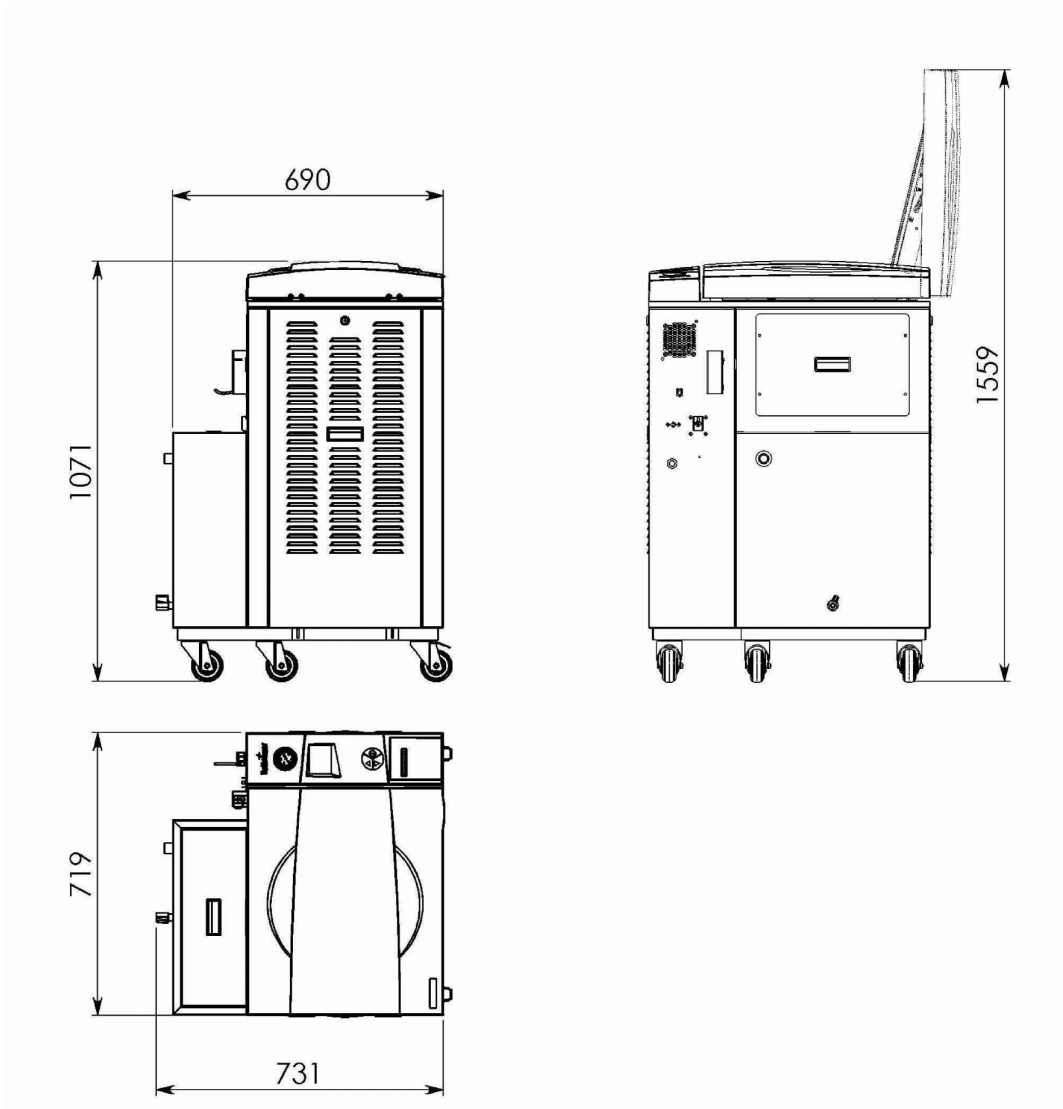

3.22 Safety Features

This autoclave includes built-in safety features such as:

- ◆ Error message display.
- ◆ Electronic pressure and temperature measurement.
- ◆ Safety relief valve to avoid build-up of excessive pressure.
- ◆ Door switches enabling operation to be started only when the door is closed.
- ◆ Water level safety device.
- ◆ Excess temperature protection.

4. Control Panel

4.1 Control Panel Drawing

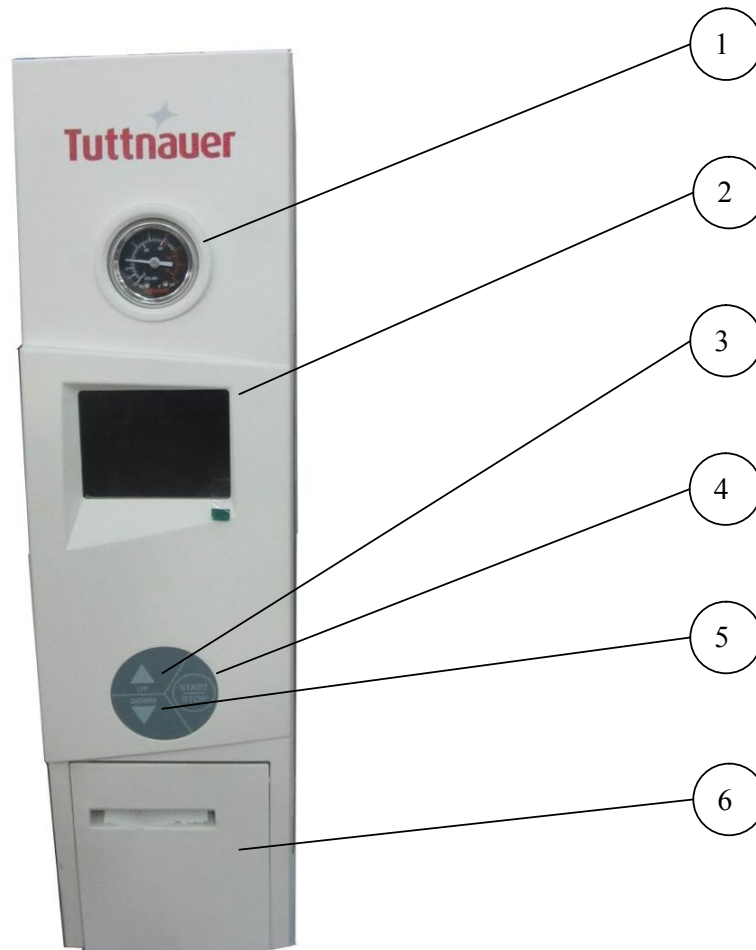

No.	Description
1	Pressure Gauge
2	Display
3	Keypad: Up Button
4	Keypad: Start/Stop Button
5	Keypad: Down Button
6	Printer

4.2 Description and Functions of the Front Panel Keyboard

The front panel is composed of 3 sections:

1. Display screen.
2. Keypad.
3. Printer

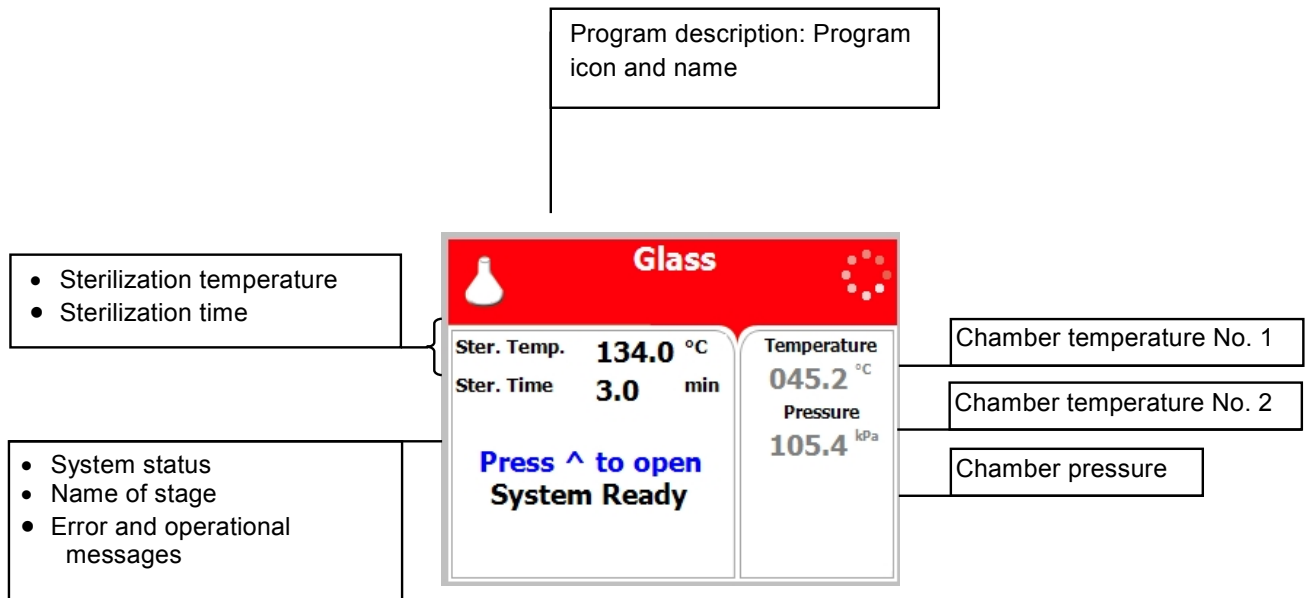

4.2.1 Display screen

The display is a LCD panel used to display the current status of the autoclave while using Operational Messages and Error Messages.



4.2.2 Keypad

The keypad consists of three keys as described below:

<p>UP key</p> <p>This key has the following functions:</p> <ul style="list-style-type: none"> • In the menu directories: <ul style="list-style-type: none"> ○ This key enables the operator to browse through the cycles. • In the directories available: <ul style="list-style-type: none"> ○ When the cursor is blinking on a number, the UP ▲ key increases its value. ○ When the cursor is blinking on a menu selection, the UP ▲ key allows browsing backward through the menu. ○ When adjusting a parameter and the cursor is blinking on “SET” or “EXIT” the UP ▲ key activates that procedure.” 	
<p>DOWN key</p> <p>This key has the following functions:</p> <ul style="list-style-type: none"> • In the menu directories: <ul style="list-style-type: none"> ○ This key enables the operator to browse through the cycles. • In the directories available: <ul style="list-style-type: none"> ○ When the cursor is blinking on a number, the DOWN ▼ key decreases its value. ○ When the cursor is blinking on menu selection, the DOWN ▼ key allows browsing forward through the menu. ○ When adjusting a parameter and the cursor is blinking on “SET” or “EXIT” the DOWN ▼ key activates that procedure. 	
<p>START/STOP key</p> <p>This key has the following functions:</p> <ul style="list-style-type: none"> • In the main screen: <ul style="list-style-type: none"> ○ Starts the process when the required program was chosen. ○ Stops the current process. ○ Cancels the ERROR message displayed on the screen and opens the electric door lock. • In the menu directories: <ul style="list-style-type: none"> ○ When the cursor is blinking on a number, the START/STOP ⓘ key enables moving to the next position. ○ When the cursor is blinking on a menu selection, the START/STOP ⓘ key activates that selection. 	

4.2.3 Printer

The printer is an optional device.

It prints the detailed history of each cycle performed by the autoclave. The printing is on thermal paper with 24 characters per line and records the sterilization cycle information for subsequent consideration.



4.3 Displayed Error Messages / Symbols

The failures are divided into two categories.

- a. Failure that occur before completing the sterilization stage, which in this case will leave the load unsterilized
- b. Failure that occur after completing the sterilization stage, which in this case will leave the load sterilized







For the list of *Displayed Error Messages / Symbols* see 0. **TROUBLESHOOTING**







4.4 Displayed operational messages / Symbols

Message / Symbol Name	Message / Symbol Description	Required Action
	This symbol is displayed when the door is open.	Close the door.
	This symbol is displayed when there is water in chamber.	Repeat the cycle
Door is open (during stand by)	This message is displayed when the door is opened: In standby - if START/STOP is preset.	Close the door to perform a new cycle.
Cycle Ended	This message is displayed when the cycle ended successfully.	Press START/STOP in order to perform a new cycle.
Test Ended	This message is displayed when the test ended.	Press START/STOP in order to perform a new test
	This symbol is displayed when Cycle by Clock mode is performed.	Enter the Admin menu as described in this manual to change the time or to cancel this option.

<p>Cycle by clock</p>	<p>This message is displayed if the user presses START/STOP key while the "cycle by clock" mode is active.</p>	<p>Enter the Admin menu as described in this manual to change the time or to cancel this option.</p>
<p>Atmospheric pressure not set</p>	<p>This message is displayed in order to set the atmosphere pressure by opening the door for 5 minutes.</p>	<p>Open the door for 5 minutes in order to set the Atmospheric pressure.</p>
<p>Critical settings have been updated, Please restart machine in order for changes to be updated</p>	<p>If a change of the autoclave setting was made, a restart operation is required.</p>	<p>Restart the autoclave in order for changes to be updated.</p>
	<p>This message is displayed if the electrode in the chamber senses water.</p>	<p>Perform a new cycle to drain the chamber.</p>
<p>Supplied Distilled Water Error</p>	<p>Mineral free water reservoir empty"</p>	<p>Fill the mineral free water reservoir.</p>

5. Sterilization Programs

Sterilization Programs			Temp.	Sterilization Time (minutes)	Drying Time (minutes)	C models only	PV models only	BH models only
Icon	No.	Description						
	1.	Glass	134°C (273°F)	3	1			
	2.	Plastic	121°C (250°F)	15	1			
	3.	Liquid A	121°C (250°F)	15				
	4.	Liquid B – Waste*	121°C (250°F)	30				
	5.	Liquid A – Cooling*	121°C (250°F)	15		√		
	6.	Liquid B Waste Cooling*	121°C (250°F)	30		√		
	7.	Bio Hazard 1*	134°C (273°F)	30	1			√
	8.	Bio Hazard 2*	121 (250°F)	45	1			√

Sterilization Programs			Temp.	Sterilization Time (minutes)	Drying Time (minutes)	C models only	PV models only	BH models only
Icon	No.	Description						
	9.	Bio Hazard Liquids*	121 (250°F)	45				√
	10.	Vacuum test (PV only)*		5			√	
	11.	Warm-Up*	80 °C (176°F)	20				
	12.	Isothermal*	80 °C (176°F)	20				
	13.	Air Mixture*	121°C (250°F)	15				
	14.	Glass Test*	121°C (250°F)	20				
	15.	Durham*	121°C (250°F)	15				

***These programs are optional**

During the process, the stages of the cycle will be displayed on the screen:

The stages names are as follows:

- Start
- Pulse Low (PV models only)
- Pulse High (PV models only)
- Water Inlet
- Heating
- Sterilization
- Cooling (C models only)
- Exhaust
- Drying (PV model only)
- Ending

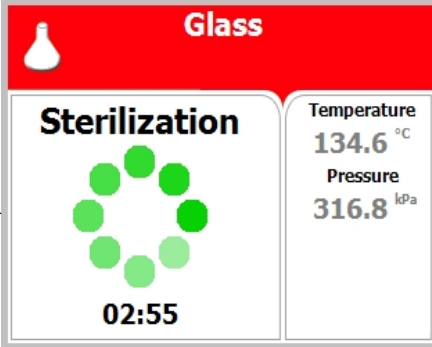

5.1 Program 1: Glass

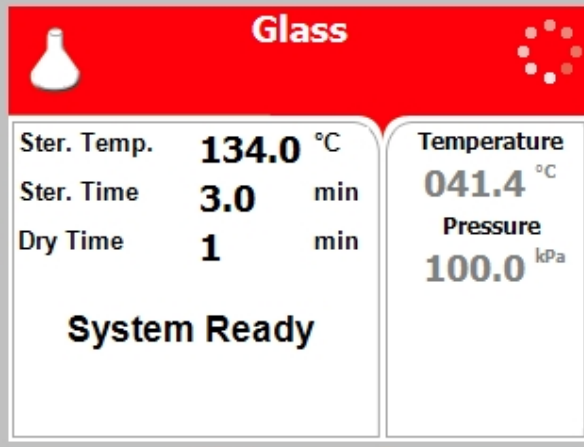

For glass instruments, when the manufacturer recommends autoclaving at temperatures of 134°C (273°F). Drying stage is available for PV (pre-vacuum) models only.

Nominal parameters default settings

- Sterilization temperature: 134°C (273°F).
- Sterilization time: 3 minutes.
- Drying time: 1 minute. (PV – pre-vacuum models only).

Operations sequence:

- (PV, pre-vacuum models only) **Pulse low/Pulse high:** at one pulse it will build vacuum down to 25 kPa.
- **Water Inlet:** Water enters the chamber
- **Heating:** The chamber and is heated by actuation of electrical heaters until the sterilization temperature is reached.
- **Sterilization:** Sterilization temperature is maintained constant during the sterilization time.
- **Cooling:** N/A.
- **Fast Exhaust:** the steam is exhausted out of the chamber at a fast rate until pressure decreases to ambient pressure.
- (PV, pre-vacuum model only) **Drying:** vacuum is built up and the air pump is working.
- **Ending:** The system checks that End temperature and End pressure have been reached, and then releases the door.

5.2 Program 2: Plastic

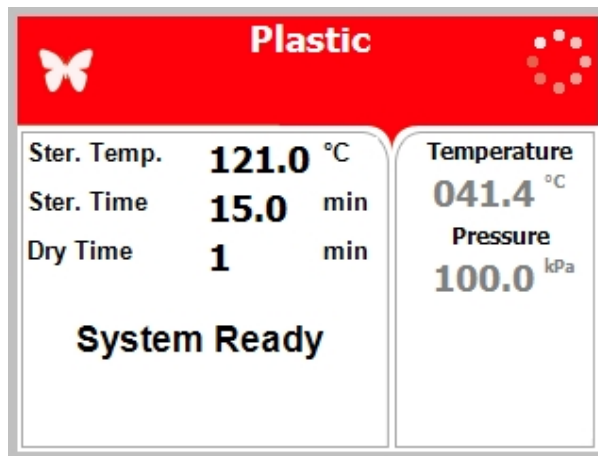

For plastic and other delicate instruments, when the manufacturer recommends autoclaving at temperatures of 121°C (250°F). Drying stage is available for PV (pre-vacuum) models only.

Nominal parameters default settings

- Sterilization temperature: 121°C (250°F)
- Sterilization time: 15 minutes
- Drying time: 1 minute (PV – pre-vacuum models only).

Operations sequence:

- (PV, pre-vacuum models only) **Pulse low/Pulse high:** at one pulse it will build vacuum down to 25 kPa.

- **Water Inlet:** Water enters the chamber
- **Heating:** The chamber is heated by actuation of electrical heaters until the sterilization temperature is reached.
- **Sterilization:** Sterilization temperature is maintained constant during the sterilization time.
- **Cooling:** N/A
- **Fast Exhaust:** the steam is exhausted out of the chamber at a fast rate until pressure decreases to ambient pressure.
- (PV, pre-vacuum models only) **Drying:** vacuum is built up and the air pump is working.
- **Ending:** The system checks that End temperature and End pressure have been reached, and then releases the door.

5.3 Program 3: Liquid A

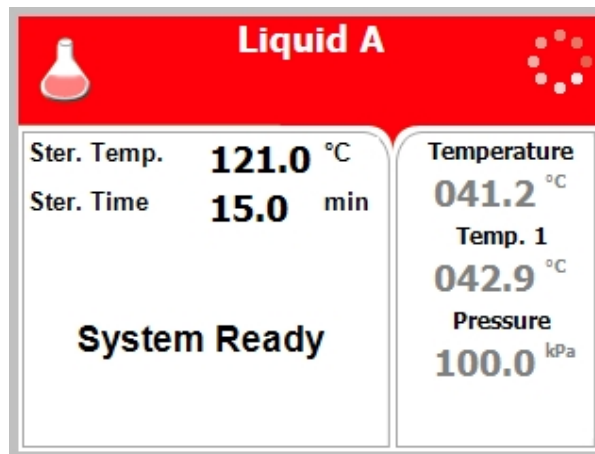

For liquids when the manufacturer recommends autoclaving at temperatures of 121°C (250°F) for 15 minutes.



Cautions!

Both PT100 temperature sensors must be inside the bottles.
For proper sterilization, fill the bottles with approximately the same amount of liquid.

Nominal parameters default settings

- Sterilization temperature: 121°C (250°F)
- Sterilization time: 15 minutes

Operations Sequence

- (PV, pre-vacuum models only) **Pulse low/Pulse high:** at one pulse it will build vacuum down to 25 kPa.
- **Water Inlet:** Water enters the chamber
- **Heating:** The chamber is heated by actuation of electrical heaters until the sterilization temperature is reached.
- **Sterilization:** Sterilization temperature is maintained constant during the sterilization time.
- **Cooling:** N/A
- **Slow Exhaust:** Steam is exhausted from the chamber at a slow rate, until it reaches the pressure of 30 kPa above the ambient pressure. Then steam is exhausted out of the chamber at a fast rate until pressure decreases to ambient pressure.
- **Drying:** N/A
- **Ending:** The system checks that End temperature and End pressure have been reached, and then releases the door.

5.4 Program 4: Liquid B – Waste

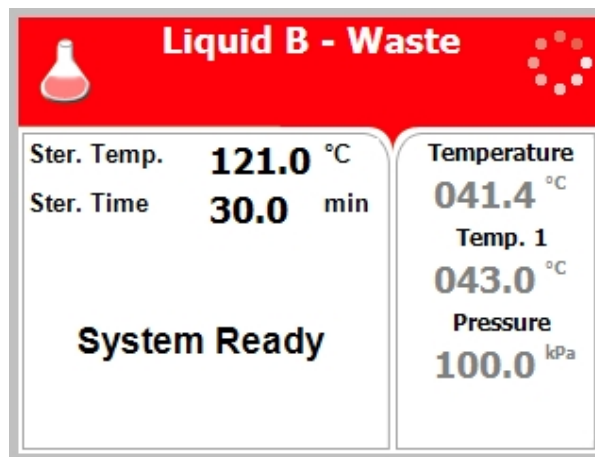

For liquids when the manufacturer recommends autoclaving at temperatures of 121°C (250°F) for 30 minutes, such as liquid waste.



Cautions!

Both PT100 temperature sensors must be inside the bottles.
For proper sterilization, fill the bottles with approximately the same amount of liquid.

Nominal parameters default settings

- Sterilization temperature: 121°C (250°F)
- Sterilization time: 30 minutes

Operations Sequence

- (PV, pre-vacuum models only) **Pulse low/Pulse high:** at one pulse it will build vacuum down to 25 kPa.
- **Water Inlet:** Water enters the chamber
- **Heating:** The chamber is heated by actuation of electrical heaters until the sterilization temperature is reached.
- **Sterilization:** Sterilization temperature is maintained constant during the sterilization time.
- **Cooling:** N/A
- **Slow Exhaust:** Steam is exhausted from the chamber at a slow rate, until it reaches the pressure of 30 kPa above the ambient pressure. Then steam is exhausted out of the chamber at a fast rate until pressure decreases to ambient pressure.
- **Drying:** N/A
- **Ending:** The system checks that End temperature and End pressure have been reached, and then releases the door.

5.5 Program 5: Liquid A – Cooling (C – cooling models only)

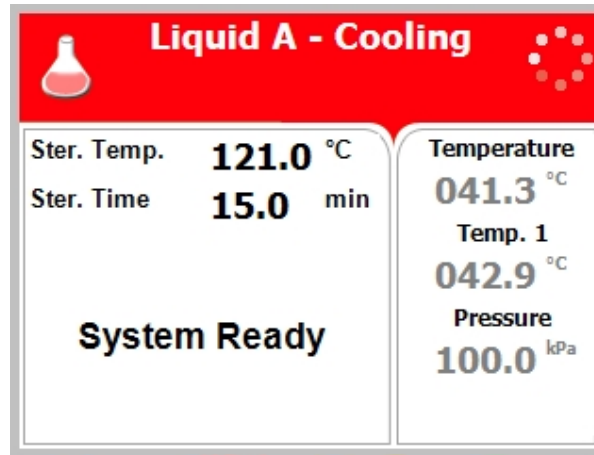

For liquids when the manufacturer recommends autoclaving at temperatures of 121°C (250°F). for 15 minutes.



Cautions!

Both PT100 temperature sensors must be inside the bottles.
For proper sterilization, fill the bottles with approximately the same amount of liquid.

Nominal parameters default settings

- Sterilization temperature: 121°C (250°F).
- Sterilization time: 15 minutes.

Operations sequence:

- (PV, pre-vacuum models only) **Pulse low/Pulse high:** at one pulse it will build vacuum down to 25 kPa.
- **Water Inlet:** Water enters the chamber
- **Heating:** The chamber is heated by actuation of electrical heaters until the sterilization temperature is reached.
- **Sterilization:** Sterilization temperature is maintained constant during the sterilization time.
- **Cooling:** Forced cooling to the required end temperature, chamber pressure remains at approx. 300 kPa and the cooling valve is opened.
- **Fast Exhaust:** the steam is exhausted out of the chamber at a fast rate until pressure decreases to ambient pressure.
- **Drying:** N/A
- **Ending:** The system checks that End temperature and End pressure have been reached, and then releases the door.

5.6 Program 6: Liquid B – Waste Cooling (C – cooling models only)

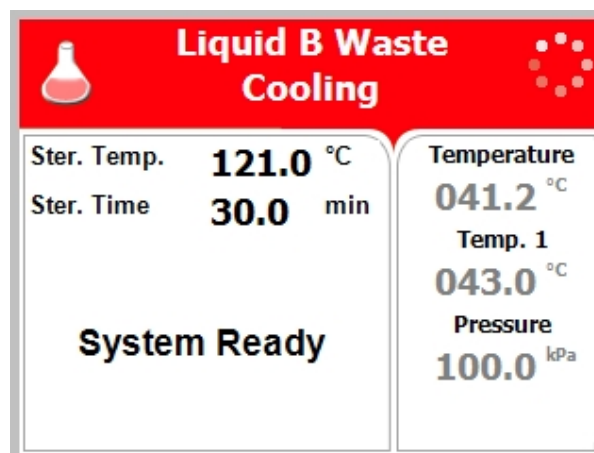

For liquids when the manufacturer recommends autoclaving at temperatures of 121°C (250°F) for 30 minutes, such as liquid waste.



Cautions!

Both PT100 temperature sensors must be inside the bottles.

For proper sterilization, fill the bottles with approximately the same amount of liquid.

Nominal parameters default settings

- Sterilization temperature: 121°C (150°F).
- Sterilization time: 30 minutes.

Operations sequence:

- (PV, pre-vacuum models only) **Pulse low/Pulse high:** at one pulse it will build vacuum down to 25 kPa.
- **Water Inlet:** Water enters the chamber
- **Heating:** The chamber is heated by actuation of electrical heaters until the sterilization temperature is reached.
- **Sterilization:** Sterilization temperature is maintained constant during the sterilization time.
- **Cooling:** Forced cooling to the required end temperature, chamber pressure remains at approx. 300 kPa and the cooling valve is opened.
- **Fast Exhaust:** the steam is exhausted out of the chamber at a fast rate until pressure decreases to ambient pressure.
- **Drying:** N/A
- **Ending:** The system checks that End temperature and End pressure have been reached, and then releases the door.

5.7 Program 7: Bio Hazard 1 (BH, bio-hazard models only)

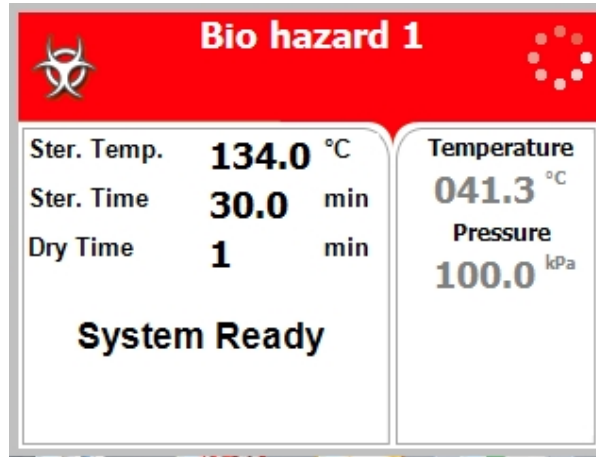

All exhaust from the chamber before completion of the Sterilization stage is performed through the bio-hazard filter. For instruments, when the manufacturer recommends autoclaving at temperatures of 134°C (273°F) for 30 minutes. Drying stage is available for PV (pre-vacuum) models only.

Nominal parameters default settings

- Sterilization temperature: 134°C (273°F)
- Sterilization time: 30 minutes
- Drying time: 1 minute. (PV – pre-vacuum models only).
-

Operations sequence:

- (PV, pre-vacuum models only) **Pulse low/Pulse high:** at one pulse it will build vacuum down to 25 kPa. **All exhaust from the chamber is performed through the bio-hazard filter.**
- **Water Inlet:** Water enters the chamber
- **Heating:** The chamber is heated by actuation of electrical heaters until the sterilization temperature is reached.
- **Sterilization:** Sterilization temperature is maintained constant during the sterilization time.
- **Cooling:** N/A
- **Fast Exhaust:** the steam is exhausted out of the chamber at a fast rate until pressure decreases to ambient pressure.

Note: If the cycle fails, fast exhaust is performed through the bio-hazard filter. Some water may remain in the chamber after a failed cycle. To

remove such water, press Start and repeat the cycle. If the problem persists, call for service.

- (PV, pre-vacuum models only) **Drying:** vacuum is built up and the air pump is working.
- **Ending:** The system checks that End temperature and End pressure have been reached, and then releases the door.

5.8 Program 8: Bio Hazard 2 (BH, bio-hazard models only)

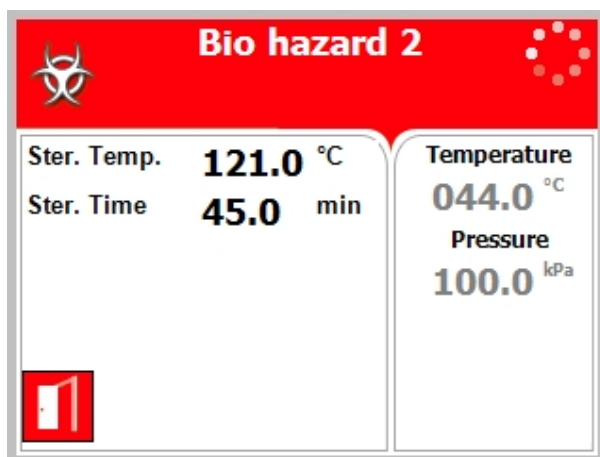

All exhaust from the chamber before completion of the Sterilization stage is performed through the bio-hazard filter. For instruments, when the manufacturer recommends autoclaving at temperatures of 121°C (250°F) for 45 minutes. Drying stage is available for PV (pre-vacuum) models only.

Nominal parameters default settings

- Sterilization temperature: 121°C (250°F)
- Sterilization time: 45 minutes
- Drying time: 1 minute. (PV – pre-vacuum models only).

Operations sequence:

- (PV, pre-vacuum models only) **Pulse low/Pulse high:** at one pulse it will build vacuum down to 25 kPa. **All exhaust from the chamber is performed through the bio-hazard filter.**
- **Water Inlet:** Water enters the chamber
- **Heating:** The chamber is heated by actuation of electrical heaters until the sterilization temperature is reached.
- **Sterilization:** Sterilization temperature is maintained constant during the sterilization time.

- **Cooling:** N/A
- **Fast Exhaust:** the steam is exhausted out of the chamber at a fast rate until pressure decreases to ambient pressure.
- **Note:** If the cycle fails, fast exhaust is performed through the bio-hazard filter. Some water may remain in the chamber after a failed cycle. To remove such water, press Start and repeat the cycle. If the problem persists, call for service.
- (PV, pre-vacuum models only) **Drying:** vacuum is built up and the air pump is working.
- **Ending:** The system checks that End temperature and End pressure have been reached, and then releases the door.

5.9 Program 9: Bio Hazard Liquids (BH, bio-hazard models only)

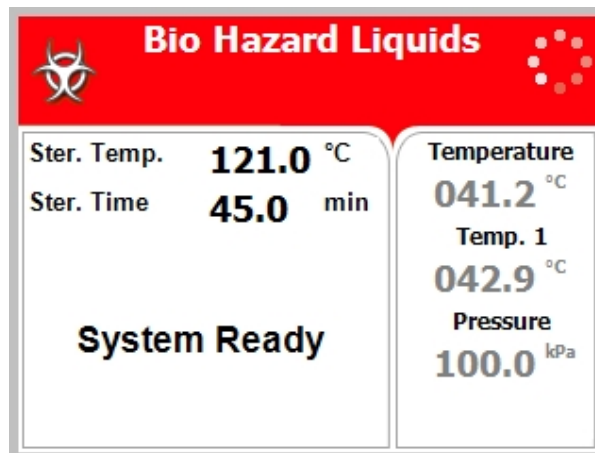

All exhaust from the chamber before completion of the Sterilization stage is performed through the bio-hazard filter. For liquids when the manufacturer recommends autoclaving at temperatures of 121°C (250°F) for 45 minutes.



Cautions!

Both PT100 temperature sensors must be inside the bottles. For proper sterilization, fill the bottles with approximately the same amount of liquid.

Nominal parameters default settings

- Sterilization temperature: 121°C (250°F)
- Sterilization time: 45 minutes

Operations sequence:

- (PV, pre-vacuum models only) **Pulse low/Pulse high:** at one pulse it will build vacuum down to 25 kPa. **All exhaust from the chamber is performed through the bio-hazard filter.**
 - **Water Inlet:** Water enters the chamber
 - **Heating:** The chamber is heated by actuation of electrical heaters until the sterilization temperature is reached.
 - **Sterilization:** Sterilization temperature is maintained constant during the sterilization time.
 - **Cooling:** N/A
 - **Slow Exhaust:** Steam is exhausted from the chamber at a slow rate, until it reaches the pressure of 30 kPa above the ambient pressure. Then steam is exhausted out of the chamber at a fast rate until pressure decreases to ambient pressure.
- Note:** If the cycle fails, fast exhaust is performed through the bio-hazard filter. Some water may remain in the chamber after a failed cycle. To remove such water, press Start and repeat the cycle. If the problem persists, call for service.
- **Drying:** N/A
 - **Ending:** The system checks that End temperature and End pressure have been reached, and then releases the door.

5.10 Program 10: Vacuum Test (PV, pre-vacuum models only)

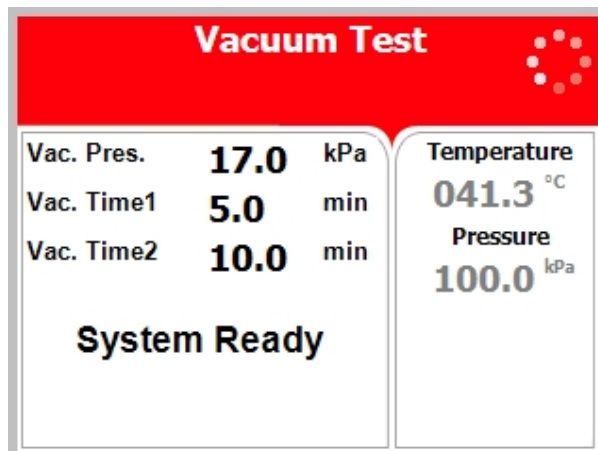

Vacuum Test is a test program with the following parameters:

Nominal parameters default settings

- Vacuum pressure: 17.0 kPa
- Vacuum time 1: 5 minutes
- Vacuum time 2: 10 minutes

Operations sequence:

- Vacuum is produced in the chamber down to P1=17 kPa. At this stage all the valves close. The autoclave remains in this stage for 5 minutes. This period enables the condition in the chamber to reach equilibrium.
- After the 5 minutes have elapsed, the printer records the pressure that is referred to as P2. At this point the test begins and lasts 10 minutes.
- At the end of the test, the printer records the results. The pressure at the end of the test is referred to as P3. The rate of change of P3-P2 shall not exceed 0.13 kPa/min.).

5.11 Program 11: Warm-Up

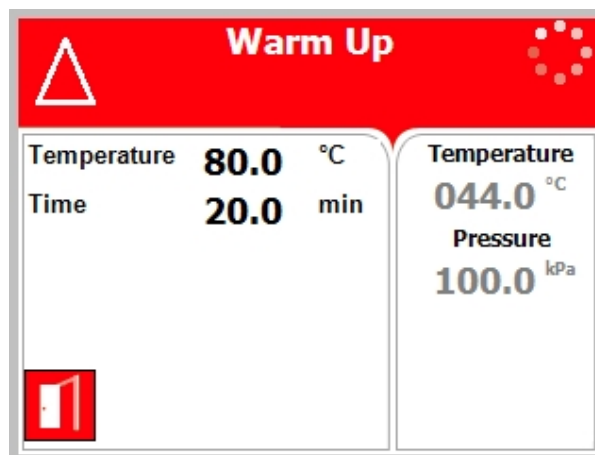

Pre-warming the chamber at 80°C (176°F) without drying.



Caution!

This is not a sterilization program!

Nominal parameters default settings

- Warm-up temperature: 80°C (176°F).
- Warm-up time: 20 minutes.

Operations sequence:

- **Pulse low/Pulse high:** N/A
- **Heating:** Water enters the chamber and is heated by actuation of electrical heaters until the warm-up temperature) is reached.
- **Warm up:** Warm up temperature is maintained constant for the warm-up time.
- **Sterilization:** N/A.
- **Cooling:** N/A.
- **Fast Exhaust:** the steam is exhausted out of the chamber at a fast rate until pressure decreases to ambient pressure.
- **Drying:** N/A.

Note: Some water may remain in the chamber.

5.12 Program 12: Isothermal

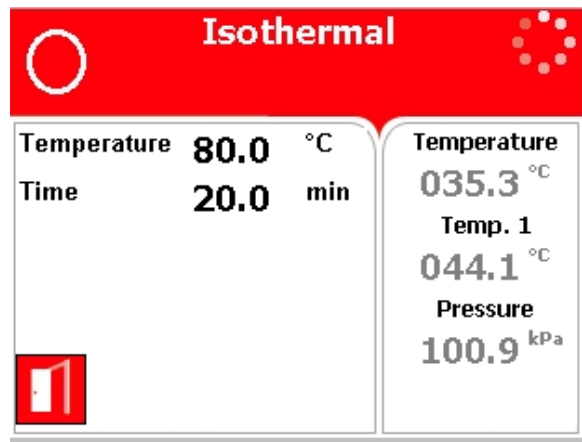

For liquids when the manufacturer recommends autoclaving at 60-100°C (140-212°F) with no drying. Recommending for melting of agar, pasteurization etc.



Caution!

This is not a sterilization program!

Put one PT100 inside the bottle, leave the second one hanging in the chamber outside the bottle (see below).



Nominal parameters default settings

- Heating temperature (default): 80°C (176°F).
- Heating time: 20 minutes.

Operations sequence:

- **Water Inlet:** Water enters the chamber
- **Heating:** The chamber is warmed up until the Keep-Heat temperature is reached inside the chamber.
- **Keep Heat:** Keep-Heat temperature is maintained constant for the preset Keep-Heat time.
- **Cooling:** N/A.
- **Fast Exhaust:** the steam is exhausted out of the chamber at a fast rate until pressure decreases to ambient pressure.
- **Drying:** N/A
- **Ending:** The system checks that End temperature and End pressure have been reached, and then releases the door.

Note: Some water may remain in the chamber.

5.13 Program 13: Air Mixture

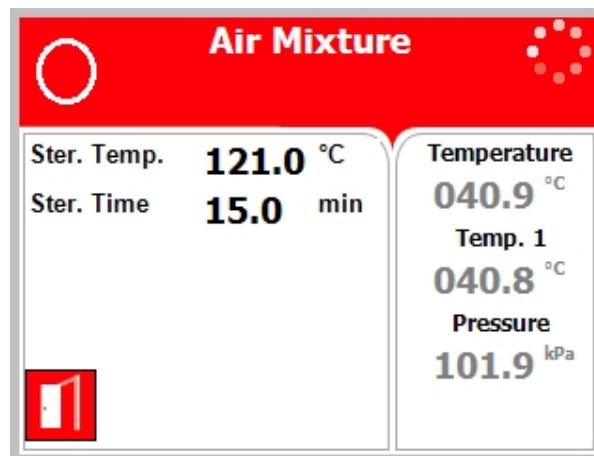

This program is intended for liquids in soft packages when the manufacturer recommends autoclaving at temperature of 121°C (250°F) for 15 minutes.

Sterilization is controlled in a way that the sterilization pressure remains approx. 30% above the theoretical pressure corresponding to the same temperature according to the steam table. These intends for prevent swelling or warping of the package.



Cautions!

Both PT100 temperature sensors must be inside the bottles.

For proper sterilization, fill the bottles with approximately the same amount of liquid.

Nominal parameters default settings

- Sterilization temperature: 121°C (250°F).
- Sterilization time: 15 minutes.

Operations sequence:

- **Heating:** Air enters the chamber followed by steam that heats it up until the sterilization temperature is reached. Air adds pressure needed to prevent swelling or warping of soft plastic items. Chamber fan is used to mix air with steam.
- **Sterilization:** Sterilization is controlled in a way that the sterilization pressure remains approx. 30% above the theoretical pressure corresponding to the same temperature according to the steam table.
- **Cooling:** Forced cooling to the required end temperature, chamber pressure remains at approx. 300 kPa and the cooling valve is opened.

- **Fast Exhaust:** The steam is exhausted out of the chamber at a fast rate until pressure decreases to ambient pressure.
- **Drying:** N/A
- **Ending:** The system checks that End temperature and End pressure have been reached, and then releases the door.

5.14 Program 14: Glass Test

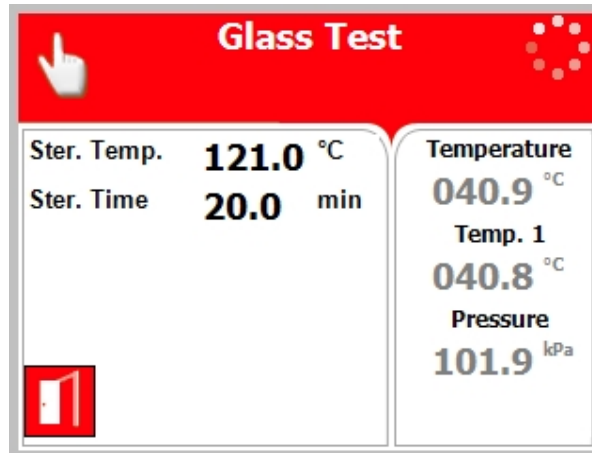

This cycle is intended to check the durability of the bottles for liquids when the manufacturer recommends autoclaving at temperatures of 121°C (250°F) for 20 minutes.



Cautions!

Both PT100 temperature sensors must be inside the bottles.
For proper sterilization, fill the bottles with approximately the same amount of liquid.

Nominal parameters default settings

- Sterilization temperature: 121°C (250°F).
- Sterilization time: 20 minutes.

Operations sequence:

- **Heating:** Steam enters the chamber and heats it up until the sterilization temperature is reached.
During the interval of the heating stage, between 100°C and 121°C, the heating rate is kept to approximately a rise of 1 degree per minute. This will make the last stage of the heating take approximately 21 minutes. This is to check the durability of the bottles.

- **Sterilization:** Sterilization temperature is maintained constant during the sterilization time.
- **Cooling:** Forced cooling to the required end temperature, chamber pressure remains at approx. 300 kPa and the cooling valve is opened.
During the interval of the cooling stage, between 121°C and 100°C the cooling rate is kept to approximately a decrease of 1 degree per minute. This will make the last stage of the cooling take approximately 21 minutes. This is to check the durability of the bottles.
- **Fast Exhaust:** The steam is exhausted out of the chamber at a fast rate until pressure decreases to ambient pressure.
- **Drying:** N/A
- **Ending:** The system checks that End temperature and End pressure have been reached, and then releases the door.

5.15 Program 15: Durham

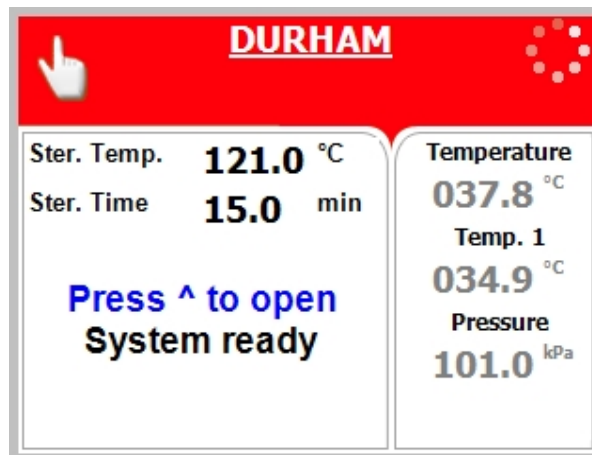

For liquids when the manufacturer recommends autoclaving at temperatures of 121°C (250°F) for 15 minutes.



Cautions!

Both PT100 temperature sensors must be inside the bottles.
For proper sterilization, fill the bottles with approximately the same amount of liquid.

Nominal parameters default settings

- Sterilization temperature: 121°C (250°F).
- Sterilization time: 15 minutes.

Operations sequence:

- **(PV, pre-vacuum models only) Pulse low/Pulse high:** at one pulse it will build vacuum down to 25 kPa.
- **Heating:** Steam enters the chamber and heats it up until the sterilization temperature is reached.
- **Sterilization:** Sterilization temperature is maintained constant during the sterilization time.
- **Slow Exhaust:** Steam is exhausted from the chamber at a slow rate, until chamber temperature reaches 105°C.
- **Cooling:** Forced cooling to the required end temperature, chamber pressure remains at approx. 140kPa, and the cooling valve is opened.
- **Fast Exhaust:** The steam is exhausted out of the chamber at a fast rate until pressure decreases to ambient pressure.
- **Drying:** N/A
- **Ending:** The system checks that End temperature and End pressure have been reached, and then releases the door.

6. Checking and Changing Parameters and Other Data

Bacsoft control panel allows changing parameters of the cycle and of the system, exporting various data to, and importing from, a USB device or to the printer, and some other options.

Cycle parameters are changeable for Custom programs only (see Duplicate cycles), with the exception of the Temperature sensors, Displayed inputs, and Dry Time.

6.1 Browsing through the menus

Now you will learn how to browse through the folders. When you read the Directories and subdirectories chapter with links to specific menus, you will need to know how to browse through the folders using the autoclave control panel. Below is the instruction.

Login as User (see 7.4). The Main menu screen appears. To browse through the menus:

1. Press the Up and Down keys to scroll through the menus.
2. Press the Start/Stop key to enter the next screen (i.e. to get one level down).
3. Repeat steps 1 and 2 to enter the next screen until you get to required screen.

Below are the example screens for the following menu: Cycle Parameters\ Drying\ Dry Time:

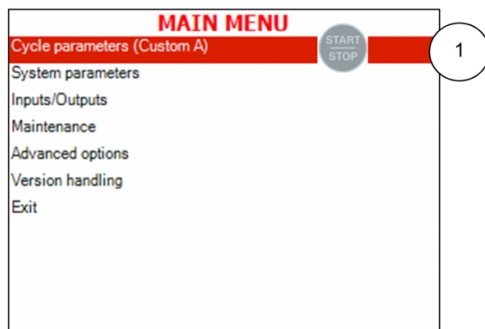

Login as Technician (see 1.4). The Main menu screen appears.
Press the Start/Stop key to enter the Cycle parameters menu.

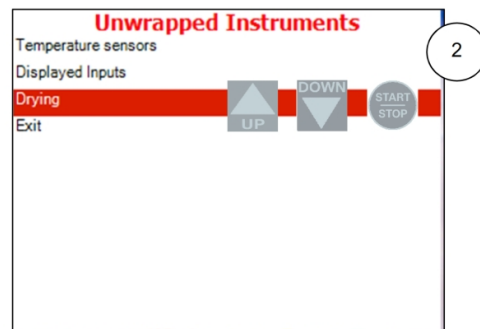

Press the Up and Down keys to scroll through the menus until you get to Drying, then press the Start/Stop key to enter the Drying menu.

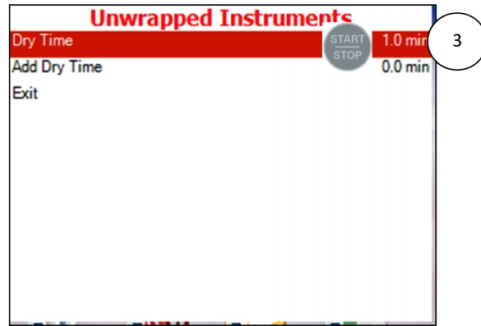

Press the Start/Stop key again to enter the Dry Time menu.

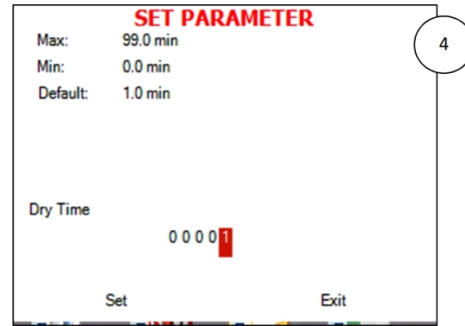

Now you have reached the required screen: Changing the dry time parameter. The path is: **Cycle parameters\Drying\Dry Time.**

Note: To exit every screen and to return to the previous screen (to get one level up):

- move the cursor to Exit by pressing the UP or DOWN keys and then press the Start/Stop key.
- or -
- press the UP and DOWN keys simultaneously.

In the next chapter you will see how to change the required parameter as desired.

6.2 Changing a Parameter

You have browsed through the menus and reached the parameter changing screen as explained above. Now you can change the required parameter as desired. To do so:

1. Enter the required value as follows:
 - Press the Up and Down keys to change the value of the digit.
 - Press the Start/Stop key to move the cursor to the next digit to the left.
2. When finished, press the Start/Stop key repeatedly until you move the cursor to Set.
3. Press the Up or Down key to confirm the new value and to exit the parameter changing screen.

Below is the typical parameter changing screen:

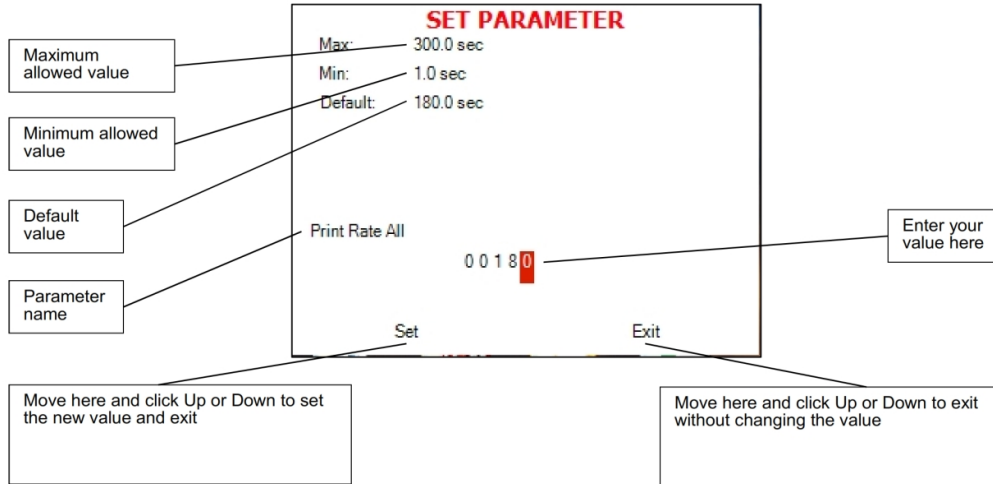

Note: Please note the maximum and minimum values for this parameter shown on the screen. Your value must be within these boundaries.
Below is the example of changing the Dry time parameter on the screen used in the previous section:

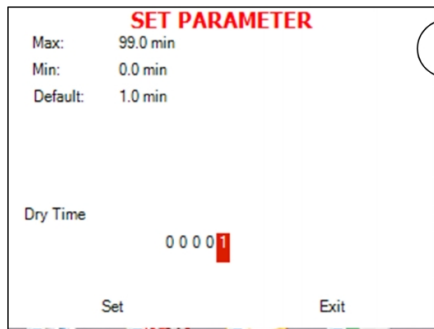

Browse to Changing dry time screen as explained in the previous chapter

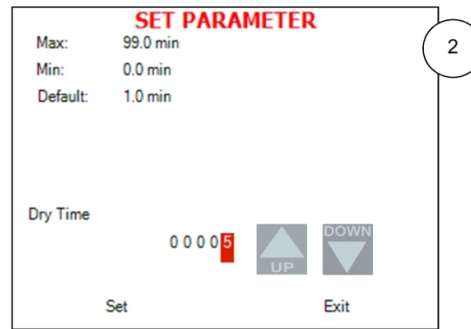

Use Up and Down keys to change the value of the digit

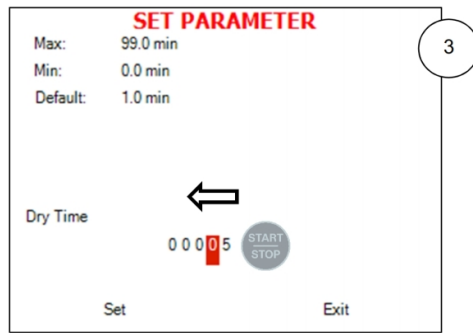

Press the Start/Stop key to move the cursor to the next digit to the left.

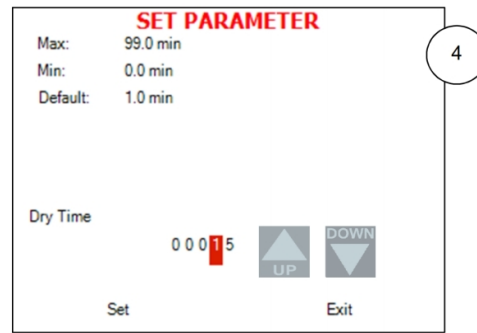

Press the Up and Down keys to change the value of the digit

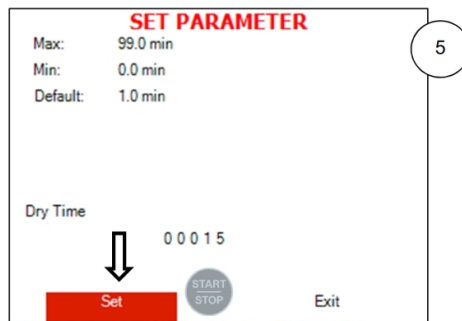

When finished, press the Start/Stop key repeatedly until you move the cursor to Set.

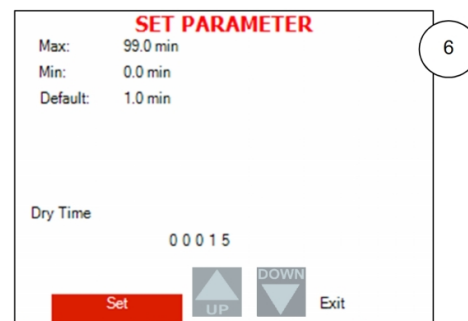

Press the Up or Down key to confirm the new value and to exit the parameter changing screen.

Note: To exit every screen and to return to the previous screen:

- move the cursor to Exit by pressing the UP or DOWN keys and then press the Start/Stop key
- or -
- press the UP and DOWN keys simultaneously

6.3 Quick options screen

When the autoclave is on and no cycle is running, press Up and Down keys simultaneously to enter the Quick options screen. Most of the options require login, and their availability depends on user authority (user, or technician). Login command is the last line on this screen. Quick options are options available without login.

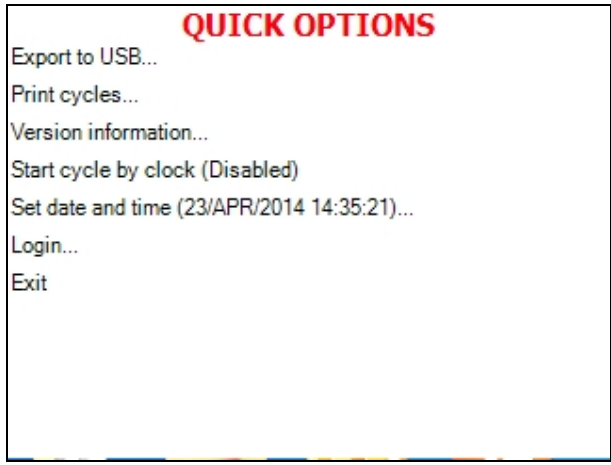

Below you can find instructions how to login and enter the Main menu. Section 7.1 above explains how to browse through the menus; section 7.2 explains how to change a parameter. Below is the explanation of some Quick Options.

6.3.1 Version Information

This directory allows viewing information of the current, factory default, and previous software versions.

1. Enter the Version information screen.

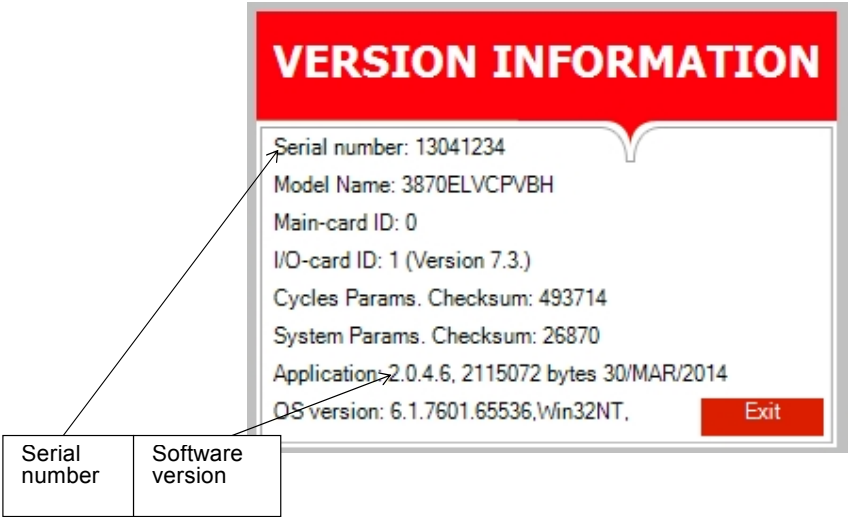

6.3.2 Start cycle by clock

This subdirectory enables the operator to start the cycle at the time set by this parameter.

1. Enter the Start cycle by clock screen. The following screen will appear:



On the Start cycle by clock screen, the time is displayed in the form "HH:MM". The hour range is 24 hours (i.e. from "0" to "24").

Setting the time to start the cycle

1. Move the cursor to the Time field.
2. Set the required time .

Enabling the Start Cycle by Clock

1. Set the starting time .
2. Move the cursor to Enabled. Press Up or Down key to enable starting cycle by clock.



1. Exit the Enabling the Start Cycle by Clock. The start cycle by clock icon appears on the display:

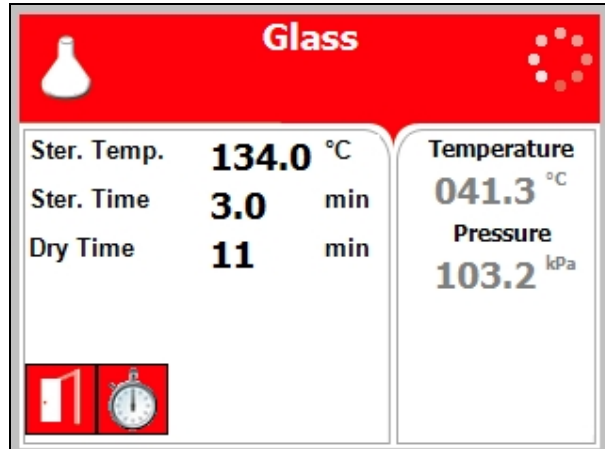

Disabling the START CYCLE BY CLOCK

2. On the Start Cycle by Clock screen, move the cursor to Disabled. Press Up or Down key to disable Starting cycle by clock.
3. Exit the Enabling the Start Cycle by Clock.

6.3.3 Set date and time

This subdirectory enables the operator to set date and time.

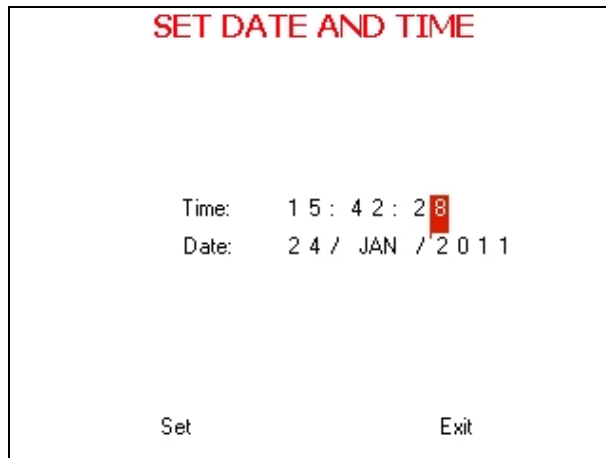

On the Set date and time screen, the time is displayed in the upper row in the form "HH:MM:SS". The hour range is 24 hour (i.e. from "0" to "24"). The date is displayed in the lower row in the form "DD: MMM: YYYY".

1. Set time and date
2. Exit the Set date and time screen. The following screen will appear:



Caution!

After setting time and date, turn the autoclave off and then on again.

6.4 Logging in and entering the Main menu

Below you can find instructions how to login and enter the Main menu. Section 7.1 above explains how to browse through the menus, section 7.2 explains how to change a parameter.

When the autoclave is on and no cycle is running, press the up and down keys simultaneously to enter the *Quick Options* screen (see 7.3). On this screen you can either proceed to login (see below) or choose one of the quick options available without login. To login as user:

1. On the Quick Options screen, choose login.

Select user screen appears.



2. Choose User, then press the Start/Stop key to enter. The following screen will appear:

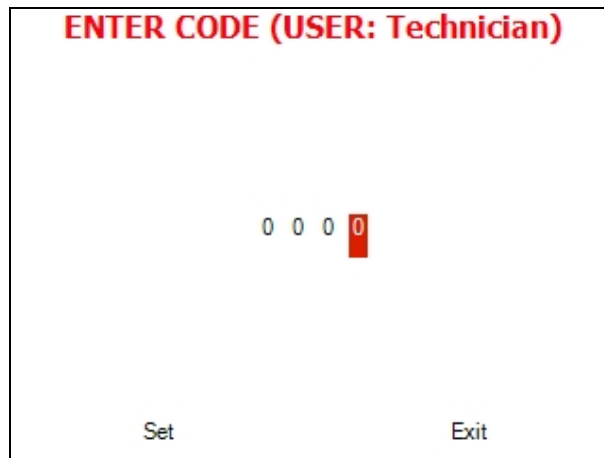

0000 is displayed on the screen with the cursor flashing on the right digit.

- Set the code to 0001. You will get to the Main menu.

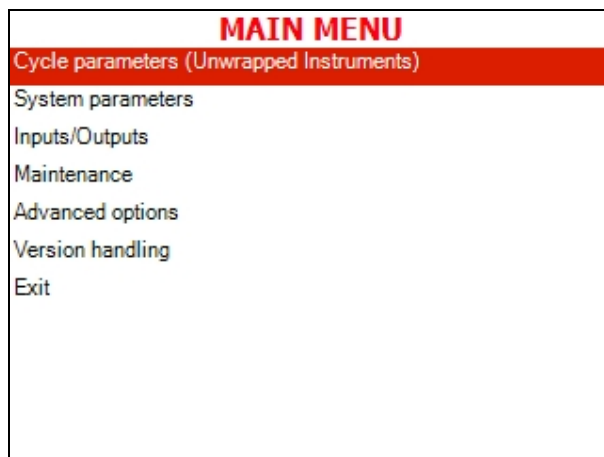

Below is the list and the explanation of some options available to user on the Main Menu.

6.5 Changing parameters

Bacsoft control panel provides an interface that consists of control screens available through an easy scrollable menu tree.

To learn how to scroll through the menus, change the parameters, and perform some other functions using our three-button keypad, see 7.1 and 7.2.

Below is the typical parameter changing screen:

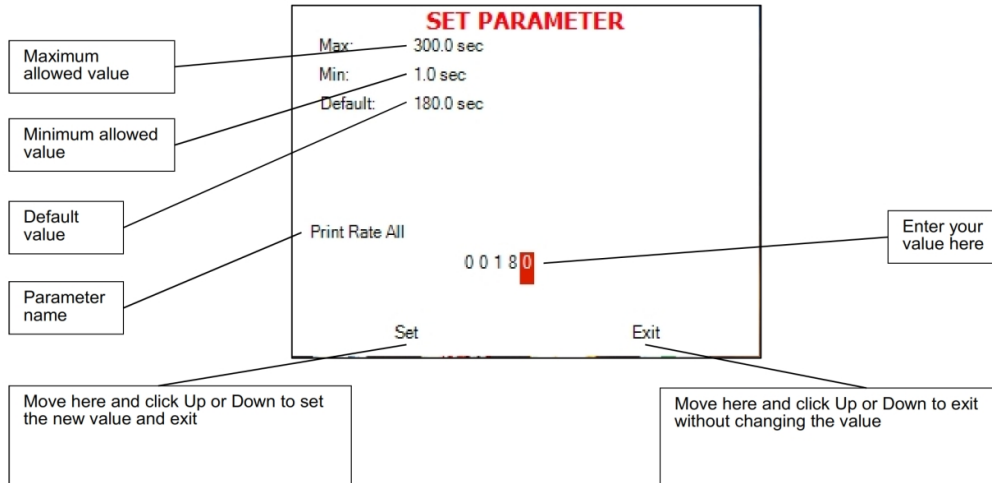

6.6 System Parameters

This menu is listing the system parameters that are the same for all cycles. Browse to the following folder:

Main menu\System parameters

You will see the following screen:

SYSTEM PARAMETERS	
Print Rate All	180.0 sec
Print Rate Sterilization	60.0 sec
Screen Saver	90.0 min
Pressure Calibration High	300.0 kPa
Pressure Calibration Low	25.0 kPa
Temperature Calibration High	130.0 °C
Temperature Calibration Low	60.0 °C
Cycle Print Gap	2.0
Exit	

6.6.1 Screen Saver

In this menu you can define the screensaver delay time, i. e. how long the keyboard will be untouched before the screensaver activates.

Browse to the following folder:

System parameters\Screen Saver

Change the parameter as desired.

6.7 Maintenance

Maintenance procedures provided by *Bacsoft* software allow you additional tests and USB input/output options.

Browse to the following folder:

Main menu\Maintenance

You will see the following screen listing the maintenance options:

MAINTENANCE	
Export gain offset to USB	
Import gain and offset from USB	
Reset atmospheric pressure (103.6 kPa)	
Test RTC	
Printer test	
Print all gain and offset	
Exit	

Below is the instruction for autoclave's maintenance menu.

6.7.1 **Reset atmospheric pressure**

In this menu you can reset the atmospheric pressure value. To do so:

1. Browse to the following folder:

Maintenance\Reset atmospheric pressure

The following screen will appear:



2. Leave the door open for 2 minutes at least. Ambient temperature should be less than 45°C.

Note: Please reset the atmospheric pressure when you install the autoclave for the first time, and each time you relocate or calibrate the autoclave.

6.7.2 **Printer test**

I

In this menu you can check the normal function of the printer. The printer will print the list of errors.

Browse to the following folder:

Maintenance\Printer test

The following screen will appear to confirm that the test has been done.



See the printout shown in the Printer handling chapter of this manual.

6.8 Cycle parameters

The Cycle parameters menu includes parameters of a specific sterilization program (cycle). Browse to the following folder:

Main menu\Cycle parameters

You will see the following screen listing the cycle parameters:

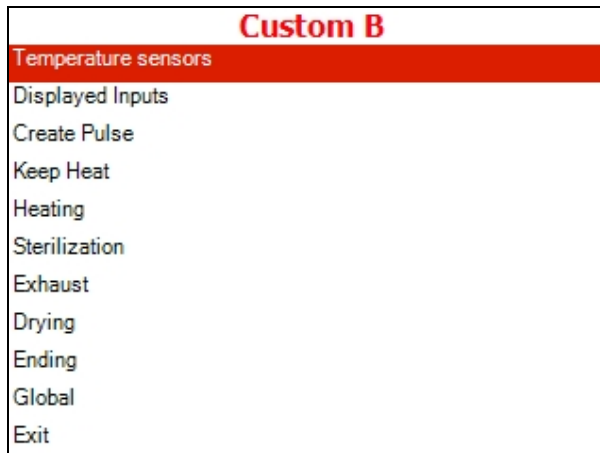

Note: For all the standard sterilization cycles, and for Bowie and Dick test, the only changeable cycle parameter is dry time (you will not see other parameters on your screen). For the custom cycles created by duplication, and for the Warm Up cycle, more options are changeable. Operator is not allowed to create custom cycles; only authorized technician can do this.

6.8.1 Dry Time

This parameter defines duration of the drying stage for the cycle.

1. Browse to the following folder:

Cycle parameters\Drying\Dry Time

2. Change the parameter as desired.

Drying stage is divided into two stages. For each stage you can set the total time, on time and off time. So during the Dry First Stage, the heating elements are on for the time set in Dry Heat On 1, then they go off for the time set in Dry Heat Off 1, and then this sequence is repeated during the entire Dry First Stage Time. The same is true for the Dry Second Stage.

6.8.2 **Add Dry Time**

This subdirectory allows you to change the Dry Time parameter for the current cycle.

Browse to the following folder:

Cycle parameters\Drying\Add Dry Time

Change the parameter as desired

7. Screens

7.1 Screens following a complete successfully cycle – "Cycle Ended"

1. System Ready

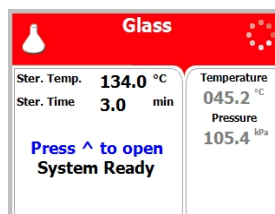

2. Pulse Low (ELPV model only)

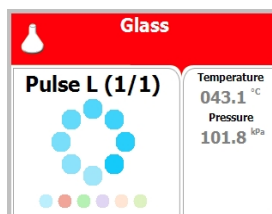

3. Pulse High (1/1) (ELPV model only)

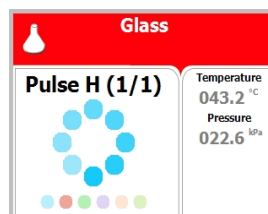

4. Heating

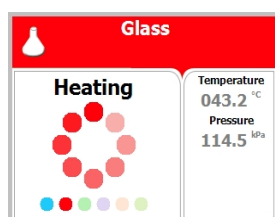

5. Sterilization

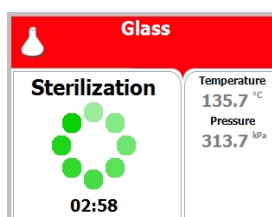

6. Exhaust

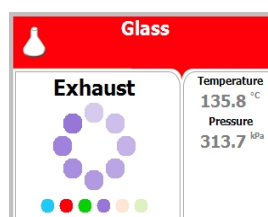

7. Drying (ELPV model only)

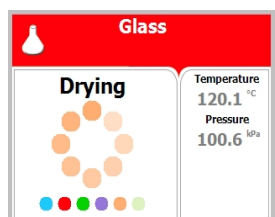

8. Ending

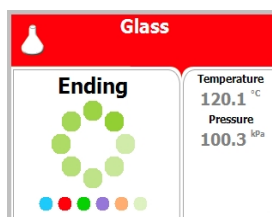

9. Cycle Ended

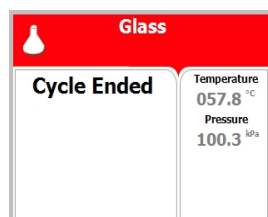

7.2 Screens following aborted cycles after complete sterilization stage

The sterilization phase ended successfully – cycle ended and the reason of failure is displayed

For example the next two scenarios:

7.2.1 Canceled by user after complete sterilization stage

The cycle ended successfully, the reason for aborted cycle is displayed.

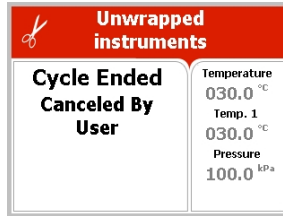

7.2.2 Pressure Time Error Failure occurrence after complete sterilization stage

The cycle ended successfully, the reason of failure is displayed.

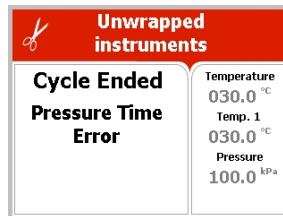

7.3 Screens following a fail cycle:

In this case, the display becomes yellow, a warning sign  and the reason of failure will be displayed.

For example, the next two scenarios:

7.3.1 Failure according to Pressure Time Error



7.3.2 Failure according to Cancellation by user before complete sterilization stage

When "Cycle Failed" appears on the screen, the user shall press **START/STOP** key in order to delete the "Cycle Failed" message

An example for all displayed warnings according to Cycle Failed:

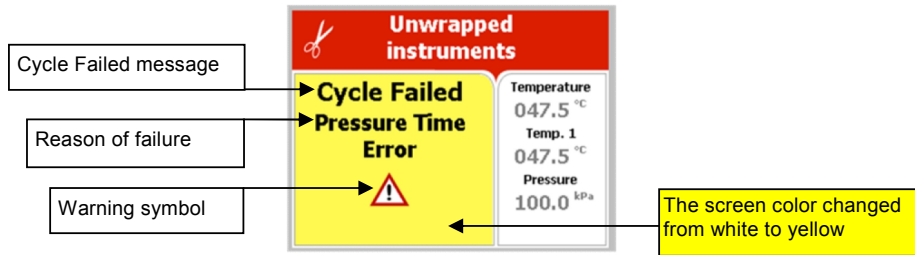

8. Printer

8.1 Printer Output

The printing is on thermal paper with 24 characters per line and contains the following information:

- Date:
- Time:
- Ser. Num:
- Model:
- Version:
- Cycle Num:
- Cycle:
- Dry Time:
- Ster Temp:
- Ster Time:

When the sterilization cycle begins the printer starts printing the above data.

After the preliminary printing, the autoclave starts performing the sequence of operations of the cycle. The measured values of temperature and pressure are printed at fixed time intervals, according to the phase of the process, as shown in the table on the next page.

The data is printed from the bottom up, beginning with the date and ending with "Cycle Ended". For an aborted cycle, "Cycle Failed" and the Error message are printed (refer to "Displayed Error Messages/Symbols").

For an example of a typical printout, see next page.

PRINTER OUTPUT		DESCRIPTION	
Operator:	_____	To be filled in manually by operator	
Time:	12:14:47	Time sterilization cycle ended	
Cycle Ended			
00:24:43	101.3	099.7	Cycle finished time
E 00:23:43	107.0	107.4	The time, temperature and pressure during exhaust

E 00:22:08	134.5	311.9	The time, temperature and pressure during exhaust
CLK 2:	12:12:10:00		
CLK 1:	12:12:10:00		
S 00:22:07	134.5	311.6	The time, temperature and pressure during sterilization
S 00:22:06	134.5	311.6	The time, temperature and pressure during sterilization
S 00:21:06	134.6	311.0	The time, temperature and pressure during sterilization
S 00:20:06	134.5	310.1	The time, temperature and pressure during sterilization
S 00:19:06	134.8	311.1	The time, temperature and pressure during sterilization
S 00:18:06	134.5	315.8	The time, temperature and pressure during sterilization
CLK 2:	12:08:08:00		
CLK 1:	12:08:08:00		
H 00:18:04	134.4	315.1	The time, temperature and pressure during heating
H 00:16:35	128.9	268.4	The time, temperature and pressure during heating
H 00:13:35	116.3	180.9	The time, temperature and pressure during heating
A 00:11:04	107.0	120.9	The time, temperature and pressure during Air removal
A 00:10:22	115.1	180.4	The time, temperature and pressure during Air removal
A 00:10:00	113.7	170.5	The time, temperature and pressure during Air removal
A 00:07:00	098.7	101.5	The time, temperature and pressure during Air removal
A 00:06:45	097.6	101.4	The time, temperature and pressure during Air removal
A 00:03:45	080.2	099.4	The time, temperature and pressure during Air removal
A 00:00:45	053.7	099.4	The time, temperature and pressure during Air removal
A 00:00:04	046.5	100.0	The time, temperature and pressure during Air removal

TIME	°C	kPa	
Ster Time:	4.0min		Sterilization time for selected program
Ster Temp:	134.0°C		Sterilization temperature in chamber for selected program
Cycle:	Unwrapped instru		Cycle name
Cycle Num:	000001		Cycle number
Version:	7.0.00.00		Software version A.B.CC.DD = 7.0.00.00 A: Door Type: Single motor = 7 B: Vacuum Type = 0 C: Total number of Input/Output functionality that are not as default = 00 D: Total number of parameters values that are not as default = 00
Model:	3870ELVC		Model name
Ser. Num:	0000000000001		Model Serial number
Time:	11:50:05		Time sterilization cycle started
Date:	9/FEB/2010		Date sterilization cycle started

Time:	08:51:39		Time of turning on
Date:	9/FEB/2010		Date of turning on
POWER ON			The device is turned on
Time:	00:00:00		Time of turning off
Date:	9/FEB/2010		Date of turning off
POWER OFF			The device is turned off

Legend			
A	Air removal stage (Steam flash)	E	Exhaust stage
H	Heating stage		
S	Sterilization stage	CLK 1	Real Time Clock
C	Cooling stage (for ELVC only)	CLK 2	Software clock
D	Drying Stage (ELPV Model only)		

8.2 Printer Handling

8.2.1 Maintenance

Wipe off the soiling on the printer surface with a dry soft cloth with a weak neutral detergent. After that, wipe the printer with a dry cloth.

8.2.2 Setting paper

PLUS II Front view

- 1-Paper mouth
- 2-STATUS Led
- 3-OPEN key (for paper roll compartment opening)
- 4-FEED key
- 5-Paper roll compartment
- 6-Paper end sensor

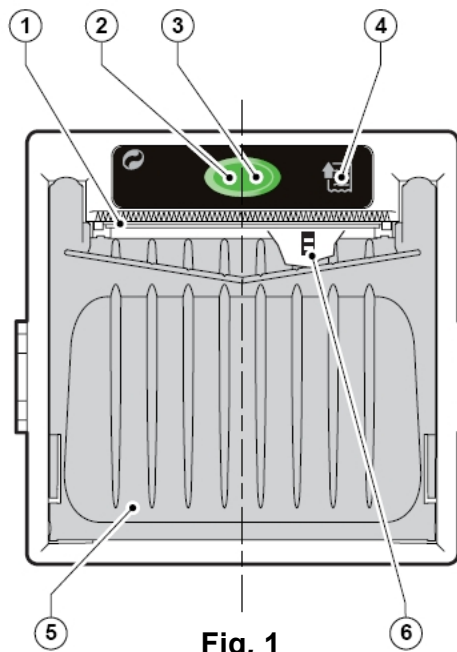

1. Open the printer's cover door (1) by pulling it up (see Fig. 2).

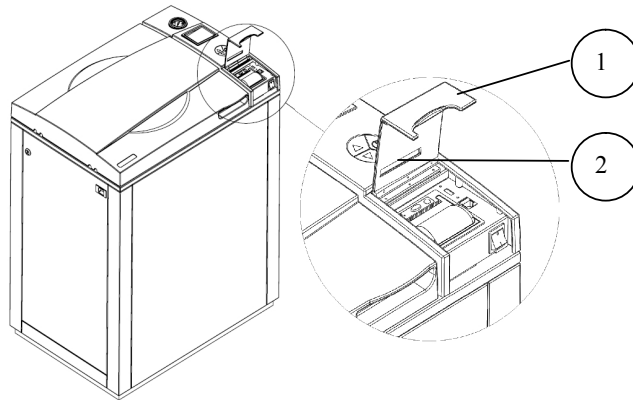

Fig. 2

2. Press the OPEN key to open the printer cover as shown (see Fig. 3/1). Handle the paper cutter carefully not to cut your hand.
3. Place the paper roll making sure it unrolls in the proper direction as shown (see Fig. 3/2).
4. Take out the paper and re-close the cover as shown (see Fig. 3/3) the printer cover is locked.
5. Tear off the exceeding paper using the jagged edge (see Fig. 3/4).

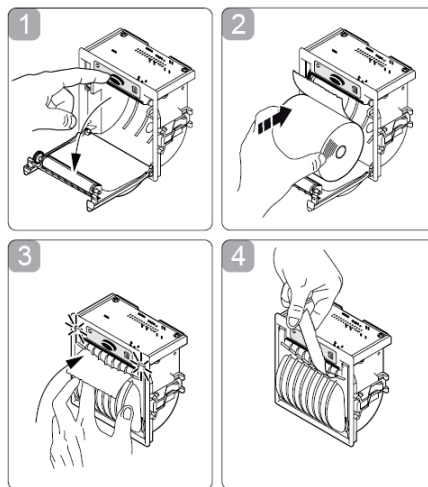

Fig. 3

6. Close the printer's cover door (1) by pulling it down, with the tip end of the paper emerging from the slot (2) (see Fig. 2).

8.2.3 Treating the thermal papers:

- Store the papers in a dry, cool and dark place.
- Do not rub the papers with hard substance.
- Keep the papers away from organic solvent.



Cautions!

Never disassemble the printer. Failure to follow this instruction may cause overheating or burning of the printer or the AC adapter. Or an electric shock, which may lead to fires or accidents.

Never use the printer in a place of extreme humidity or any place where it can possibly be splashed by any liquids. If any liquids get into the printer, it could lead to fire, electric shock, or other serious accidents.

Never touch the thermal head immediately after printing because it becomes very hot. Make sure that the thermal head is cool before setting papers or cleaning the thermal head.

Power OFF the printer in any of the following cases:

- The printer does not recover from an error.
- Smoke, strange noise or smells erupt from the printer.
- A piece of metal or any liquid touches the internal parts or slot of the printer.

9. Preparation before Sterilization

The purpose of packaging and wrapping of items for sterilization is to provide an effective barrier against sources of potential contamination in order to maintain sterility and to permit aseptic removal of the contents of the pack. Packaging and wrapping materials should permit the removal of air from the pack, penetration of the sterilizing water vapor into the pack and removal of the sterilizing vapor.

The basic principle determining the size, mass and contents of instrument and hollowware packs is that the contents are sterile and dry immediately on completion of the drying cycle and removal of the pack from the sterilizer chamber.

Instruments to be sterilized must be clean, free from any residual matter, such as debris, blood, pads or any other material. Such substances may cause damage to the contents being sterilized and to the sterilizer.

1. Immediately after use, clean instruments thoroughly to dispose of any residue.
2. Follow the instrument manufacturer instructions.
3. It is recommended to wash instruments with an ultrasonic cleaner, using detergent and mineral-free water.
4. Launder textile wraps prior to reuse.
5. After cleaning, rinse instruments for 30 seconds. (Follow manufacturer's instructions on the use of products for cleaning and lubricating instruments after using the ultrasonic cleaner).
6. Materials, including materials used for inner wraps, shall be compatible with the item being packed and the sterilizing method selected.
7. Use single-use wraps once only and discard after use.
8. If the unit is equipped with a printer, verify if a new roll of paper is necessary.

9.1 Instruments

1. Before placing an instrument onto the sterilizer baskets, ensure that instruments that are not constructed of the same metal (stainless steel, carbon steel, etc.) are separated and placed in a different place.
2. Place empty containers upside down to prevent accumulation of water.
3. In case carbon steel instruments are placed in stainless steel baskets, the baskets should be lined with a towel or paper wrap before placing the instruments on the baskets. There should be no direct contact between the carbon steel and the stainless steel baskets.
4. All instruments must be sterilized in an open position.
5. Place a sterilization indicator strip in each basket.
6. Place instruments with ratchets opened and unlocked or clipped on the first ratchet position.

7. Disassemble or sufficiently loosen multiple-part instruments prior to packaging to permit the sterilizing agent to come into contact with all parts of the instrument.
8. Tilt on edge items prone to entrap air and moisture, e.g. hollowware, so that only minimal resistance to removal of air, the passage of steam and condensate will be met.
9. Once a week, use a biological spore test indicator in any load to make sure sterilization is performed.
10. Make sure that all instruments remain apart during the sterilization cycle.
11. Load the basket loosely to capacity.

9.2 Liquids

1. Use only heat- proof glass containers, filled to 2/3 capacity.
2. For Slow exhaust cooling (without air) the glass container should be covered but unsealed.
3. Place the two temperature sensors into two separate liquid containers. These are used to control the program temperature and ensure the safety of the operating cycle.

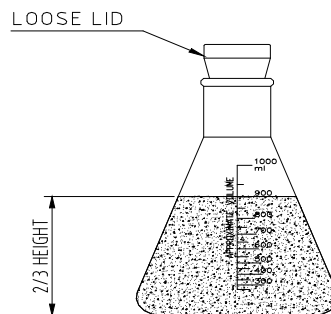

9.3 Loading

The loading of goods and instruments is done by means of two stacked baskets. The baskets are provided with handles for the convenience of the operator.

There are 2 types of baskets:

1. Baskets that are fully perforated.
2. Baskets that are not perforated except one row of holes adjacent to the basket's top. These baskets are intended for waste cycles, to avoid clogging of the vessel's drainage pipe by overflowing liquids.

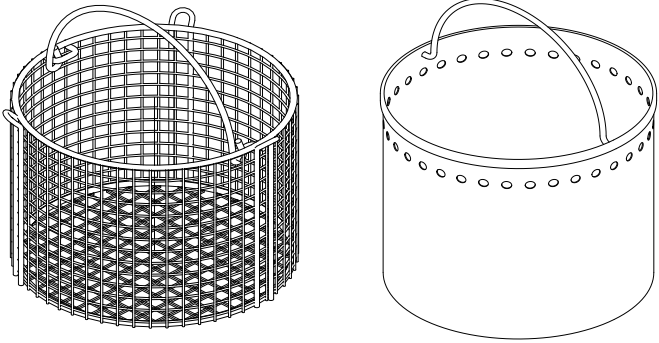

10. Operation

10.1 Draining and filling the water reservoir (WR only, outside and inside reservoir configurations).

10.1.1 Draining



Caution!

Before starting, Make sure that the electric cord is disconnected and there is no pressure in the autoclave.

The drain valve is located on the bottom of the water reservoir (See **REAR VIEW (WR CONFIGURATION OUTSIDE RESERVOIR)**). The function of the drain valve is to drain the water reservoir.

To drain the reservoir into a bucket:

1. Open the drain valve.
2. Fully drain the reservoir.
3. Close the drain valve.

Drain the water from the mineral free water reservoir once a week, and refill with fresh mineral-free water or distilled water

10.1.2 Filling

1. Connect the electric cord to power source.
2. **For the outside reservoir:** Remove the water reservoir cover (See Rear view, WR Configuration). Pour distilled water into the reservoir until it reaches the cooling coil (see the figure below, 1). The water quantity is approx. 28 liters.

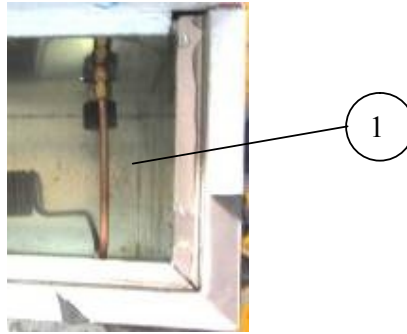

For the inside reservoir: Pour distilled water through a water inlet (1) near the chamber into the reservoir using a carafe (2) so that the glass tube fills 4-5 cm below its upper end as shown by the yellow float (3). The water quantity is approx. 16 liters.

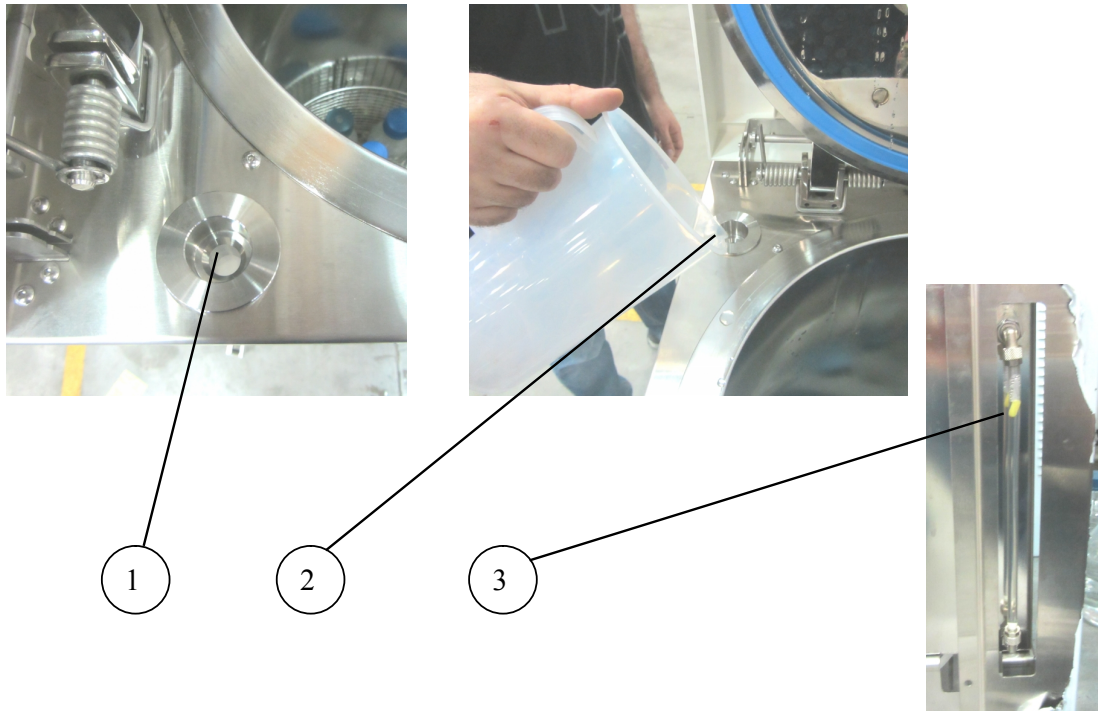

Caution! Use only water having the characteristics as per table in sec 4. Tap water may clog the system. A clogged system causes increase of pressure, which prevent temperature from rising.

4. Turn on the main power switch.



Caution!

Under no circumstance should water be filled above the cooling coil.

10.2 Turning on the autoclave

- To start the system, turn on the main switch (1), located under the printer cover.

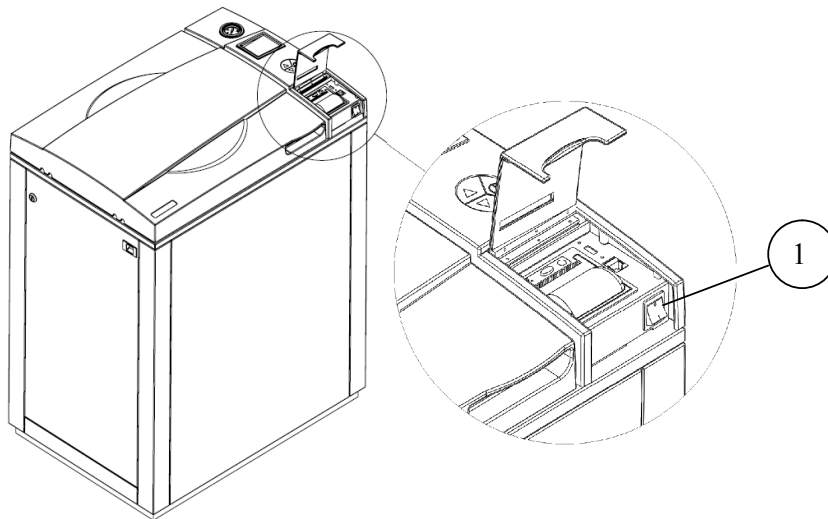

The door is equipped with an electrical cylinder. This electrical cylinder performs the automatic opening and closing of the door.

10.3 Opening the door

In order to open the door, follow the next steps:

When the door is closed the screen below will be displayed:

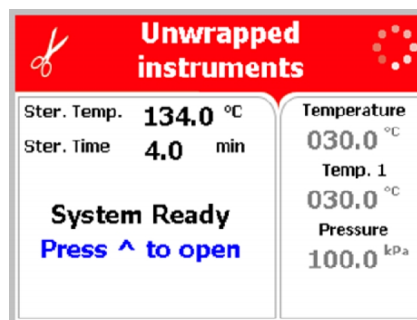



Press the **UP** key in order to open the door
The following screen will be displayed:

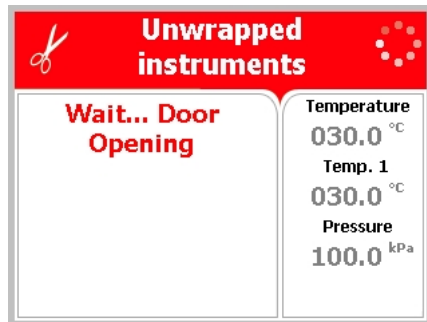

If the door has opened successfully, the following screen will be displayed:

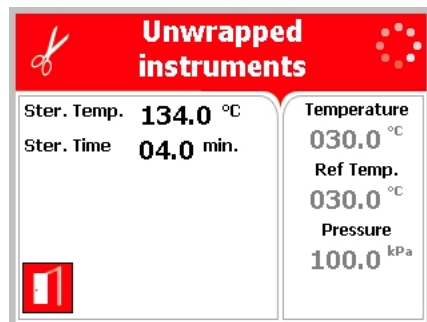

10.4 Loading

- Load the autoclave properly according to instructions in sec. 9. PREPARATION BEFORE STERILIZATION.
- Select the program.
- **UP** key: next program.
- **DOWN** key: previous program.
- Verify that you chose the required program.

10.5 Closing and locking the door

In order to close the door, follow the following steps:
When the door is open, the screen below will be displayed:

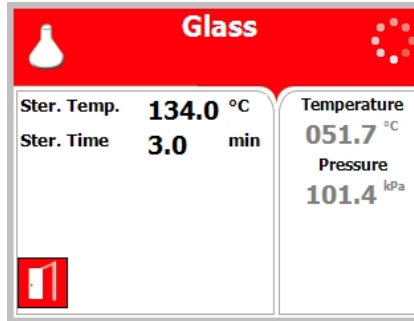

1. Close the door:





Warning!

In order to close and lock the door push the door to the wall of the autoclave chamber (for about 10 seconds) until the "System Ready" message appears as shown below!

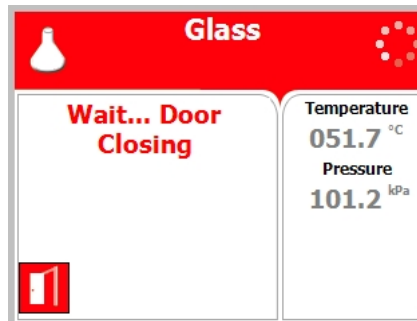

While the door is locking the following screen will be displayed:



When the door is properly locked, open door symbol  will be replaced by the "System Ready" message as shown below:

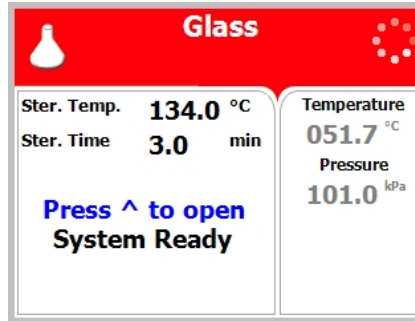

10.6 Starting the cycle

1. For the first cycle, fill the mineral -free water reservoir. If "Supplied Distilled Water Error" message appears between the cycles, add water to the reservoir until the message disappears. Do not fill the reservoir completely!
2. Start the cycle by pressing the START/STOP key. If your autoclave supports *CFR 21 part 11* standard, perform the following procedure:

SELECT USER screen will be displayed:

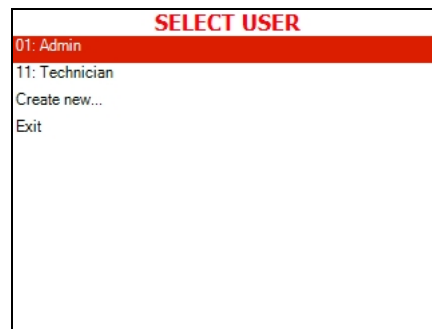

1. Enter the Enter Code screen by moving the cursor to your username (Use **Up** and **Down** keys) and pressing **START/STOP** key. The following screen will be displayed:

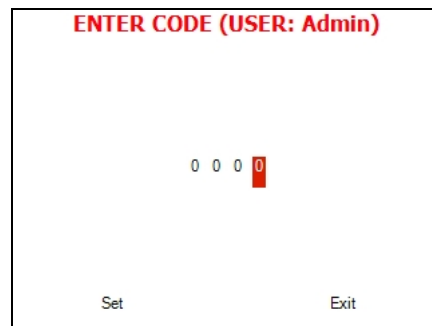

2. 0000 is displayed on the screen with the cursor blinking on the right digit.
3. To increase or decrease the digits, press the **UP** or **DOWN** keys.
4. Set your password, then move the cursor to **Set** by pressing the **START/STOP** key.
5. When **Set** is blinking, press the **UP** or **DOWN** keys to return to the program screen.

10.7 Unloading

When the cycle ended successfully (including pressing the **START/STOP** key, or any failure, after completing the sterilization stage) message "Cycle Ended" (and the relevant failure message, if applicable) is displayed on the screen.

- Verify that there is no pressure in the chamber, according to the reading on the display. Only then you may open the door.
- Open the autoclave. (see 10.3 Opening the door)



Warning!

To avoid sever injuries from hot steam when opening the door:

- **It is strictly forbidden to lean on the autoclave.**
 - **It is strictly forbidden to place your hand or any part of your body over the door.**
 - **Since the autoclave is defined as a bio-hazard autoclave, a failed cycle may leave un-sterilized waste in the chamber. Therefore failed cycle will be followed by a slow exhaust and the door will remain locked. To enable opening the door perform a new cycle. The door can be opened only after a successful cycle.**
- Wear heat-resistant gloves or use the tray handle to remove the load from the autoclave
 - On completion of the cycle, the load shall be visual inspected to ascertain that the load is dry, and that the colour of the sterilization indicators turned to the required colour.

10.8 Stopping the process and cancelling the **ERROR** message

- It is possible to stop the program while the autoclave is operating. Pressing the **START/STOP** key at any stage of the process stops the operation. If the cycle was aborted before completing the sterilization stage, it will leave the load unsterilized.

- At the end of the aborted process (before completing the sterilization stage), "**Cycle Failed**" message, error message and a warning symbol are displayed on the screen. Refer to "Displayed Error Messages/Symbols".
- Pressing the **START/STOP** key cancels the displayed message and enables opening the door.
If the door is not opened, the vacuum pump will stop automatically after 30 minutes (ELPV model only).



Warning!

The load has not completed a sterilization cycle, therefore it is not sterile. Handle it as contaminated load.

10.9 Start Cycle by Clock mode

- This mode enables the operator to define the time of the beginning of the cycle. The maximum possible delay is 24 hours. For further information see **Error! Reference source not found..** Start Cycle by Clock.

10.10 Moving the Autoclave

1. Disconnect the power supply cord.
2. Disconnect the water and drain hoses.
3. Disconnect the compressed air hoses (if applicable).
4. Drain the water from the chamber.

To avoid injuries, Moving the autoclave should be done by using a forklift.



Caution:

Before moving the autoclave, verify that the electrical, air and water connections have been disconnected, and there is no pressure in the chamber.

Do not drop this device!

10.11 Loading and Unloading the Device

10.11.1 Safety

Protective equipment and clothes and other safety instructions should be implemented in accordance with local and national regulations and/or rules!

For proper sterilization - Do not overload the chamber. Only autoclavable products shall be used; please refer to the manufacturer instructions for sterilization of unknown materials or instruments.

10.11.2 Loading

Correct loading of the autoclave is essential to successful sterilizing for several reasons. Efficient air removal from the chamber and the load will permit effective steam penetration and saturation, and allow proper drainage of condensate. Additionally, correct loading will prevent damage to packs and their contents and maximize efficient use of the sterilizer.

For detailed loading instructions, see 9 Preparation before sterilization.

10.11.3 Unloading

On completion of the cycle, take out the load immediately from the sterilizer. Do not remove the load from the basket until its temperature reduces to the room temperature. Let the load cool down in an area without air movement (air conditioning, etc.) and with minimum people passing by to avoid possibility of touching the hot load. Do not touch the hot load since hot load absorbs moisture and, therefore, may absorb bacteria from your hand. Do not transfer hot load to metal shelves for cooling. Perform a visual inspection to ascertain that sterilizing indicators have made the required colour change, and that the load is dry.

The load shall be rejected if:

- a. The package has been compressed.
- b. The package is torn.
- c. The load is suspected to be wet.
- d. The load fell on the floor.
- e. Condensed drops can be detected on the load.



Caution! To avoid injuries use heat resistant gloves while unloading the autoclave.

11. Service and Maintenance

11.1 Preventive Maintenance

The maintenance operations described in this chapter must be fulfilled periodically in order to keep the autoclave in good working condition and to reduce the breakdown time to a minimum.

The user's maintenance personnel, according to the following instructions can easily execute these operations.

The owner of the autoclave is responsible to order an authorized technician to perform the periodical tests and preventive maintenance operations, as specified in the technician manual.

Use only mineral-free water as detailed in sec. 3.11 (water quality).



Warning

Before carrying out any preventive maintenance operation, ensure that the electrical cord is disconnected and there is no pressure in the autoclave.

11.1.1 Daily

Clean the door gasket with a soft cloth. The gasket should be clean and smooth.

11.1.2 Weekly

3. Remove the baskets (if applicable). Clean the chamber and baskets with a cleaning agent & water and with a cloth sponge. You may use diluted Chamber Brite™ solution as cleaning agent. To prepare this solution, pour one bag of Chamber Brite™ into 3/4 – 1 liter of warm mineral-free water. Immediately after cleaning, rinse the baskets and the chamber's interior with water to avoid stains on the metal.



Caution

Do not use steel wool or steel brush as this can damage the chamber!

4. Drain out the vessel and clean the electrode with a soft cloth.
5. Drain the water from the mineral -free water reservoir once a week, and refill with fresh mineral-free water or distilled water (see 10.1). If "Supplied Distilled Water Error" message appears between the cycles, add water to the reservoir until the message disappears. Do not fill the reservoir completely!
6. Put a few drops of oil on the two door pins and door tightening bolts.

7. Clean outer parts of the autoclave with a soft cloth.

11.1.3 Periodically by Qualified Technician

For the BH – bio-hazard models, every 1 month, or if the cycle fails because of "low-heat", sterilize and clean the bio-hazard filter.

2. For the BH – bio-hazard models, every 100 cycles replace the bio-hazard filter.
 1. Every 6 months replace the air filter, (if installed) (to be done by an authorized technician).
 2. Once a year check and tighten the piping joints to avoid leakage (to be done by an authorized technician).
 1. Checking the water reservoir, piping, plastic parts and electric wires.
 3. Once a year check and tighten all screw connections in the control box, heaters, valves and instrumentation (to be done by an authorized technician).

11.1.4 Periodical Tests

1. Once every month activate the safety valve (see below).

11.2 Checking the Safety Valve

The safety valve is located on the rear side of the autoclave

In order to prevent the safety valve from a blockage, operate it once a month.

11.2.1 PED-approved type safety valve

Operate the sterilization cycle according to the manual.

Allow a pressure of approximately 200 kPa (29 psi) to build up in the chamber.

Turn the safety valve pressure-regulating nut clockwise for 2 seconds. Be careful not to burn your hands.

Return the nut to its original position.

Press the **STOP/STOP** key to interrupt the operation, and exhaust steam from chamber.

Wait until the pressure decreases to zero, only then can the door be opened.



Attention:

Use protective gloves in order not to burn your hands with the hot steam.

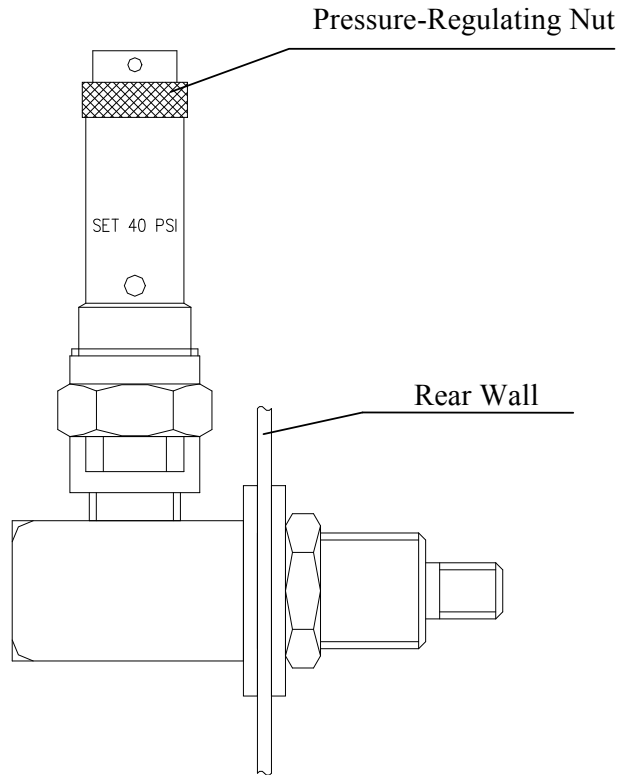

11.2.2 ASME-approved type safety valve

Operate the sterilization cycle according to the manual.

Allow a pressure of approximately 200 kPa (29-psi) to build up in the chamber.

Operate the safety valve by pulling the ring of the safety valve using a tool, i.e. screwdriver, hook etc and lift the safety valve ring for 2 seconds. Be careful not to burn your hands.

Press the **STOP/STOP** key to interrupt the operation, and exhaust steam from chamber.

Wait until pressure goes down to zero, only then can the door be opened.



Attention:

Use protective gloves in order not to burn your hands with the hot steam.

Safety valve ring

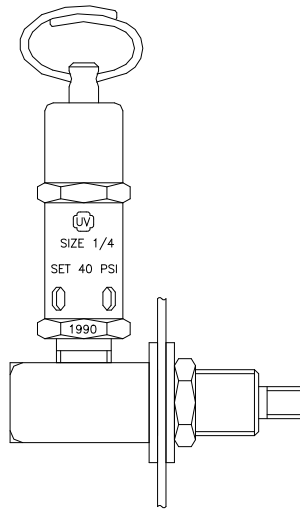

12. Troubleshooting

This troubleshooting chart enables the user to solve minor malfunctions, prior to contacting our service department.

Only technical personnel having proper qualifications and holding technical documentation (including a technician manual) and adequate information are authorized to service the apparatus.

Message / Symbol / Problem	Failure Description	Corrective Action
The machine is not responding	<ol style="list-style-type: none"> 1 The main switch is in 'OFF' position. 2 The power cord is disconnected from the machine or the mains. 3 The circuit breaker has tripped. 	<ol style="list-style-type: none"> 1 Turn the main switch to the 'On' position. (see front view drawing). 2 Make sure the power cord is connected properly to the machine and the mains. (see rear view drawing) 3 Lift the circuit breaker lever.
The printer prints, but nothing is printed on the paper.	<ol style="list-style-type: none"> 1 The Paper roll is not installed in the right way. (see 8.2 Printer handling) 	<ol style="list-style-type: none"> 1 Install the paper roll in the right way. Only one side of the paper is printable. (see 8.2 Printer handling)
The printer does not print.	<ol style="list-style-type: none"> 1 No paper is inserted in the printer. (see 8.2 Printer handling) 2 No obvious reason. 	<ol style="list-style-type: none"> 1 Make sure the paper roll is inserted in the printer. (see 8.2 Printer handling) 2 Switch off the machine and switch it back on for restart
The machine is leaking at the door	<ol style="list-style-type: none"> 1 The door gasket is dirty. (see 11.1.1 Preventive maintenance) 2 The door gasket is damaged. 	<ol style="list-style-type: none"> 1 Clean the door gasket. (see 11.1.1 Preventive maintenance). 2 call for service.
Low Vacuum' is displayed	Message is displayed and FAIL indicator lights if in the	<ol style="list-style-type: none"> 1 Perform a new cycle.

Message / Symbol / Problem	Failure Description	Corrective Action
	air removal stage a vacuum level of 15kPa is not reached during 20minutes after the cycle is started	2 Call the technician. 3 The bio-hazard filter may be clogged. Since the door cannot be opened until a complete successful cycle is completed – call for technical service.
Low Temp	This message is displayed if the temperature drops for more than 1 second below the sterilization temperature during sterilization cycle.	Perform a new cycle.
High Temp	This message is displayed if the temperature raises 7°F (4°C) above sterilization temperature during the sterilization stage for 2 seconds during sterilization cycle.	Perform a new cycle.
High Temp. (Ending)	This message is displayed if the system cannot reach the required temperature, in the chamber, within 10 minutes.	Perform a new cycle.
High Temp. (Cooling)	This message is displayed if the system cannot reach the required temperature, in the cooling stage, within preset time.	Check and fix the city (tap) water supply.
Heat Time Error	This message is displayed if the system cannot reach the required temperature, in the chamber, within the preset time.	Verify that the autoclave is not overloaded.
Heat Time Error (Keep)	This message is displayed if the system cannot reach the required temperature, in the chamber, during the optional "Keep Heat" stage, within the preset time.	Verify that the autoclave is not overloaded.
Low Pressure	This message is displayed if Chamber Pressure drops below the sterilization pressure (134°C = 304 kPa, 121°C =	Perform a new cycle.

Message / Symbol / Problem	Failure Description	Corrective Action
	205 kPa) for 2 seconds during the sterilization stage.	
Low Pressure (Cooling)	This message is displayed if the pressure in chamber does not reach the preset pressure before initiating the cooling stage.	Check and fix the compressed air supply.
High Pressure	This message is displayed if Chamber Pressure raises 4.2 psi-29 kPa above sterilization pressure (134°C = 304 kPa, 121°C = 205 kPa) for 2 seconds during the sterilization stage.	Perform a new cycle.
High Pressure (Ending)	This message is displayed if the system cannot reach atmospheric pressure \pm 10kPa during the ending stage.	Perform a new cycle.
High Pressure (Exhaust)	This message is displayed if the system cannot reach preset pressure within 10 minutes from the beginning of the exhaust stage.	Perform a new cycle.
Pressure Time Error	This message is displayed if the system cannot reach the required pressure conditions in the chamber, after preset time, during the air removal stage.	Verify that the autoclave is not overloaded.
RTC Error - Please Set Current Date and Time	This message is displayed in order to set the date and the time.	Set Current Date And Time. If the problem persists, call the technician.
Time Error	This message is displayed if the real time clock is faulty.	Call the technician.
Door is open (During the cycle)	This message is displayed when the door is open: During the cycle.	Close the door to perform a new cycle.
Canceled By User	This message is displayed after the START/STOP key is pressed and cycle aborted.	Wait until "cycle failed – canceled by user" or "cycle end – canceled by user" is displayed. Perform a new cycle.

Message / Symbol / Problem	Failure Description	Corrective Action
Cycle Failed 	This message and symbol are displayed if an error occurs before sterilization cycle is completed.	Perform a new cycle.
Air Error	This message is displayed at the end of the cycle if the autoclave does not reach the atmospheric pressure after 10 minutes.	Wait until the autoclave reaches the atmospheric pressure and perform a new cycle.
Compressed air supply error	This message is displayed in case of a compressed air supply malfunction.	Check and fix the compressed air supply.
Periodical check time exceeded - Please call for service	The periodical maintenance time has passed.	Call for service.
"Supplied Distilled Water Error"	Mineral free water reservoir empty"	Fill the mineral free water reservoir.
Cycle counter exceeded - Please call for service	Number of cycles, since last periodical maintenance, exceeded the preset number as defined by "cycle counter" parameter.	Call for service.
Power Down	This message is displayed if power down has occurred during the cycle. (this message will print out in the printer after the autoclave will turn on).	Turn on the autoclave and wait until the autoclave is ready (reaches the safe condition) and perform a new cycle.
Supply distilled water error (digital input option)	This message is displayed in case of a mineral free water supply malfunction.	Check and fix the mineral free water supply
Supply water error (digital input option)	This message is displayed in case of a city (tap) water supply malfunction.	Check and fix the city (tap) water supply.
Compressed air supply error	This message is displayed in case of a compressed air supply malfunction.	Check and fix the air supply.

Message / Symbol / Problem	Failure Description	Corrective Action
(digitat input option)		
No Water	This message is displayed if the electrode in the chamber did not sense water within the preset time.	<ol style="list-style-type: none"> 1. check and fix the mineral free water supply. 2. check and clean the water inlet filter. 3. Clean the water level electrode.
Analog Input Error	This message is displayed when any Temperature sensor or Pressure sensor is disconnected or out of range.	Call for service.
Chamber temperature not in range	This message is displayed if the temperature in the chamber is too high or too low from the normal range.	Call for service.
Chamber pressure not in range	This message is displayed if the pressure in the chamber is too high or too low from the normal range.	Call for service.
I/O Card Failed	This message is displayed if I/O card is faulty (both while cycle is running or not).	Call for service.
I/O card is not connected	This message is displayed if I/O card is disconnected (both while cycle is running or not).	Call for service.

13. Baskets and Containers



Container for waste products

High Basket

Low Basket

Type	Stainless steel wire baskets		Stainless steel container for waste products, with vent holes	
Model	Dia. x Height (mm)	Capacity	Dia. x Height (mm)	Capacity
3840	357 x 220	1	366 x 330	1
	357 x 330	1	366 x 220	1
3850	357 x 220	2	366 x 330	1
	357 x 330	1	366 x 220	2
3870	357 x 330	2	366 x 330	2
	357 x 220	3	366 x 220	3

14. Spare Parts List

Description	Cat. No.
Cap for ¼" strainer	FIL175-0027
Strainer element	FIL175-0046
Teflon gasket 4 mm	GAS082-0008

15. Accessories

Description		Cat. No.
Printer, PLUSII-S2B-0004		THE002-0052
Stainless steel wire basket	High	BSK387-0001
	Low	BSK387-0002
Stainless steel container for waste products, with vents holes	High	BSK387-0005
	Low	BSK387-0003