

# Agilent 2100 Bioanalyzer System



2100 Expert Software  
User's Guide



**Agilent Technologies**

# Notices

© Agilent Technologies, Inc. 2000-2020

No part of this manual may be reproduced in any form or by any means (including electronic storage and retrieval or translation into a foreign language) without prior agreement and written consent from Agilent Technologies, Inc. as governed by United States and international copyright laws.

## Document Number

SD-UF0000050 Rev. D.00

## Edition

02/2020

Published in Germany

Agilent Technologies  
Hewlett-Packard-Strasse 8  
76337 Waldbronn

## For Research Use Only

Not for use in diagnostic procedures

## Warranty

**The material contained in this document is provided “as is,” and is subject to being changed, without notice, in future editions. Further, to the maximum extent permitted by applicable law, Agilent disclaims all warranties, either express or implied, with regard to this manual and any information contained herein, including but not limited to the implied warranties of merchantability and fitness for a particular purpose. Agilent shall not be liable for errors or for incidental or consequential damages in connection with the furnishing, use, or performance of this document or of any information contained herein. Should Agilent and the user have a separate written agreement with warranty terms covering the material in this document that conflict with these terms, the warranty terms in the separate agreement shall control.**

## Technology Licenses

The hardware and/or software described in this document are furnished under a license and may be used or copied only in accordance with the terms of such license.

## Restricted Rights Legend

If software is for use in the performance of a U.S. Government prime contract or sub-contract, Software is delivered and licensed as “Commercial computer software” as defined in DFAR 252.227-7014 (June 1995), or as a “commercial item” as defined in FAR 2.101(a) or as “Restricted computer software” as defined in FAR 52.227-19 (June 1987) or any equivalent agency regulation or contract clause. Use, duplication or disclosure of Software is subject to Agilent Technologies’ standard commercial license terms, and non-DOD Departments and Agencies of the U.S. Government will

receive no greater than Restricted Rights as defined in FAR 52.227-19(c)(1-2) (June 1987). U.S. Government users will receive no greater than Limited Rights as defined in FAR 52.227-14 (June 1987) or DFAR 252.227-7015 (b)(2) (November 1995), as applicable in any technical data.

## Safety Notices

### CAUTION

A **CAUTION** notice denotes a hazard. It calls attention to an operating procedure, practice, or the like that, if not correctly performed or adhered to, could result in damage to the product or loss of important data. Do not proceed beyond a **CAUTION** notice until the indicated conditions are fully understood and met.

### WARNING

A **WARNING** notice denotes a hazard. It calls attention to an operating procedure, practice, or the like that, if not correctly performed or adhered to, could result in personal injury or death. Do not proceed beyond a **WARNING** notice until the indicated conditions are fully understood and met.

## In This Guide...

Welcome to the User's Guide for the Agilent 2100 Expert Software. This manual provides beginners and advanced users with information needed to successfully run electrophoretic assays with the 2100 Bioanalyzer system. The 2100 Expert Software allows the control of the 2100 Bioanalyzer instrument (including diagnostic functions) and, in combination with an analysis kit, the acquisition, interpretation and result presentation of data generated during the analysis of DNA, RNA, and proteins.

### **1 Typographic conventions in this Manual**

This chapter shows you how to make efficient use of this manual.

### **2 Quick Start**

This chapter is meant for experienced users. It briefly summarizes the necessary steps to prepare and run an assay. Please note that in terms of the 2100 Expert Software, a method resembles an extended assay, which also includes additional administrative data such as operator, instrument, reporting, and workflow settings. These additional functions are unlocked with the 2100 Expert Security Pack.

### **3 Looking at 2100 Expert Software**

Before you start running methods/assays on the Agilent 2100 Bioanalyzer system, you should familiarize yourself with the 2100 Expert Software. This chapter shows how to get started with the 2100 Expert Software, and outlines its main operational possibilities.

### **4 Running and Evaluating Electrophoretic Methods/Assays**

This chapter explains how electrophoretic measurements are made using the 2100 Bioanalyzer system, gives detailed descriptions of all steps necessary to run electrophoretic assays, and shows how to analyze and evaluate results using electropherograms and gel-like images.

## **5 Working with Chip Data and Methods/Assays**

This chapter shows you what to do to open, save, import and export files, and how to print the results.

## **6 Administering System Functions and the Security Pack**

This chapter is your guideline for configuring the 2100 Expert Software.

## **7 Running Instrument Diagnostics**

This chapter shows how to use the diagnostic tests to check the 2100 Bioanalyzer instrument for proper functioning.

## **8 Performing Verifications**

This chapter describes how you can validate your 2100 Bioanalyzer system.

## **9 Products, Spare Parts, and Accessories**

This chapter lists all parts and accessories—including reorder numbers.

# Contents

<b>1</b>	<b>Typographic conventions in this Manual</b>	<b>7</b>
<b>2</b>	<b>Quick Start</b>	<b>9</b>
	Preparing the Agilent 2100 Bioanalyzer Instrument	10
	Switching on the Agilent 2100 Bioanalyzer	11
	Running a Measurement	12
	During the chip run	20
	Viewing the Measurement Results	21
	What You Can do When the Measurement is Finished	23
<b>3</b>	<b>Looking at 2100 Expert Software</b>	<b>25</b>
	Introduction to the Key Features of the 2100 Expert Software	26
	Starting the 2100 Expert Software	27
	2100 Expert Software Work Area	29
	Closing 2100 Expert Software	37
	The 2100 Expert Security Pack	38
<b>4</b>	<b>Running and Evaluating Electrophoretic Methods/Assays</b>	<b>51</b>
	Principles of Nucleic Acid and Protein Analysis on a Chip	53
	Preparing and Running an Electrophoretic Method or Assay	57
	Analyzing and Evaluating the Results of an Electrophoretic Method or Assay	85
	Result Flagging	145
<b>5</b>	<b>Working with Chip Data and Methods/Assays</b>	<b>157</b>
	Working with Chip Data and Methods/Assays	158
	2100 Expert Data Overview	159
	Handling Methods	162
	Handling Chip Data	166
	Organizing, Backing up, and Archiving 2100 Expert Data	167
	Importing Data	169
	Exporting Data	173
	Printing Reports	180
	Configuring Tables	187

<b>6</b>	<b>Administering System Functions and the Security Pack</b>	<b>191</b>
	Administering System Functions and the Security Pack	192
	Access Control	193
	Pre-configurations for the 2100 Expert Software	198
	Configuring the 2100 Expert Software	207
	Exporting and Importing Multiple Data Files	215
	Archiving Data	217
	Using Log Books	220
<b>7</b>	<b>Running Instrument Diagnostics</b>	<b>227</b>
	Running Instrument Diagnostics	228
	How to Run Instrument Diagnostics Test	230
<b>8</b>	<b>Performing Verifications</b>	<b>233</b>
	Performing Verifications	234
	Verifications	235
<b>9</b>	<b>Products, Spare Parts, and Accessories</b>	<b>243</b>
	Products, Spare Parts, and Accessories	244

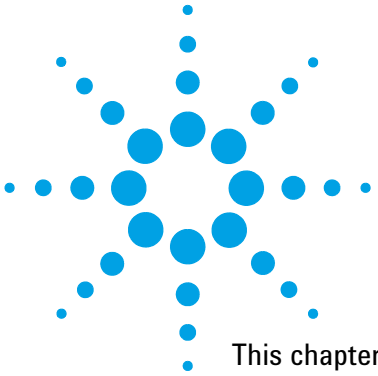

# 1 Typographic conventions in this Manual

This chapter shows you how to make efficient use of this manual.



## 1 Typographic conventions in this Manual

### In This Guide...

This manual uses convenient online navigation features and follows certain typographic conventions.

**Table 1** Typographic conventions

Highlight	
<i>Italic</i>	<ul style="list-style-type: none"><li>• Emphasis Example: <i>Right-click</i> the ...</li><li>• Term Example: <i>Dot plots</i> show events as dots.</li><li>• Reference to another document Example: Refer to the <i>Agilent 2100 Bioanalyzer System Troubleshooting and Maintenance Guide</i>.</li></ul>
Blue	<ul style="list-style-type: none"><li>• Cross-reference or hyperlink Examples: "Introduction to the Key Features of the 2100 Expert Software" on page 26 <a href="https://www.agilent.com/en/product/automated-electrophoresis/bioanalyzer-systems">https://www.agilent.com/en/product/automated-electrophoresis/bioanalyzer-systems</a></li></ul>
Courier	Code Example: . the command line parameter -port 2 ...
<b>Courier bold</b>	<ul style="list-style-type: none"><li>• User input Example: Enter 50 <b>MB</b>.</li></ul>
<b>Bold</b>	On-screen element Example: ... the <b>OK</b> button.

If you have any questions this manual cannot answer, please contact Agilent for additional support at:  
<https://www.agilent.com/en/product/automated-electrophoresis/bioanalyzer-systems>.



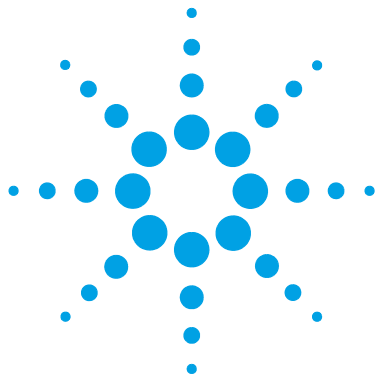

## 2 Quick Start

Preparing the Agilent 2100 Bioanalyzer Instrument	10
Switching on the Agilent 2100 Bioanalyzer	11
Running a Measurement	12
During the chip run	20
Viewing the Measurement Results	21
What You Can do When the Measurement is Finished	23

This chapter is meant for experienced users. It briefly summarizes the necessary steps to prepare and run an assay. Please note that in terms of the 2100 Expert Software, a method resembles an extended assay, which also includes additional administrative data such as operator, instrument, reporting, and workflow settings. These additional functions are unlocked with the 2100 Expert Security Pack.



## 2 Quick Start

### Preparing the Agilent 2100 Bioanalyzer Instrument

# Preparing the Agilent 2100 Bioanalyzer Instrument

- 1 Make sure a clean electrode cartridge is installed.
- 2 If you want to change the cartridge, follow the instructions in [“Loading the Electrophoresis Chip into the 2100 Bioanalyzer Instrument”](#) on page 63 .

## Switching on the Agilent 2100 Bioanalyzer

- 1 Make sure the 2100 Bioanalyzer instrument is connected to line power and connected to the PC.
- 2 Turn on the line switch at the rear of the instrument.

The status LED at the front of the 2100 Bioanalyzer instrument should light up.

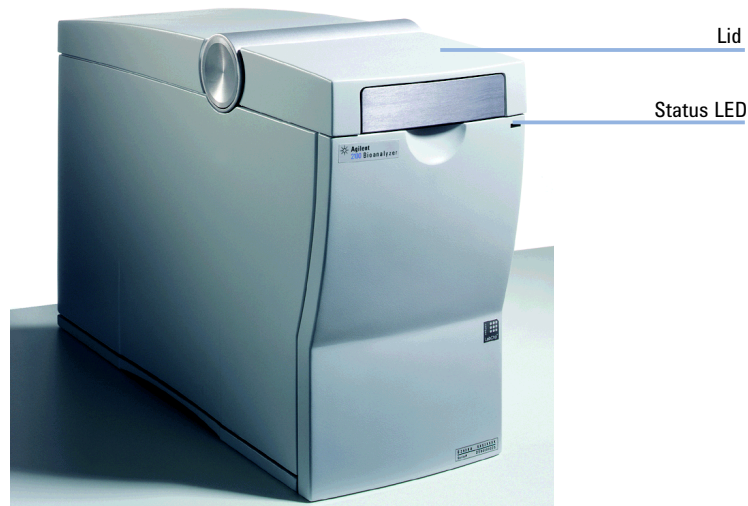

The status LED shows you the current status of the instrument.

Signal	Meaning
Green light	Instrument is switched on and ready for measurement.
Green blinking	Measurement is running.
Orange blinking	Instrument is busy (running self-diagnostic, for example).
Red light	Instrument is not ready for measurement. Switch the instrument off and on again. If the problem persists, contact Agilent service.

## Running a Measurement

- 1 To start the 2100 Expert Software on the connected PC, go to your desktop and double-click the following icon:



- 2 The **2100 Environment Checker** (see “[The 2100 Environment Checker](#)” on page 28) will validate computer settings in the background. You might have to acknowledge these warnings before the software will start.
- 3 The access to the 2100 Expert Software and its functionality is controlled by the installed *Security Pack*. You need to authenticate yourself with your user name and password.

The image shows a '2100 expert - Logon' dialog box. The title bar is blue with the text '2100 expert - Logon'. The main area has a light gray background. On the left, there is an icon of a silver keychain with a white card and a yellow key. To the right of the icon, the text reads: 'Enter user name, password and select role that is valid for the 2100 expert user.' Below this text are four input fields: 'User name : advaoper', 'Full name : Mr. Advanced', 'Password : \*\*\*\*\*', and 'Roles : Advanced Operator' (with a dropdown arrow). At the bottom, there are three buttons: 'OK', 'Cancel', and 'Option >>'.

2100 expert - Logon	
Enter user name, password and select role that is valid for the 2100 expert user.	
User name :	advaoper
Full name :	Mr. Advanced
Password :	*****
Roles :	Advanced Operator
OK Cancel Option >>	

For more information on the user management of 2100 Expert Software, see section *Looking at 2100 Expert Software*.

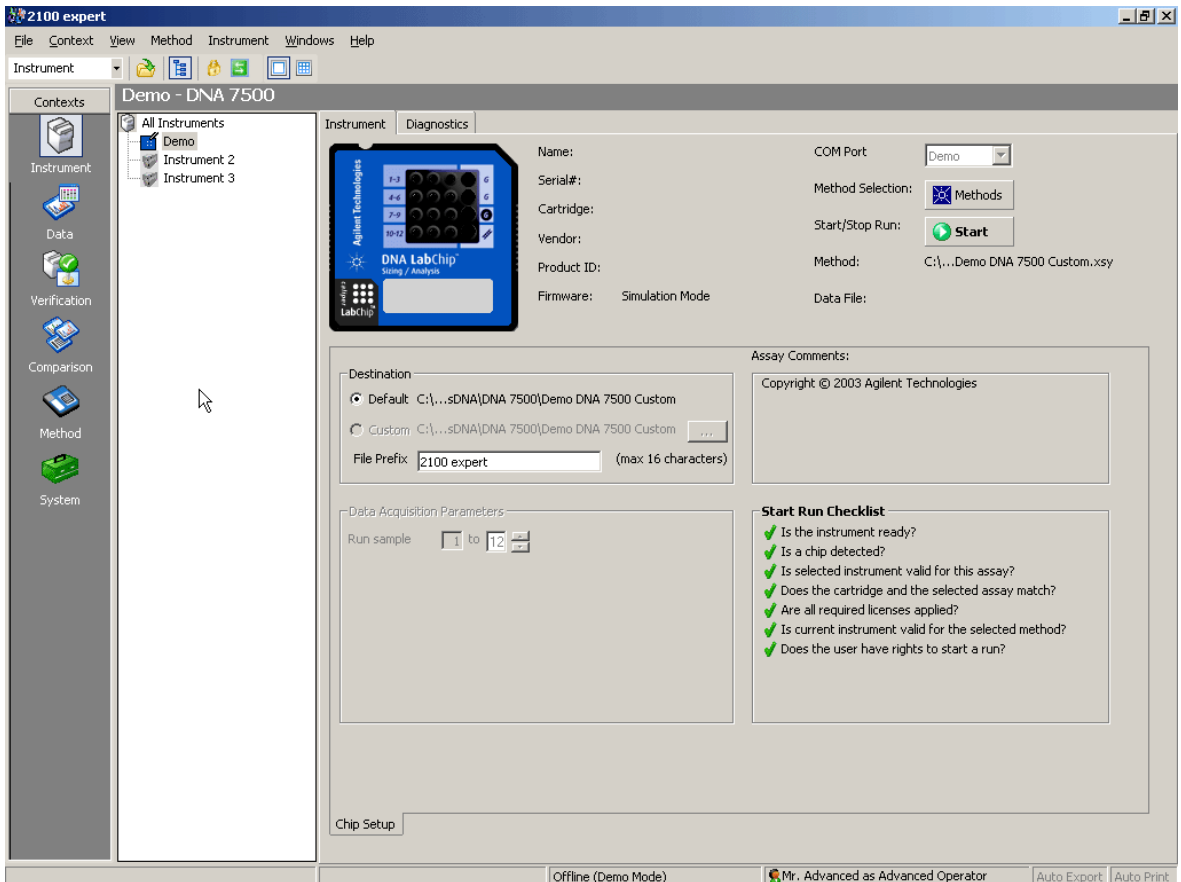

After startup of the software, you enter the **Instrument** context:



## 2 Quick Start

### Running a Measurement

The **Instrument** tab shows you the status of the 2100 Bioanalyzer instrument:

Icons	Meaning
	Instrument detected, lid is open.
	Instrument detected. Lid is closed, but no chip is inserted.
	No instrument has been detected. Check the <b>COM Port</b> setting (see figure under step 3), the RS 232 connection cable, the power cable or the USB connection, and the power switch. For details on how to set up the 2100 Bioanalyzer system and connect it to a PC, see <i>Agilent 2100 Bioanalyzer System Installation and Safety Guide</i> .

#### NOTE

If you started 2100 Expert Software for the first time after installation, you first need to activate the different software modules with your license keys. See [“How to Activate Software Licenses”](#) on page 213 for details.

- 4 Make sure that an instrument has been detected before continuing.
- 5 Select an assay/method for the chip run. On the **Instrument** tab, click the **Assays/Methods** button.

OR

Click the **Assays/Methods** menu.

Both will open a menu, allowing you to select an assay/method for the measurement.

**NOTE**

You can also select **File > Open File to Run**. This opens a dialog box allowing you to load either an assay/method (.xsy) or a chip data file (.xad).

---

- 6 Prepare the samples and the chip. Edit destination and data acquisition parameters such as number of samples, and insert sample information in the chip summary table. For detailed information on sample and chip preparation refer to:
  - *Kit Guides* that are available for each kit (see *Agilent 2100 Bioanalyzer Help Desk*)

**NOTE**

When preparing chip and samples, pay attention to the essential measurement practices described in "[Essential Measurement Practices \(Electrophoretic Methods/Assays\)](#)" on page 61 or as described in the respective Kit Guide.

---

## 2 Quick Start

### Running a Measurement

#### 7 Insert the chip in the 2100 Bioanalyzer instrument:

##### a Open the lid.

The status of the instrument is updated on the **Instrument** tab.

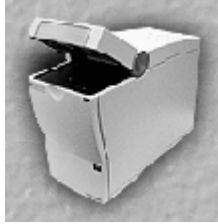

##### b Check that the cartridge is inserted properly. For details, please refer to [“Loading the Electrophoresis Chip into the 2100 Bioanalyzer Instrument”](#) on page 63 .

##### c Place the chip into the receptacle.

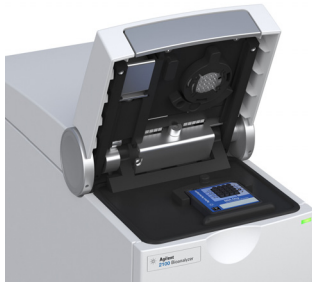

**Figure 1** Electrode cartridge inserted in the instrument (graphic shows an example).

The chip fits only one way. Do not force it into place.

### CAUTION

Do not force the lid closed.

This can damage the cartridge.

- If the lid does not close without force, check that chip is inserted correctly. When the software recognizes an inserted chip, the chip is shown on the Instrument tab. If you have closed the lid, and the software has not recognized the chip, verify that the cartridge is properly installed into the instrument. Close the lid.



- d Carefully close the lid.

The electrodes in the cartridge fit into the wells of the chip.

When the chip is detected, the image on the **Instrument** tab changes to a chip.

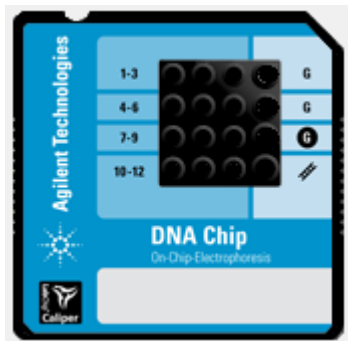

If the chip is not detected, open and close the lid again.

**NOTE**

The chip that is displayed depends on the assay that was selected in the software, not on the actual chip that was inserted in the bioanalyzer.

- 8 On the **Instrument** tab, click .

## 2 Quick Start

### Running a Measurement

- 9 Before the chip run starts, you are prompted to confirm this action with your electronic signature. This action is then recorded and will be available for reviewing in the signature log and the audit trail.

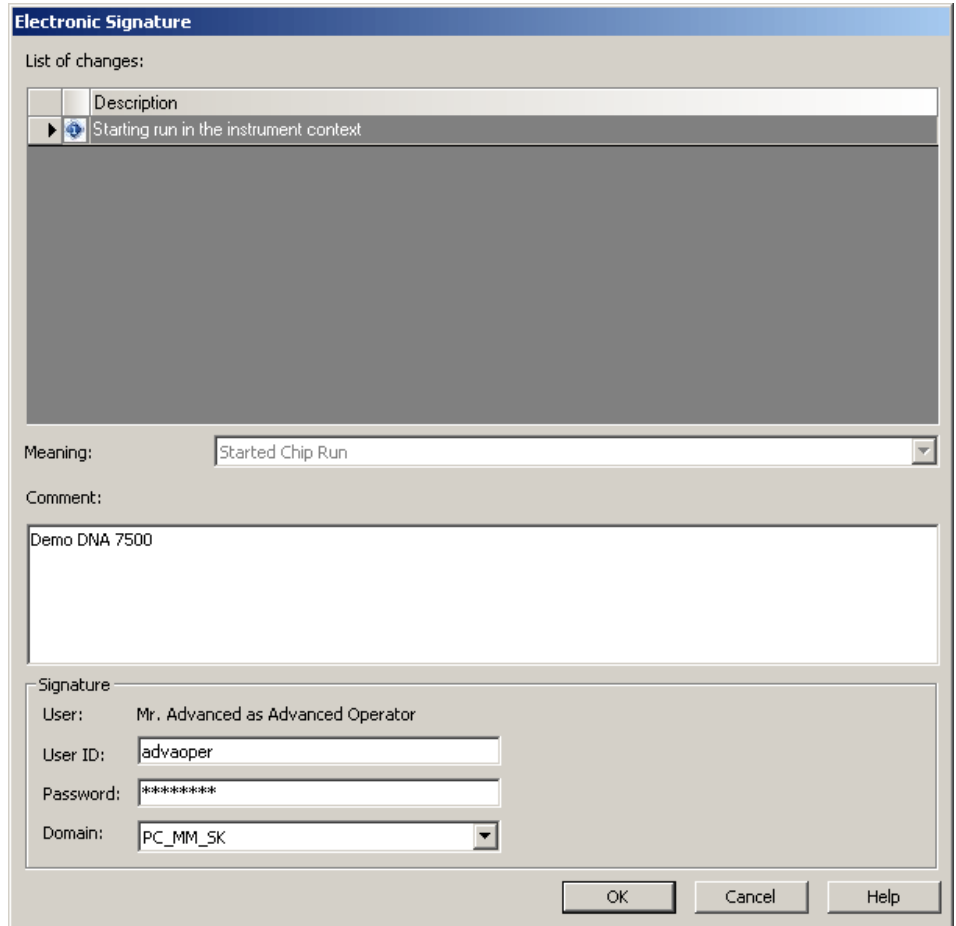

The dialog box is titled "Electronic Signature" and contains the following fields and controls:

- List of changes:** A table with a "Description" header and one entry: "Starting run in the instrument context".
- Meaning:** A dropdown menu with "Started Chip Run" selected.
- Comment:** A text area containing "Demo DNA 7500".
- Signature:** A section with the following fields:
  - User:** "Mr. Advanced as Advanced Operator"
  - User ID:** "advaoper"
  - Password:** "\*\*\*\*\*"
  - Domain:** "PC\_MM\_SK" (dropdown menu)
- Buttons:** "OK", "Cancel", and "Help" buttons at the bottom right.

The chip run starts. The **Raw Signals** sub-tab shows an electropherogram of the currently measured sample. The name of the sample is displayed above the graph. The graph is a “live” plot of the migration time against fluorescence units (raw data, including background fluorescence, for example).

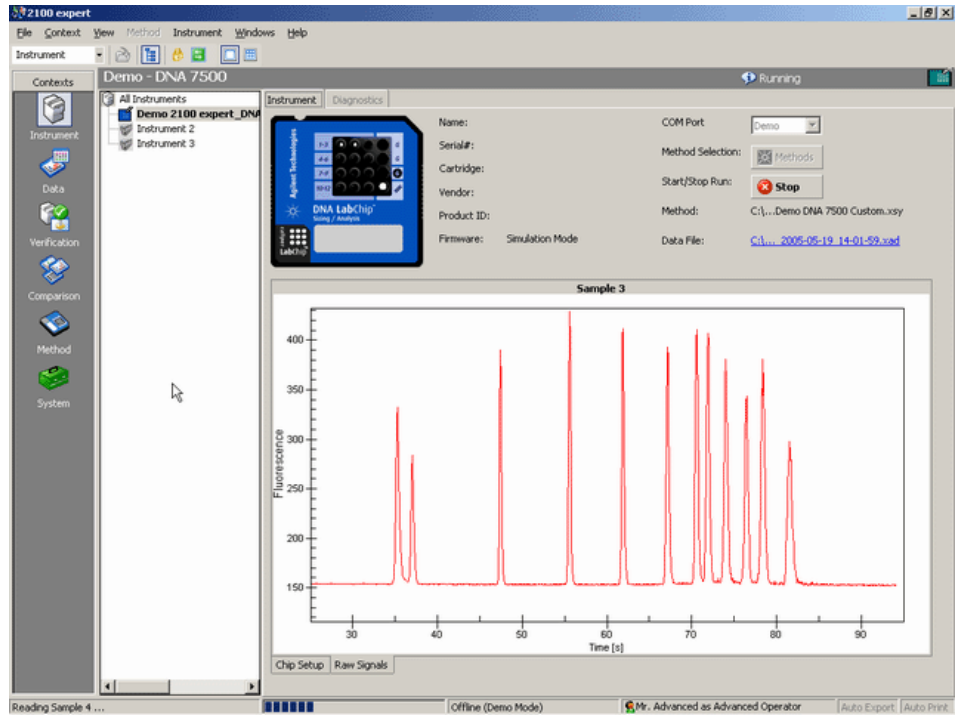

The number of the sample that is currently being measured is indicated on the information bar:



The status bar at the bottom of the window shows the measurement progress for the chip run and the COM port number used for data acquisition.

**NOTE**

The signature must be saved with the correct setting in the **Meaning** field. If this setting cannot be pre-selected by 2100 Expert Software, you must do this selection manually.

**NOTE**

The 2100 Expert Software Security Pack restricts access to data and functionality to users who are logged in with certain roles. See User Role Model for details (“[Access Control](#)” on page 39).

## During the chip run

- 1 View the chip data file in the **Data** context by clicking on the name of the **Data File**.

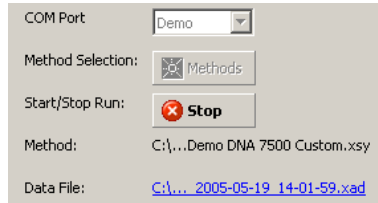

During the chip run, you can do the following:

- Switch to any other context. For example, you can evaluate any chip data file in the **Data** context, or compare samples in the **Comparison** context.
- If necessary, abort the chip run by clicking on the **Stop** button. You need to confirm this action with your electronic signature.

All data that was collected up to the stop point will be saved.

- 2 Switch to any other context. For example, you can evaluate any chip data file in the **Data** context, or compare samples in the **Comparison** context.
- 3 If necessary, abort the chip run by clicking on the **Stop** button. You need to confirm this action with your electronic signature.

All data that was collected up to the stop point will be saved.

## Viewing the Measurement Results

To view the results, switch to the **Data** context. The data file that has just been generated by your chip run is displayed. The **Chip Summary** tab shows information on your chip data file, and lets you modify or enter comments regarding chip, samples, and study.

The screenshot shows the 2100 Expert software interface. The main window title is "2100 expert - C:\...ea\Data\dsDNA\DNA 7500\Demo DNA 7500 Custom\2100 expert\_DNA 7500\_00000\_2005-05-19\_14-01-59.xad". The interface is divided into several sections:

- Contexts:** A vertical sidebar on the left with icons for Instrument, Data, Verification, Comparison, Method, and System. The "Data" context is selected.
- File Tree:** A tree view under "All Files" showing a folder "2100 expert\_DNA 7500\_00" containing "All Samples" (Sample 1 to Sample 12) and a "Ladder".
- Analysis Tab:** The "Chip Summary" tab is active, showing a thumbnail of a DNA LabChip and the following information:
  - Data File : 2100 expert\_DNA 7500\_00000\_2005-05-19\_14-01-59.xad
  - Location : C:\...2100 expert\SecuredArea\Data\dsDNA\DNA 7500\Demo DNA 7500 Custom
  - Created : Mai 19, 2005 14:02:05
  - Modified : Mai 19, 2005 14:04:07
  - Software : Created by version B.02.01.SI211, modified by B.02.01.SI211
  - File Version : 1 (Latest version)
- Table:** A table with columns: Sample Name, Sample Comment, Rest. Digest, Status, Observation, Result Label, Result Color, and Approved.
 

Sample Name	Sample Comment	Rest. Digest	Status	Observation	Result Label	Result Color	Approved
1 PCR Mix 1	ref.	<input type="checkbox"/>	✓				⚠ Not Reviewed
2 PCR Mix 3a		<input type="checkbox"/>	✓				⚠ Not Reviewed
3 Sample 3		<input type="checkbox"/>	✓				⚠ Not Reviewed
4 Sample 4		<input type="checkbox"/>	✓				⚠ Not Reviewed
5 Sample 5		<input type="checkbox"/>	✓				⚠ Not Reviewed
6 Sample 6		<input type="checkbox"/>	✓				⚠ Not Reviewed
7 Sample 7		<input type="checkbox"/>	✓				⚠ Not Reviewed
8 Sample 8		<input type="checkbox"/>	✓				⚠ Not Reviewed
9 Sample 9		<input type="checkbox"/>	✓				⚠ Not Reviewed
10 Sample 10		<input type="checkbox"/>	✓				⚠ Not Reviewed
11 Sample 11		<input type="checkbox"/>	✓				⚠ Not Reviewed
12 Sample 12		<input type="checkbox"/>	✓				⚠ Not Reviewed
- Chip Lot #:** A text input field.
- Reagent Kit Lot #:** A text input field.
- Chip Comments:** A text area containing "prepared by laura".
- Buttons:** "Import..." and "Export..." buttons.
- Footer:** "Mr. Advanced as Advanced Operator" and "Auto Export: Auto Print".

## 2 Quick Start

### Viewing the Measurement Results

- 1 In the tree view panel, click any sample name or the ladder.  
This selects the **Electropherogram** tab, which displays a data plot of size/migration time versus fluorescence intensity.

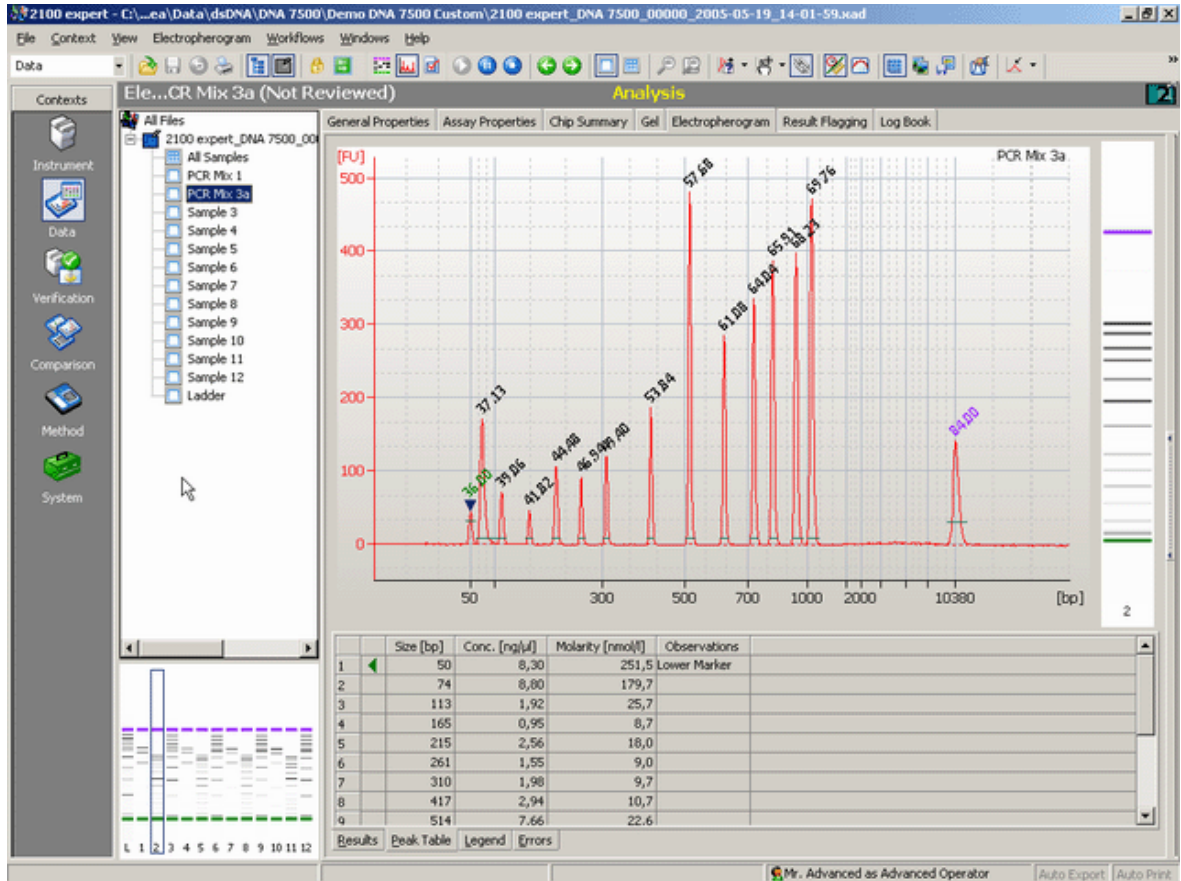

Peaks have automatically been detected, and their characteristics such as size, concentration, purity, or molarity have been calculated and are shown in the **Peak Table** at the bottom of the window.

## What You Can do When the Measurement is Finished

When the measurement is finished, you can:

- Document your chip run by entering or modifying sample names, chip comments, and study information, for example.
- Evaluate the measurement results by analyzing gel-like images, electropherograms and result flagging.
  - [“Analyzing and Evaluating the Results of an Electrophoretic Method or Assay”](#) on page 85
- Print the results to document them on paper or an electronic format, such as HTML or PDF.  
See [“Printing Reports”](#) on page 180.
- Export the results or parts of them for further evaluation in other applications.  
See [“Exporting Data”](#) on page 173.
- Compare the results with the results of other chip runs in the **Comparison** context. See [“Comparing Samples from Different Electrophoretic Chip Runs”](#) on page 139.
- Pass the results through the predefined workflow.  
See [“Workflow Control”](#) on page 50
- Insert the next chip in the 2100 Bioanalyzer instrument and start a new chip run.

## **2 Quick Start**

### **What You Can do When the Measurement is Finished**



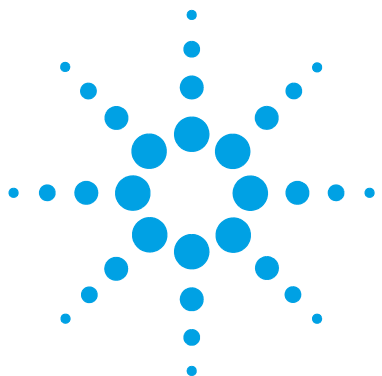

## 3 Looking at 2100 Expert Software

Introduction to the Key Features of the 2100 Expert Software	26
Starting the 2100 Expert Software	27
The 2100 Environment Checker	28
2100 Expert Software Work Area	29
Operating Modes	30
Closing 2100 Expert Software	37
The 2100 Expert Security Pack	38
Access Control	39
Data Integrity	42
Handling of Electronic Signatures	43
Workflow Control	50

Before you start running methods/assays on the Agilent 2100 Bioanalyzer system, you should familiarize yourself with the 2100 Expert Software. This chapter shows how to get started with the 2100 Expert Software, and outlines its main operational possibilities.



## Introduction to the Key Features of the 2100 Expert Software

The Agilent 2100 Expert Software is characterized by the following key features:

- 2100 Expert Software provides a single software platform with a common user interface for running, analyzing, evaluating, presenting, and comparing DNA, RNA, and protein parameters.
- 2100 Expert Software provides an optional Security Pack that needs to be ordered separately as G2949CA and is then activated with a license key. This Security Pack activates user management functions and electronic signature to meet the Food and Drug Administration (FDA) requirements (21 CFR Part 11).
- 2100 Expert Software provides detailed installation verification and system verification tests on the 2100 Bioanalyzer system.
- 2100 Expert Software allows having multiple chip data and/or method/assay files open at the same time.
- 2100 Expert Software features an data evaluation tool (**Comparison** context) allowing comparison of measurement results (of same method/assay class) from different chips.
- 2100 Expert Software offers the RNA Integrity Number (RIN), a reliable tool to automatically compare integrity of RNA samples.
- 2100 Expert Software features improved integration including manual integration (available for DNA and Protein methods/assays only).
- 2100 Expert Software allows color-coded result flagging with pre-defined or custom result flagging rules. Flagging rules can be applied to measurement results.
- 2100 Expert Software has customizable result tables and gel-like images.
- 2100 Expert Software allows to control two 2100 Bioanalyzer instruments from one PC. It is possible to run measurements on two 2100 Bioanalyzer instruments *at the same time*.
- 2100 Expert Software has improved printing and reporting functions.
- 2100 Expert Software has extended instrument diagnostics functionality.

## Starting the 2100 Expert Software

- 1 Go to your desktop and double-click the following icon:



OR

From the Windows **Start** menu, select **All Programs > Agilent 2100 Bioanalyzer > 2100 Expert**.

- 2 The **2100 Environment Checker** (see [“The 2100 Environment Checker”](#) on page 28) will validate computer settings in the background. You might have to acknowledge these warnings before the software will start.
- 3 The access to the 2100 expert and its functionality is controlled by the installed **Security Pack**. You need to authenticate yourself with your user name and password.

The image shows a dialog box titled '2100 expert - Logon'. The title bar is blue with white text. The main area has a light gray background. On the left side, there is an icon of a silver key with a blue snowflake on its head and a yellow key. To the right of the icon, the text reads: 'Enter user name, password and select role that is valid for the 2100 expert user.' Below this text are four input fields: 'User name :' with the text 'advaoper', 'Full name :' with the text 'Mr. Advanced', 'Password :' with the text '\*\*\*\*\*', and 'Roles :' with a dropdown menu showing 'Advanced Operator'. At the bottom of the dialog box, there are three buttons: 'OK', 'Cancel', and 'Option >>'. The 'OK' button is highlighted with a blue border.

For more information on the user management of 2100 Expert Software, see [“The 2100 Expert Security Pack”](#) on page 38.

The 2100 Expert Software application window appears. [“2100 Expert Software Work Area”](#) on page 29 gives an overview of the application window.

## The 2100 Environment Checker

At startup of the 2100 Expert Software a few parameters, such as regional settings, setup of a printer and printer margins are checked automatically.

Eventually, a pop-up window will appear that indicates warnings and errors:

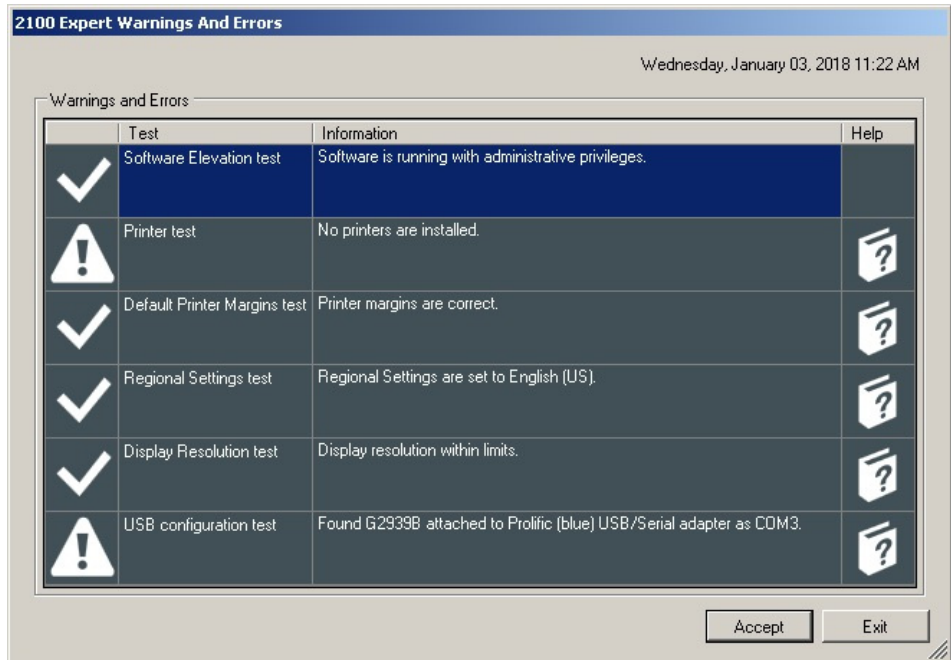

### NOTE

For **Security Pack** users: All changes to above settings have to be performed for the generic 2100 System user account. Please login with this Windows user account and make the according changes.

- Setup a default printer (“[Setup a default printer](#)” on page 198)
- Default printer margins (“[Default Printer margins](#)” on page 199)
- Configure regional settings (“[Configure regional settings](#)” on page 202)
- Display settings (“[Display settings](#)” on page 205)
- USB Configuration (“[USB-to-Serial adapter configuration](#)” on page 206)

## 2100 Expert Software Work Area

The 2100 Expert Software has standard elements such as pull-down menus and toolbars, and the main working area, which contains several tabs, some of which have sub-tabs. The 2100 Expert Software area has the following regions (demonstrated at the **Data** context):

The screenshot shows the 2100 Expert Software interface with the following regions identified by callouts:

- Title Bar:** The top bar of the application window.
- Menu Bar:** The bar containing the File, Context, View, Gel, Workflows, Windows, and Help menus.
- Toolbar:** The bar containing various icons for file operations and analysis.
- Info Bar:** The bar displaying the current context, 'Gel...CR Mix 3a (Not Reviewed)'. Below it is a 'Contexts' sidebar with icons for Instrument, Data, Verification, Comparison, Method, and System.
- Context Bar:** The bar displaying the current analysis, 'Analysis'.
- Tree View:** The sidebar showing a hierarchical view of files, including 'All Files', '2100 expert\_DNA 7500\_000', 'All Samples', and 'PCR Mix: 3a'.
- Tabs:** The tabs at the top of the main working area, including 'General Properties', 'Assay Properties', 'Chip Summary', 'Gel', 'Electropherogram', 'Result Flagging', and 'Log Book'.
- Sub-tabs:** The sub-tabs within the 'Gel' tab, including 'General Properties', 'Assay Properties', 'Chip Summary', 'Gel', 'Electropherogram', 'Result Flagging', and 'Log Book'.
- Lower Panel:** The panel at the bottom of the main working area, displaying a 'DNA LabChip' image and a table of results.
- Status Bar:** The bar at the bottom of the application window, displaying 'Mr. Advanced as Advanced Operator' and 'Auto Export'.

The main working area displays a gel electrophoresis image with a table of results. The table has the following columns: Size [bp], Conc. [ng/μl], Molarity [nmol/l], and Observations. The data is as follows:

Size [bp]	Conc. [ng/μl]	Molarity [nmol/l]	Observations
50	8,30	251,5	Lower Marker
74	8,80	179,7	
113	1,92	25,7	
165	0,95	8,7	
215	2,55	18,0	
261	1,55	9,0	
310	1,98	9,7	
417	2,94	10,7	
514	7,64	22,4	

The 'Setpoint Explorer' pop-up menu is visible, showing options: Export..., Configure Columns..., Copy To Clipboard (Ctrl+C), Manually Set Lower Marker, Manually Set Upper Marker, and Exclude Peak.

## Operating Modes

The 2100 Expert Software can be operated in six modes, called "contexts":

- Instrument Context
- Data Context
- Verification Context
- Comparison Context
- Method or Assay Context
- System Context

### NOTE

The contexts work independent from each other regarding their data. This means, for example, that you can review data and run measurements at the same time. Please note that in terms of the 2100 Expert Software, a method resembles an extended assay, which also includes additional administrative data such as operator, instrument, reporting, and workflow settings.

Using the **Contexts** bar, the **Context** menu, or the selection list in the **toolbar**, you can switch between the contexts:

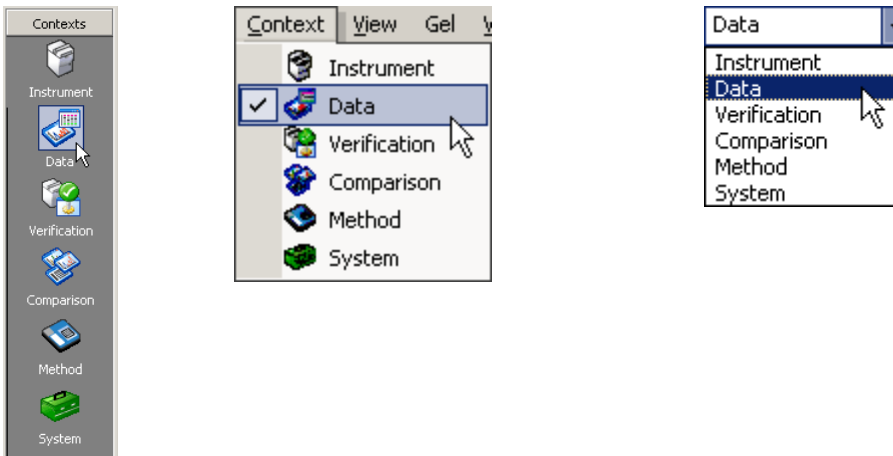

### NOTE

Menus, toolbars, the tree view, and the main working area (tabs) significantly change when you switch between the contexts.

An introduction to the six contexts is given in the following.

## Instrument Context

On startup, 2100 Expert Software enters the **Instrument** context, where you can run DNA, RNA or protein methods/assays by selecting a method/assay file and starting the chip run—provided that the 2100 Bioanalyzer instrument is properly connected, a chip is inserted, and the lid is closed.

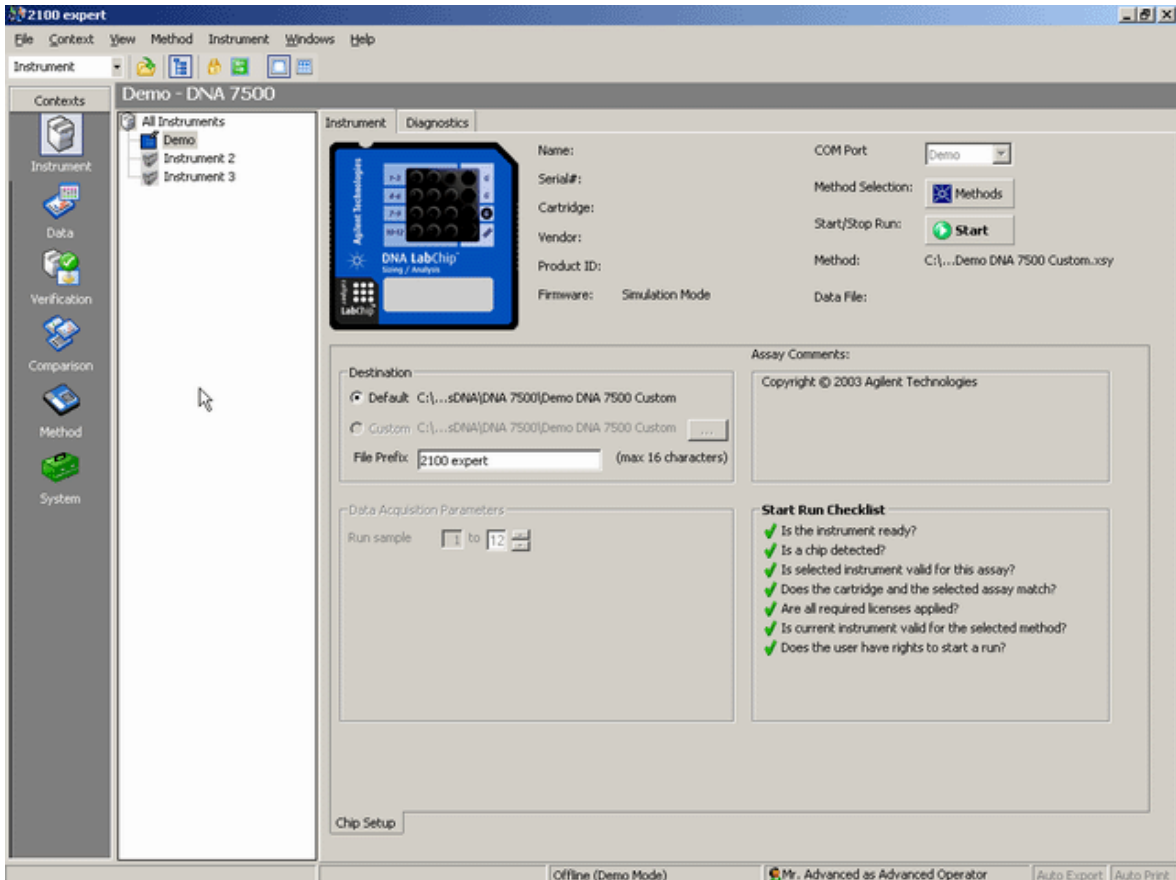

### NOTE

If two 2100 Bioanalyzer instruments are connected to your PC, you can run both in parallel.

During the chip run(s), you can view the status of the instrument(s): information and real time acquisition data.

### 3 Looking at 2100 Expert Software 2100 Expert Software Work Area

In the **Instrument** context, it is also possible to run hardware diagnostic tests on all connected instruments. Refer to “[Running Instrument Diagnostics](#)” on page 227 for details.

#### Data Context

In the **Data** context, you can

- view, analyze, and evaluate the results of your chip runs that are presented as electropherograms, gel-like images, histograms, dot plots, and result tables.
- export and print the results of your chip runs.

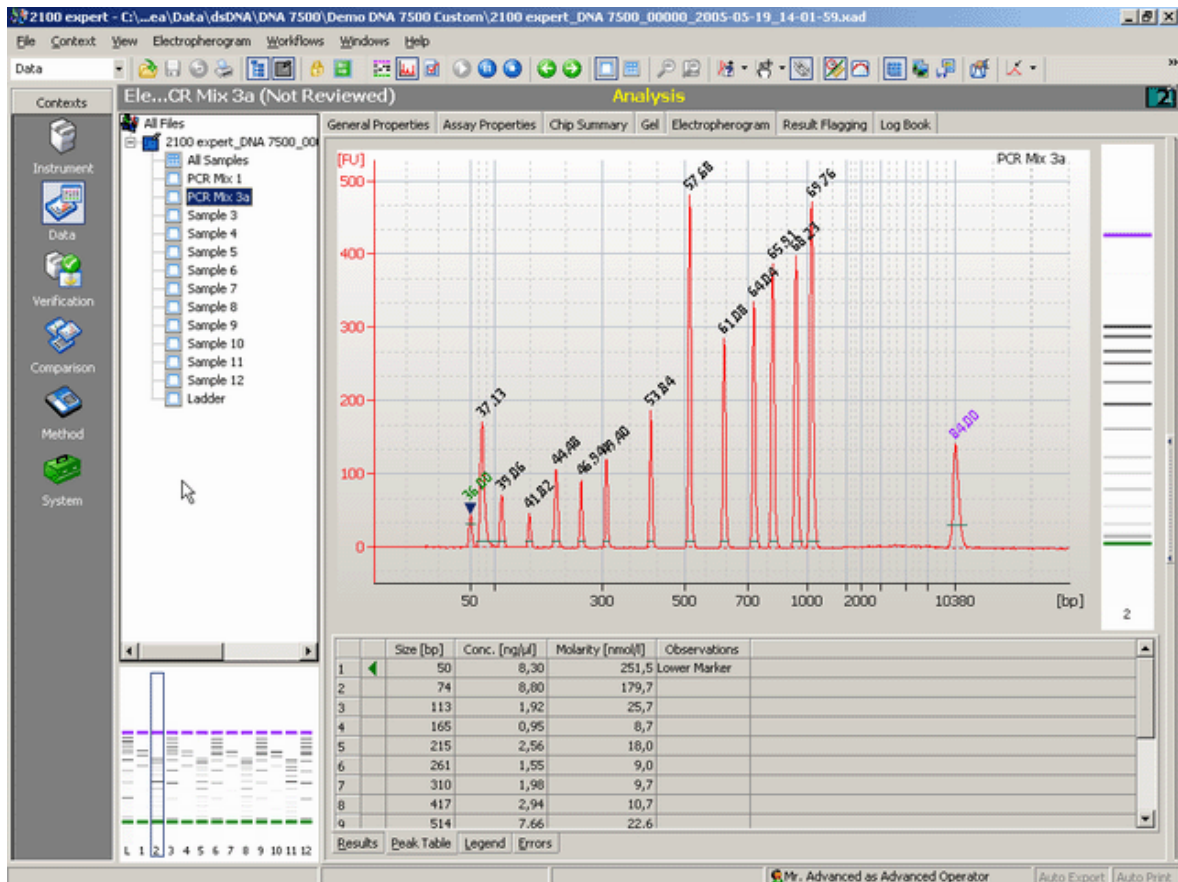

The measurement data is stored in .xad files.



## Verification Context

The **Verification** context is used to run and document qualification tests.

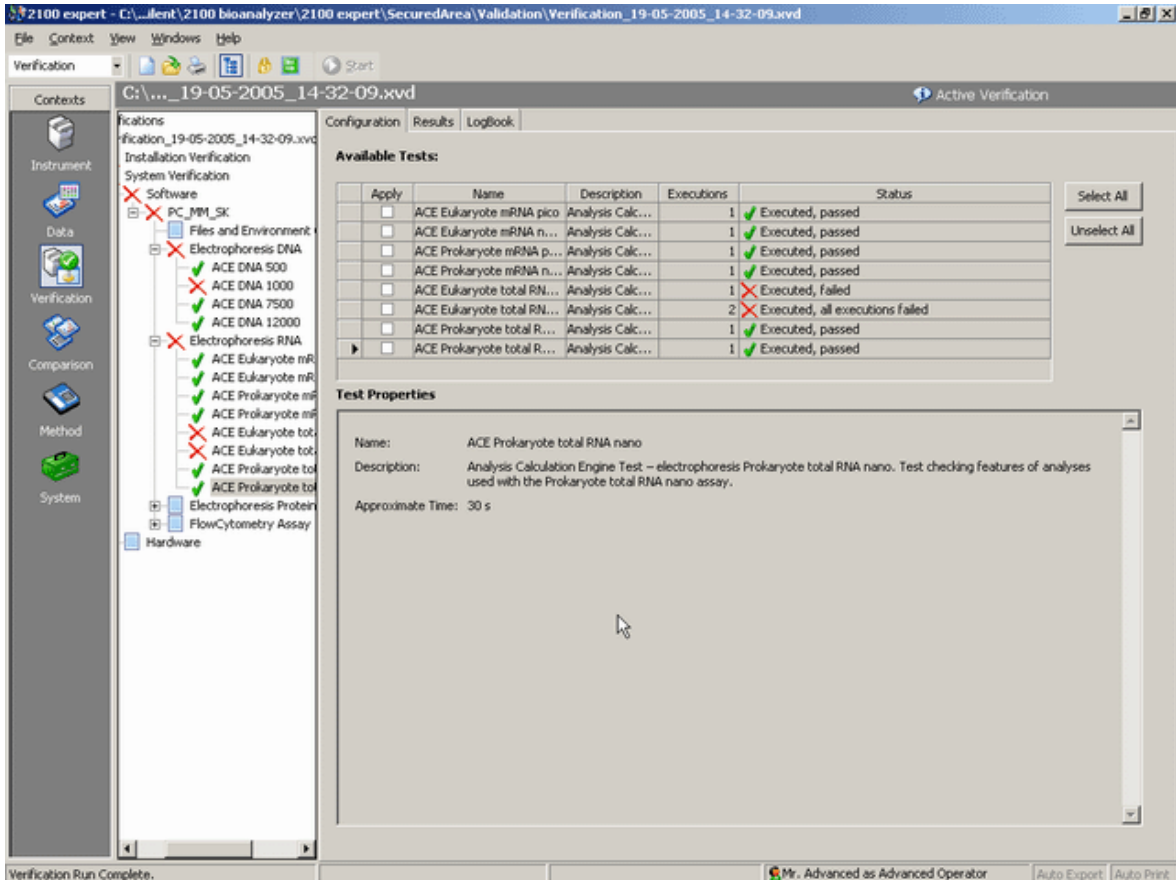

For the 2100 Bioanalyzer instrument and the Expert Software, tests can be run for:

- Installation Verification
- System Verification

Verification results are automatically saved in .xvd files. You can re-open .xvd files to review verification results.

For details, refer to “Performing Verifications” on page 233.

### 3 Looking at 2100 Expert Software 2100 Expert Software Work Area

## Comparison Context

In the **Comparison** context, you can open multiple electrophoretic chip data files and compare samples of the same assay class (DNA 1000, for example). It is possible to overlay electropherograms and compare the results.

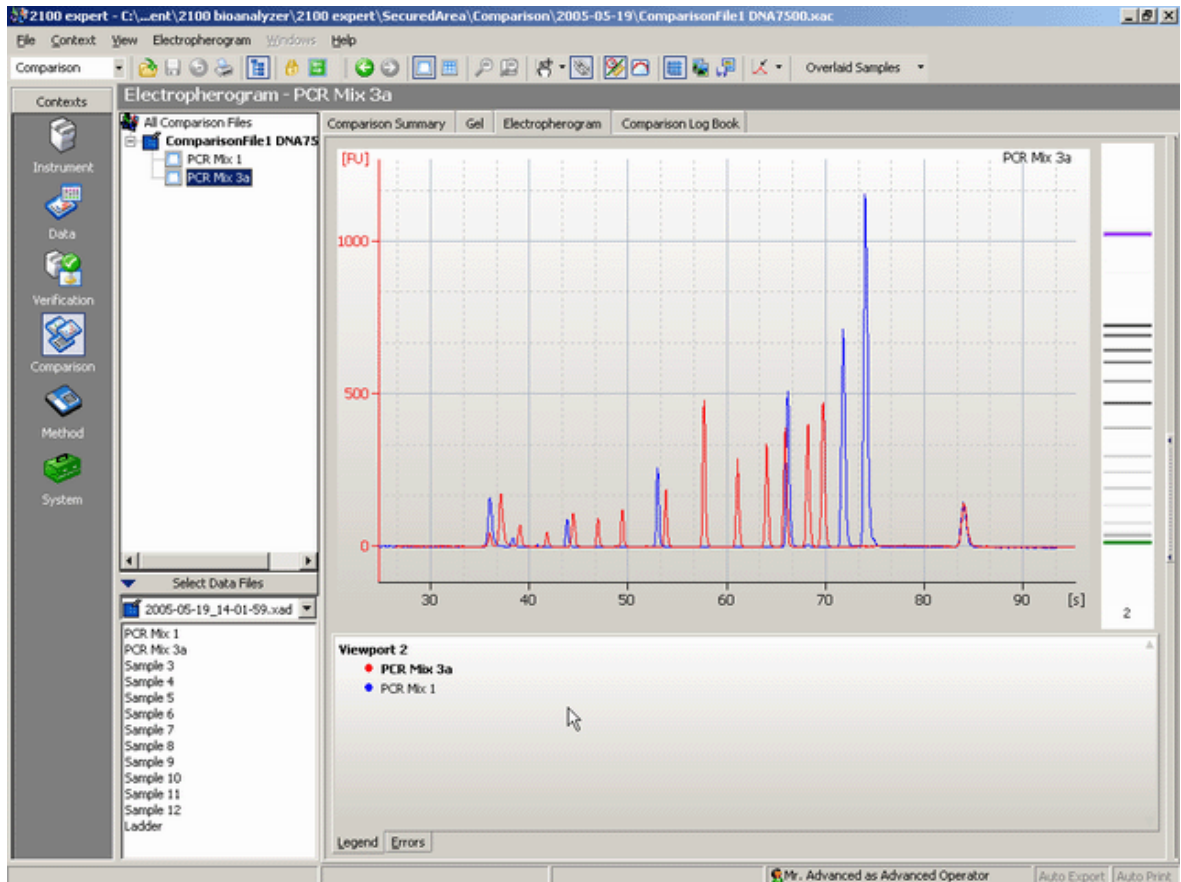

Comparison results can be saved in .xac files. You can re-open .xac files to review the comparison results and to add further samples for comparison.

## Method/Assay Context

In the **Method/Assay** context, you can create your own methods/assays based on Agilent templates by modifying certain data (e. g. data analysis setpoints, sample names or result flagging). Within a method/assay, you also define general settings, which include the instrument(s) to be used, the relevant study, the workflow to be followed, and the reporting elements.

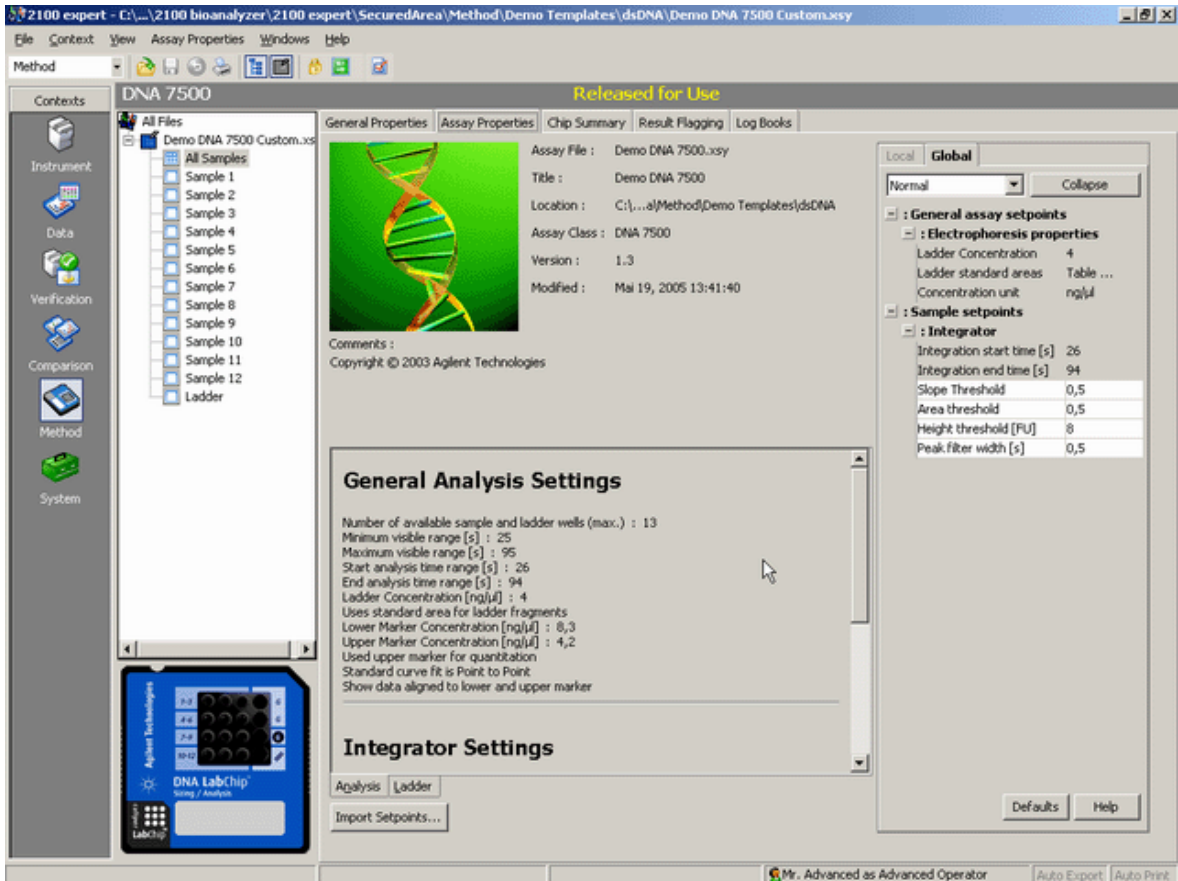

Methods/Assays are stored as .xsy files.

## System Context

In the **System** context, you can

- define **System Wide Settings** for the 2100 Expert Software such as settings for default file names and directories, signal colors, auto export functions, or default export directories
- view the contents of the **System Log Book**
- add or delete users and assign the required roles to the users (available to administrators only)
- make use of the import/export and archiving functions (available to administrators and backup operators only)

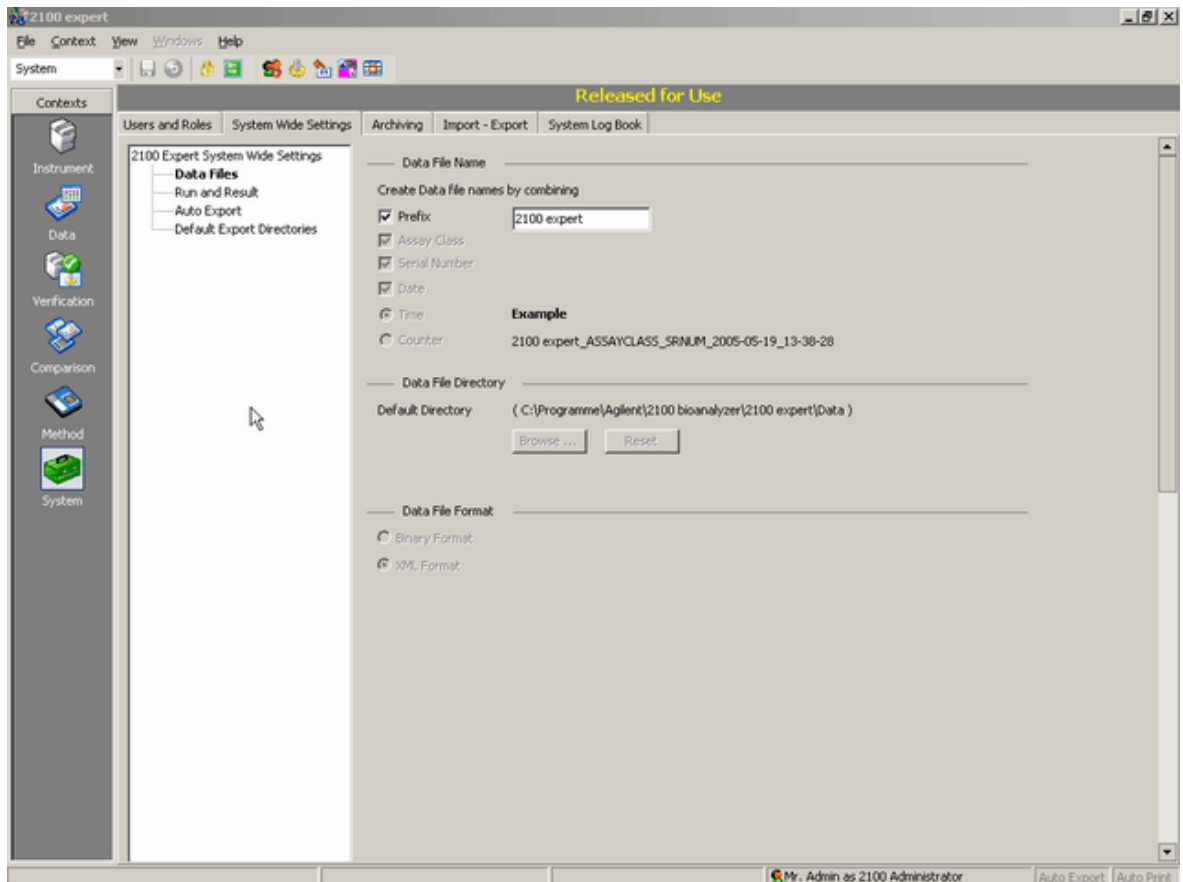

## Closing 2100 Expert Software

- 1 From the **File** menu, select **Exit**.

If a chip run is in progress, the following message appears:

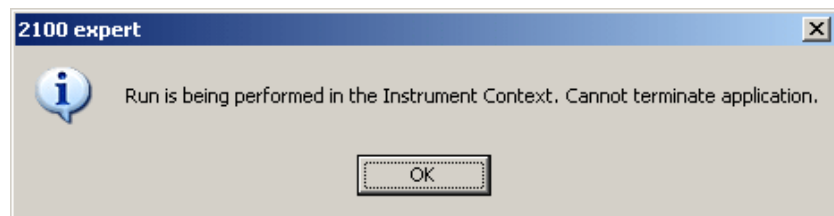

- 2 Click **OK** and wait until the chip run is complete.

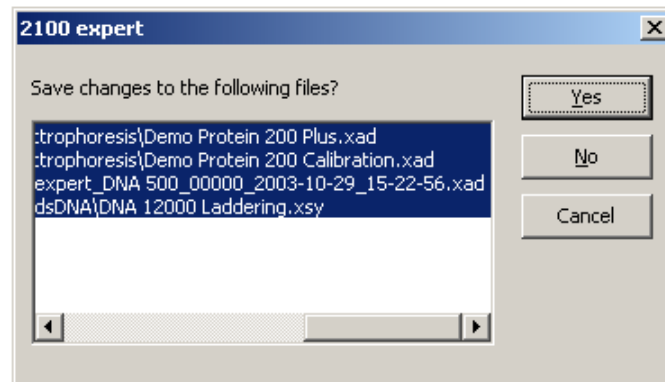

### NOTE

This dialog box may also appear if you try to switch between contexts while there is unsaved data.

- 3 If the currently open file has not yet been saved, 2100 Expert Software asks for your electronic signature in order to save the file.

### HINT

When opening a saved data file later, you can always load earlier versions of the file if required.

After you have confirmed the messages, 2100 Expert Software quits.

## The 2100 Expert Security Pack

The 2100 Expert Software with the Security Pack license provides functionality for

- Access Control (“[Access Control](#)” on page 39)
- Data Integrity (“[Data Integrity](#)” on page 42)
- Handling of Electronic Signatures (“[How to Sign your Work Steps](#)” on page 43)
- Workflow Control (“[Workflow Control](#)” on page 50)

With access control functionality, only authenticated and authorized users can access and modify data, i.e. any electronic record created or managed by 2100 Expert Security Pack. It is part of the concept to guarantee the security and integrity of all analytical data created with the 2100 Bioanalyzer instrument and managed by the 2100 Expert Software on a validated PC system. This data security protects all raw data, methods/assays, and results from unauthorized access. Together with the functionality provided for handling of electronic signatures and workflow management, the security pack renders the 2100 Expert Software compliant to the regulations and guidelines of the Food and Drug Administration (FDA) for electronic records and electronic signature, 21 CFR Part 11.

With the workflow management functions, only dedicated users can perform measurements and create result data. This data must then be reviewed in a way that is configurable, but always requires a 4-eyes principle in order to approve results. The review levels are configurable regarding to who will be allowed to perform them, but also regarding to how many levels of reviews have to be accomplished for a certain method/assay.

## Access Control

The 2100 Expert Security Pack provides configurable access control and user management functionality to ensure that only authorized users can access the software and the measurement data:

- User control (login, access to functionality and data)

Each user must log on to the 2100 Expert Software by entering his/her user name and password. Access to data as well as to functions is only permitted to authenticated and authorized users according to their user roles. Each user is identified and checked for his or her function at all times.

Some program settings (configuration) are specially protected and can only be edited by the 2100 Expert administrators.

- Application lock

If the 2100 Expert Software workplace is not used within a specified amount of time, the screen is automatically locked. In such cases, only authorized users can unlock the computer. During a method workflow, only the current user or a special unlock operator can remove the application lock.

- Windows user accounts

2100 Expert Software deploys and integrates windows operating system technology for the configuration of user and password management. Thus, options of configuration are versatile and also pre-existing configurations can be easily applied to 2100 Expert Software.

### User Role Model

The 2100 Expert user role model ensures that every user is allowed to access only those functions he/she is authorized to use (functional security).

### User Account

The 2100 Administrator takes care of the 2100 Expert Software user accounts. To work with the 2100 Expert Software, you have to log on first (password protected).

## Roles and Access Rights

Depending on your tasks, you are assigned to one or several user roles, for example, administrator, operator, or advanced operator. Rights that are associated with your roles provide access to specific functions of the 2100 Expert Software.

By default, the following roles are used within the 2100 Expert Software:

- **2100 Administrator**

Is responsible for user accounts and roles. Additionally, can perform data export and archiving and can open methods/assays and data files. The 2100 Administrator also has rights to access the secured area with the Windows Explorer for backup and archiving purposes.
- **Backup Operator**

Is responsible for batchwise export and import, archiving and dearchiving, and backup possibilities with external tools. The backup operator also has rights to access the secured area with the Windows Explorer for backup and archiving purposes.
- **Standard Operator**

Can create and run methods/assays and analyze the data, cannot change advanced setpoints nor perform manual integration.
- **Advanced Operator**

Can create and run methods/assays and analyze the data, including changing the advanced setpoints and performing manual integration. Can additionally validate instruments.
- **Validation Operator**

Is responsible for validating the 2100 Bioanalyzer system, usually an Agilent service engineer.
- **2100 Unlock Operator**

Is needed in case of a private lock applied or if another user needs access and the user corresponding to the private lock unexpectedly is not available.
- **2100 Guest**

Merely has got read-only access to methods/assays and data, but no operating functionality.



**Table 2** More specifically, the users with the different roles have access to the following functions

Context	Function	2100 Administrator	Backup Operator	Standard Operator	Advanced Operator	Validation Operator	2100 Unlock Operator	2100 Guest
System	User management	X						
	Archive/de-archive data	X	X					
	Import/export multiple files	X	X		X			
Verif.	Verify system and instruments				X	X		
Method/ Assay	Open method/assay files	X	X	X	X	X	X	X
	Create and modify methods/assays (except advanced setpoints and result flagging rules)			X	X			
	Modify advanced setpoints and result flagging rules				X			
Instr.	Run methods/assays on instruments			X	X			
Data	Open data files	X	X	X	X	X	X	X
	Analyze measurement data (except advanced setpoints and manual integration)			X	X			
	Modify advanced setpoints and use manual integration				X			
General	Read log books	X	X	X	X	X	X	X
	Change password	X	X	X	X	X	X	

In most cases 2100 Expert Software displays all data for reviewing independent of the user role. However, only that functionality is available that is associated with the specific role. Note that a user may have more than one role assigned.

If you have several roles and need to perform a task associated with a role other than your current role, you have to log out and log back in with the other role.

## Data Integrity

2100 Expert Software provides functionality to ensure the integrity of all data:

- Data protection

The measurement data is stored in the restricted area of the file system. It cannot be accessed with the Windows Explorer by ordinary means. This means that viewing files and data with the Windows operating system explorer is restricted.

- Audit trails and log books

User actions in the 2100 Expert Software are logged in so-called audit trails and signature logs. These are records of access-controlled actions and cannot be manually modified. They are subject to data protection and are saved within the data files or with the 2100 Expert system file.

The audit trails and signature logs capture the following actions:

- Service access and all administration activities
- Changes to access rights of users
- Modifications to measurement data
- The logins and logouts of users, as well as failed attempts to log in and opening and closing of sessions
- Additional concepts are provided for
  - Version control to identify original files and to control versioning of file copies
  - Archiving functionality and data access for backup purposes for particular users
  - Disaster recovery

## Handling of Electronic Signatures

All activities such as creating or modifying data must be confirmed by the user with his or her electronic signature to proof their authentication.

To ensure data security, no user can sign two consecutive steps in the workflow. If, for example, one user executes a measurement, another user has to review and approve the results.

The different levels of the review workflow are completed by signing them. Once a user has performed a step (for example, reviewed the results), he/she has to sign it. The data is then released for the next workflow level. Then the next user is responsible for the method and the previous user can no longer reject the step. He/she would have to inform the next user to reject the results.

The complete sequence of steps is documented in the audit trail and the signature log, even if the desired result was not achieved.

### How to Sign your Work Steps

You have performed an action that requires to be signed with your electronic signature such as creating or modifying data.

To sign your work within 2100 Expert Software:

### 3 Looking at 2100 Expert Software The 2100 Expert Security Pack

- 1 If you choose to save the current data or if you try to switch to another file or context, 2100 Expert Software asks for your signature:

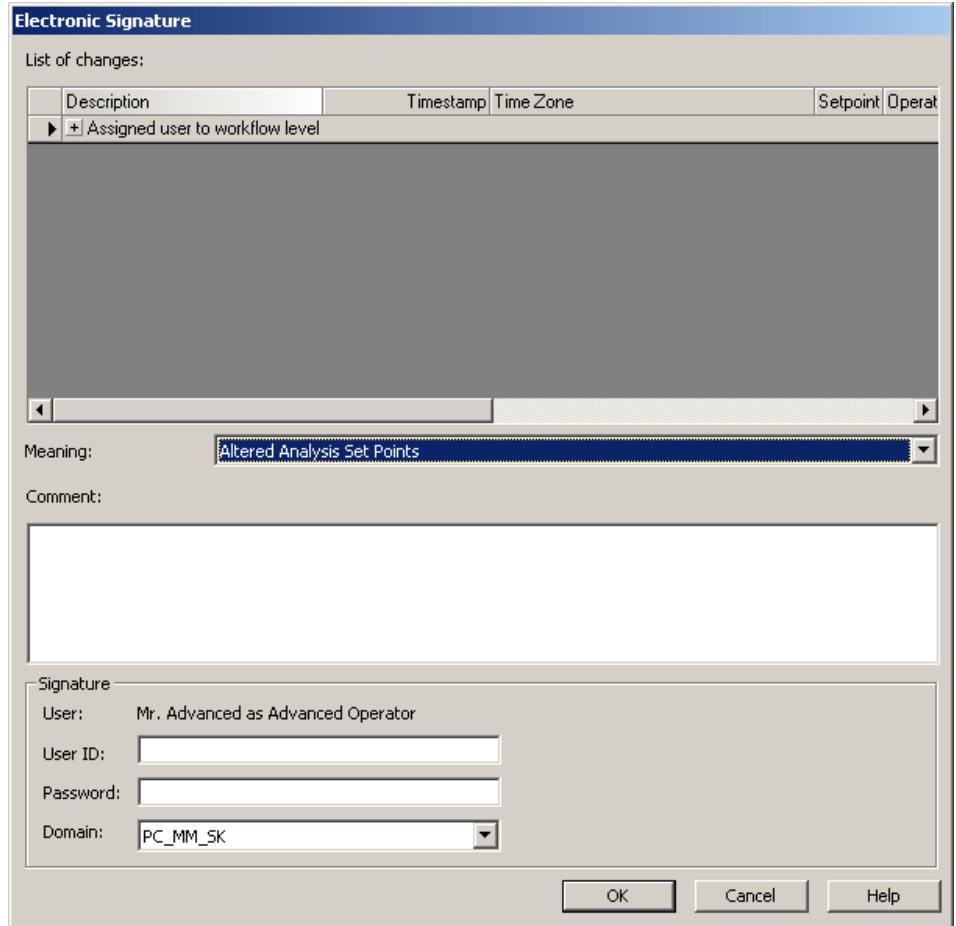

The dialog box is titled "Electronic Signature" and contains the following elements:

- List of changes:** A table with columns: Description, Timestamp, Time Zone, Setpoint, Operat.
- Meaning:** A dropdown menu showing "Altered Analysis Set Points".
- Comment:** A large empty text area.
- Signature:** Fields for User (Mr. Advanced as Advanced Operator), User ID, Password, and Domain (PC\_MM\_SK).
- Buttons:** OK, Cancel, and Help.

Description	Timestamp	Time Zone	Setpoint	Operat
+ Assigned user to workflow level				

- At the top of this dialog, you see the list of changes. Click the plus symbol to expand the sections of the list.

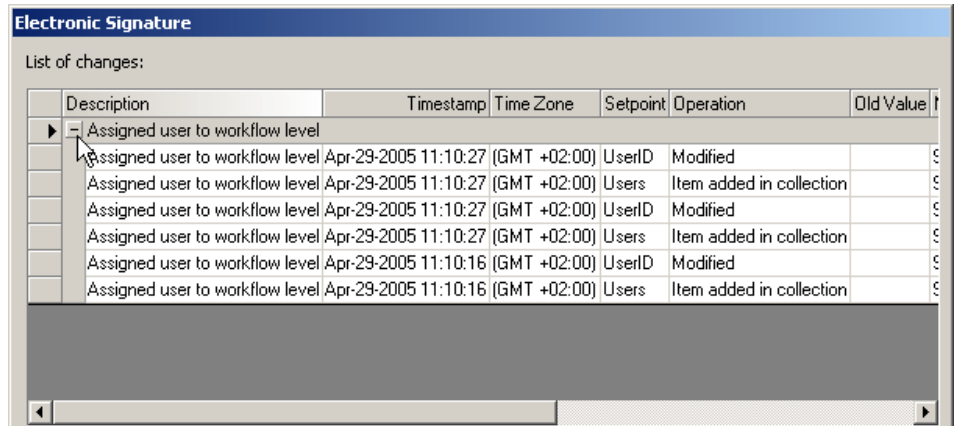

- The **Meaning** field is used to state the main purpose of your modifications. In some cases, however, the meaning is unequivocal and you don't need to select it here. This is, for example, when starting a chip run. Then the meaning is already preselected and cannot be changed.

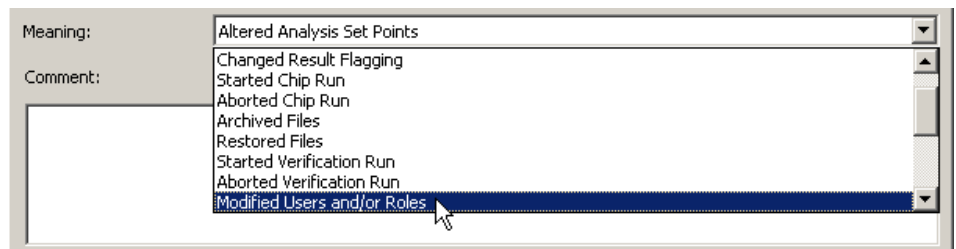

- To specify your intention in more detail, use the **Comment** field.
- Enter your User ID (login name) and your Password in the **Signature** section. Furthermore, the displayed **Domain** name must be correct. This is either the local PC name or the network domain, depending where your **User ID** is defined.
- To finish the electronic signature, click **OK**.

## How to Approve/Reject the Current Workflow Level

With every method, an appropriate workflow must be defined in order to release it for use. This means that one or several users must be explicitly specified to approve the work of each workflow level. When executing a method, these users can then approve the measured results and move the method to the next workflow level.

To approve the current workflow level:

- 1 To review the results, switch to the **Data** context.

As the analyst who was running the method, you now can check the measured results of all samples.

- 2 Samples can be approved from the **Chip Summary** tab table (also in a bulk), or individually in the **Electropherogram** tab.
  - a In the **Approved** column of the sample table, specify for each sample whether the results can be approved or must be rejected.

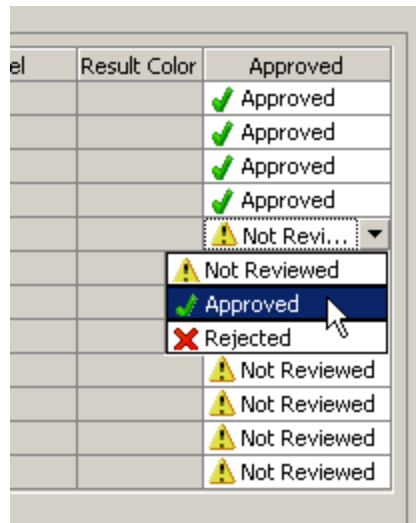

- b Right-click on the sample's electropherogram and select your **Approval** for the sample.

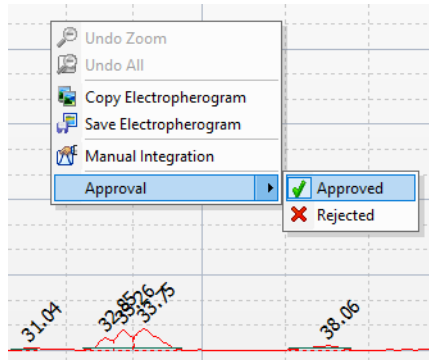

- 3 If all samples are approved, you select **Approve current workflow** from the **Workflow** menu.

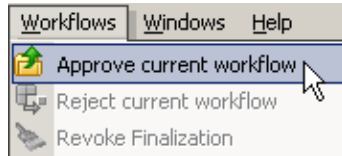

- 4 Confirm your changes to the state of the samples with your electronic signature.

- 5 Additionally, confirm the workflow level approval with your workflow signature.

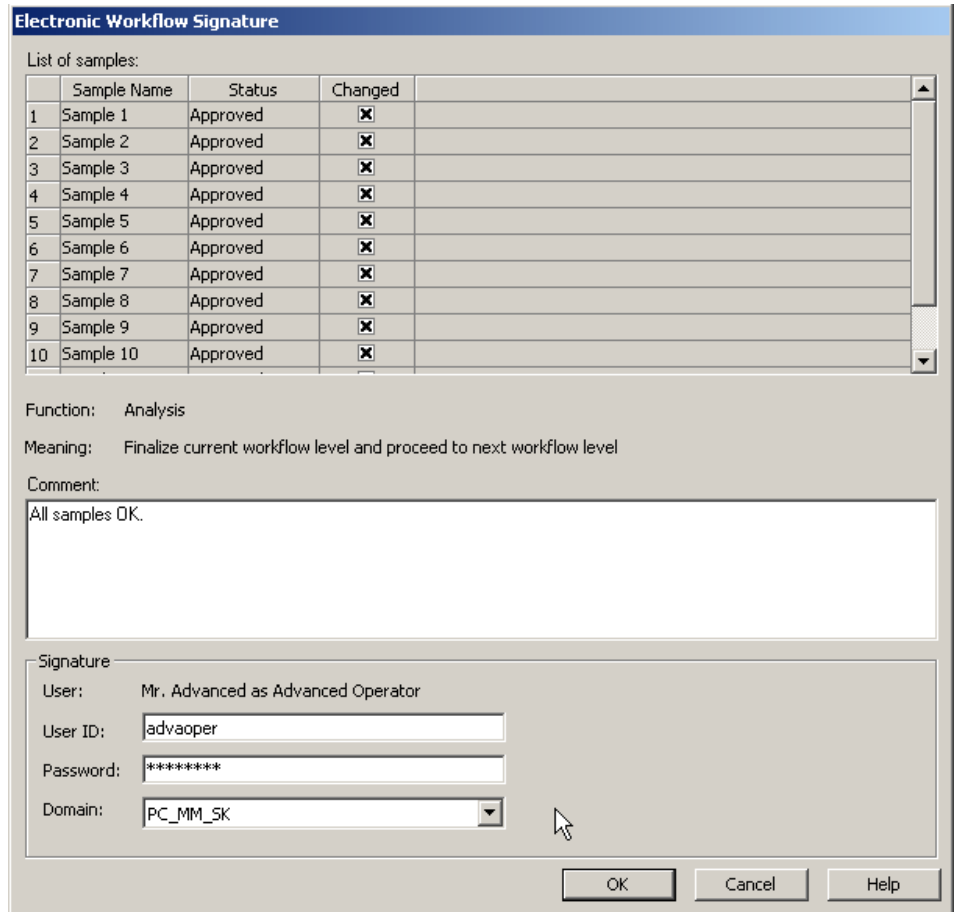

The dialog box titled "Electronic Workflow Signature" contains a table of samples, a function and meaning section, a comment text area, and a signature section with user details and login fields.

	Sample Name	Status	Changed	
1	Sample 1	Approved	<input checked="" type="checkbox"/>	
2	Sample 2	Approved	<input checked="" type="checkbox"/>	
3	Sample 3	Approved	<input checked="" type="checkbox"/>	
4	Sample 4	Approved	<input checked="" type="checkbox"/>	
5	Sample 5	Approved	<input checked="" type="checkbox"/>	
6	Sample 6	Approved	<input checked="" type="checkbox"/>	
7	Sample 7	Approved	<input checked="" type="checkbox"/>	
8	Sample 8	Approved	<input checked="" type="checkbox"/>	
9	Sample 9	Approved	<input checked="" type="checkbox"/>	
10	Sample 10	Approved	<input checked="" type="checkbox"/>	

Function: Analysis  
Meaning: Finalize current workflow level and proceed to next workflow level

Comment:  
All samples OK.

Signature  
User: Mr. Advanced as Advanced Operator  
User ID:   
Password:   
Domain:

OK Cancel Help

The method is moved to the next workflow level (review).

Only the users that are specified in the method for this level are authorized to do the review. The number of required review levels is also specified in the method.

If you are reviewing the method in a later workflow level and the results are not as required, you can also reject the method by selecting **Reject current workflow** from the **Workflow** menu. The method must then be taken care of the users of the previous level again.



If you are assigned to two subsequent workflow levels, you cannot approve both levels. When trying to approve the second subsequent level, the following message appears:

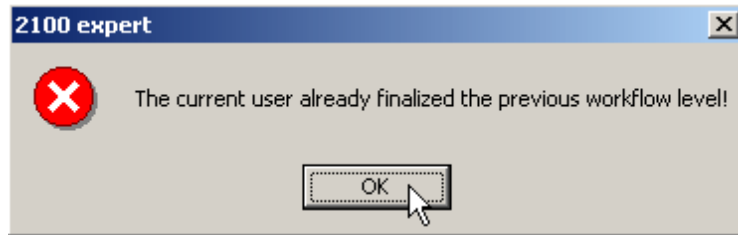

The user doing the final review finalizes the method by approving the final workflow level. However, he/she has the option to revoke this finalization in case errors are observed afterwards. This can also be done from the **Workflow** menu.

## Workflow Control

All measurements follow a determined workflow. This workflow includes steps such as the execution of methods, peer reviews, and the final approval. The workflow also defines that only pre-defined users in certain roles can take these actions and that any other user is restricted from doing so. Every action in the workflow must be signed by the user with an electronic signature, before it can be passed on to the next review/workflow level. The workflow management in particular provides means of reproducibility and traceability for the measurements, thus providing data and result reliability.

For every measurement done with the 2100 Bioanalyzer system, the following workflow must be followed:

**1** Method/Assay setup

Methods/Assays are created from method/assay templates and can be modified as required for a particular measurement, typically done by an advanced operator.

**2** Method execution

The available methods are used to run measurements. This includes the following steps:

- Preparing the required samples, reagents, chip and the instrument
- Entering the required administrative information in the method
- Executing the method

The methods are typically executed by a standard operator.

**3** Analyst review(s)

Every measurement must be evaluated by one of the analyst reviewers. The reviewer decides whether the measurement gets approved (moved to the next workflow level) or rejected (moved one workflow level back).

**4** One or more peer reviews and approval (depending on your system configuration)

Some labs require the approval of several reviewers. The number of required reviews can be specified in the method.

**5** Final review

With the evaluation of the final reviewer, the measurement is finished, in case the evaluation results in an approval.

**6** Exception route

Revoke of the final approval brings back the file into the state, where one of the final reviewers can modify the file and do a changed approval in case of a sample or a setpoint had been accidentally set in a wrong manner and needs to be adjusted before the final state of the document.

This workflow is valid for all methods and measurements and can only be operated in this exact order.

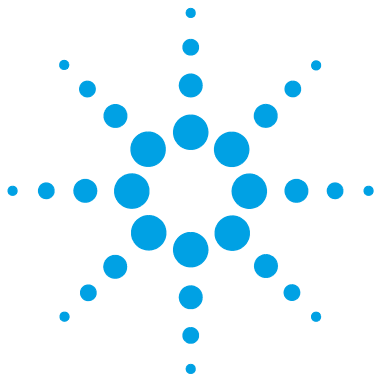

## 4 Running and Evaluating Electrophoretic Methods/Assays

Principles of Nucleic Acid and Protein Analysis on a Chip	53
Preparing and Running an Electrophoretic Method or Assay	57
Selecting an Electrophoretic Method	58
Preparing Samples, Reagents, and Chips for Electrophoretic Methods/Assays	61
Loading the Electrophoresis Chip into the 2100 Bioanalyzer Instrument	63
Running an Electrophoretic Method or Assay	68
Entering Chip and Sample Information	73
Displaying the Measurement Results (Electrophoresis)	75
Cleaning the Electrodes	83
Analyzing and Evaluating the Results of an Electrophoretic Method or Assay	85
Data Analysis: DNA	86
Data Analysis: RNA and CY5-labeled Nucleic Acids	89
The RNA Integrity Number (RIN)	91
Data Analysis: Protein	100
Smear Analysis	106
Changing the Data Analysis	110
Manual Integration	129
Reanalyzing a Chip Data File	138
Comparing Samples from Different Electrophoretic Chip Runs	139
Result Flagging	145
How to Use the Form Mode	148
Color Indication	150
How to Use the Editor Mode	153
Example: Result Flagging	155



## **4 Running and Evaluating Electrophoretic Methods/Assays**

### **The 2100 Expert Security Pack**

This chapter explains how electrophoretic measurements are made using the 2100 Bioanalyzer system, gives detailed descriptions of all steps necessary to run electrophoretic assays, and shows how to analyze and evaluate results using electropherograms and gel-like images.

## Principles of Nucleic Acid and Protein Analysis on a Chip

The electrophoretic methods/assays are based on traditional gel electrophoresis principles that have been transferred to a chip format. The chip format dramatically reduces separation time as well as sample and reagent consumption. The system provides automated sizing and quantification in a digital format. On-chip gel electrophoresis is performed for the analysis of DNA, RNA and proteins.

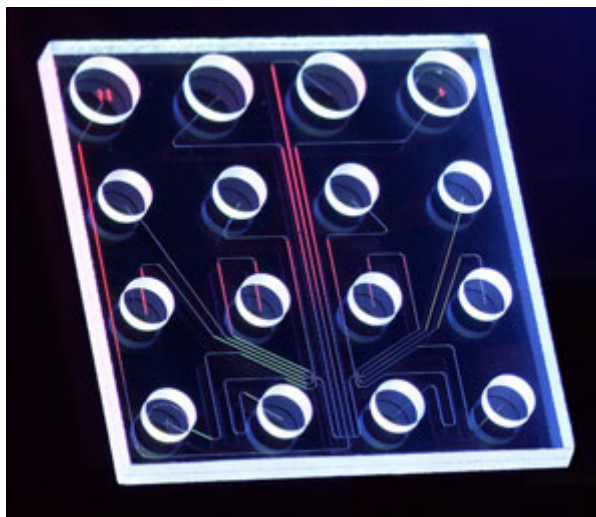

The chip accommodates wells for samples, gel and an external standard (ladder). Micro-channels are fabricated in glass to create interconnected networks among these wells. During chip preparation, the micro-channels are filled with a sieving polymer. Once the wells and channels are filled, the chip becomes an integrated electrical circuit. The 16-pin electrodes of the cartridge are arranged so that they fit into the wells of the chip. Each electrode is connected to an independent power supply that provides maximum control and flexibility. Charged biomolecules like DNA, RNA, or protein/LDS micelles are electrophoretically driven by a voltage gradient—similar to slab gel electrophoresis. Because of a constant mass-to-charge ratio and the presence of a sieving polymer matrix, the molecules are separated by size. Smaller molecules are migrating faster than larger ones. The detection is based on laser-induced fluorescence detection (LIF). Dye molecules intercalate into

DNA or RNA strands or protein/LDS micelles. For some applications proteins, RNA or DNA are covalently labeled with a fluorescent dye before separation. The detection is automatically performed by laser induced fluorescence (LIF) detection. Data is translated into gel-like images (bands) and electropherograms (peaks). With the help of a ladder that contains components of known sizes, a standard curve of migration time versus molecule size is plotted. From the migration times measured for each molecule in the sample, the size is calculated. Depending on the assay, one or two internal markers are run with each of the samples. The markers are internal standards used to align the ladder data with data from the sample. This is necessary to compensate for drift effects that may occur during the course of a chip run.

For all DNA methods/assays, quantitation is done with the help of the upper marker. The area under the upper marker peak is compared with the sample peak areas. Because the concentration of the upper marker is known, the concentration for each sample can be calculated. The same principle for quantification based on the upper marker is also used for the Protein 80 and 230 assays. The quantification of the High Sensitivity Protein 250 assay is based on the external ladder. The area under the ladder is compared with the sum of the sample peak areas. Besides this relative quantification, an absolute quantification is available for all protein methods/assays, using standard proteins.

For RNA methods/assays, quantification is also done based on the ladder as described above. In addition, for total RNA methods, the ribosomal ratio is determined, giving an indication on the integrity of the RNA sample. Additionally, the RNA integrity number (RIN) can be utilized to estimate the integrity of total RNA samples based on the entire electrophoretic trace of the RNA sample, including the presence or absence of degradation products.

The 2100 Expert Software plots fluorescence intensity versus size/migration time and produces an electropherogram for each sample:

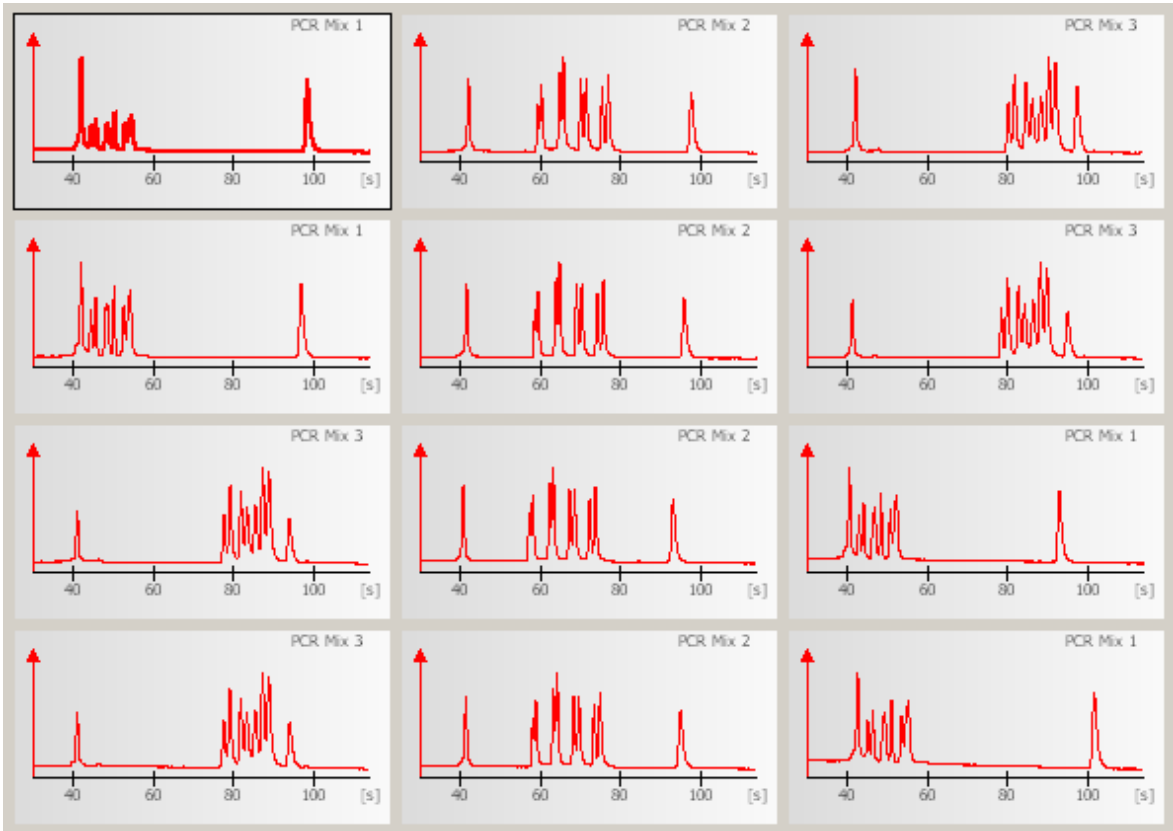

## 4 Running and Evaluating Electrophoretic Methods/Assays

### Principles of Nucleic Acid and Protein Analysis on a Chip

The data can also be displayed as a densitometry plot, creating a gel-like image:

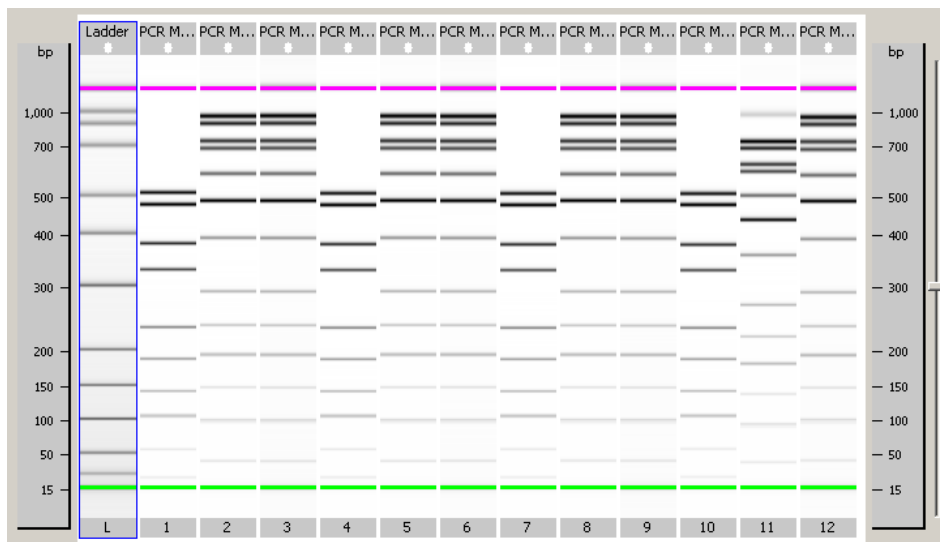



## Preparing and Running an Electrophoretic Method or Assay

### NOTE

The 2100 Expert Security Pack restricts access to data and functionality to users who are logged in with certain roles. See User Role Model for details (“[Access Control](#)” on page 39).

---

### NOTE

Please note that in terms of the 2100 Expert Software, a method resembles an extended assay, which also includes additional administrative data such as operator, instrument, reporting, and workflow settings.

---

### An electrophoretic chip run requires the following steps:

- 1 Switch on the 2100 Bioanalyzer instrument and start the 2100 Expert Software. Details are given in “[Starting the 2100 Expert Software](#)” on page 27
- 2 Select an electrophoretic method/assay.  
See “[Selecting an Electrophoretic Method](#)” on page 58.
- 3 Prepare reagents, chip, and samples.  
See “[Preparing Samples, Reagents, and Chips for Electrophoretic Methods/Assays](#)” on page 61 and the appropriate *Kit Guide*.
- 4 Load the chip into the instrument.  
For details refer to “[Loading the Electrophoresis Chip into the 2100 Bioanalyzer Instrument](#)” on page 63.
- 5 Start the chip run.  
See “[Running an Electrophoretic Method or Assay](#)” on page 68.
- 6 When the chip run has finished, you can:
  - Have a first look at the results (see “[Displaying the Measurement Results \(Electrophoresis\)](#)” on page 75).
  - Document the chip run (see “[Entering Chip and Sample Information](#)” on page 73).
  - Analyze and evaluate the results:
    - See “[Displaying the Measurement Results \(Electrophoresis\)](#)” on page 75.
    - See “[Result Flagging](#)” on page 145.

## Selecting an Electrophoretic Method

### NOTE

The 2100 Expert Security Pack restricts access to data and functionality to users who are logged in with certain roles. See *User Role Model* ( “Access Control” on page 39) for details.

#### To select a method/assay:

- 1 Switch to the **Instrument** context.
- 2 In the **Tree View Panel**, select the instrument you want to use.



In the upper left of the **Instrument** tab, an icon shows the status of the instrument. You should see one of the following icons (lid open/closed), indicating that the 2100 Bioanalyzer instrument is detected by the system:



- 3 If you do not see one of these icons, check that the 2100 Bioanalyzer instrument is switched on and properly connected:
  - Check the **COM port** setting.
  - Make sure the instrument is physically connected to the PC (over the serial interface or the USB-serial adapter).
  - Check the power connection.
  - Check the power switch.

If you need additional help, please refer to the *Agilent 2100 Bioanalyzer System Maintenance and Troubleshooting Guide*.

- 4 Select a method/assay for the chip run.
  - a On the **Instrument** tab, click the **Methods/Assays** button.

OR

Click the **Methods/Assays** menu.

OR

Select File > Open File to Run. This opens a dialog box, allowing you to load either a method/assay (.xsy) or a chip data file (.xad).

Both will open the **Methods/Assays** menu, allowing you to select a method/assay from the submenus.

The type of method/assay you have to select depends on the required measurement and the kit you use to prepare your samples. Details on these methods/assays are described in the Kit Guide.

- 5 Select the desired method/assay, **DNA 1000**, for example.

The method/assay is loaded and its name appears on the **Information Bar**:

DE11700058 - DNA 1000

**NOTE**

After a chip run, the results can be evaluated using parameters from a different electrophoretic chip data file (.xad) of the same method/assay type (DNA 1000 in this example). Refer to [“Importing Data Analysis Setpoint”](#) on page 170.

**NOTE**

The chip data file (.xad) that will be generated as the result of the chip run will be stored the indicated **Destination** folder in the Secured Area.

## 4 Running and Evaluating Electrophoretic Methods/Assays

### Preparing and Running an Electrophoretic Method or Assay

6 Specify an appropriate **Destination** and **File Prefix** for this file.

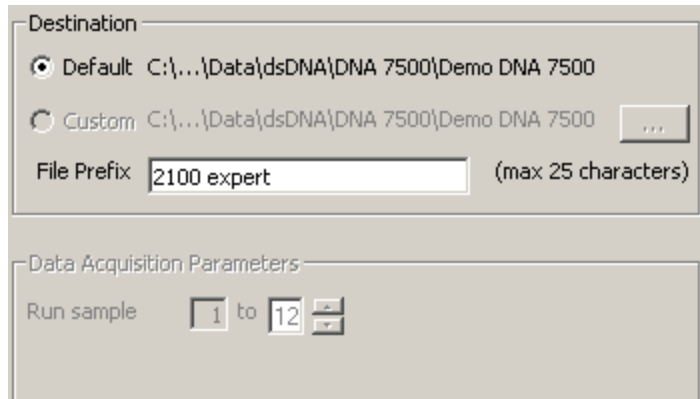

The screenshot shows a software dialog box with two main sections. The top section is titled "Destination" and contains two radio button options. The first option, "Default", is selected and points to the path "C:\...\Data\dsDNA\DNA 7500\Demo DNA 7500". The second option, "Custom", is unselected and points to the same path, with a "..." button to its right. Below these options is a text input field labeled "File Prefix" containing the text "2100 expert" and a note "(max 25 characters)". The bottom section is titled "Data Acquisition Parameters" and contains a "Run sample" label followed by two numeric input fields: the first contains "1" and the second contains "12", with a small arrow icon to the right of the second field.

The total number of samples that can be measured varies with the type of method/assay selected.

#### NOTE

With DNA and RNA Nano assays, 12 samples may be run; with RNA Pico assays, 11 samples may be run; and with Protein assays, the maximum number of samples is 10. When preparing the chip (see [“Preparing Samples, Reagents, and Chips for Electrophoretic Methods/Assays”](#) on page 61), keep in mind that you have to follow the sequence of the sample wells.

When preparing the chip, keep in mind that you have to follow the sequence of the sample wells. For example, if you want to measure only 3 samples, you have to fill the wells 1, 2 and 3 of your chip.

## Preparing Samples, Reagents, and Chips for Electrophoretic Methods/Assays

Before you can load a chip, you have to prepare the samples and reagents. To find out how to prepare the samples and reagents, refer to the various *Kit Guides* available for each Kit. Please refer to these documents for further information and analytical specifications.

In general, preparing an electrophoretic method/assay involves the following steps:

- Check that you have everything that is listed in the appropriate Kit Guide. Be aware that there can be small but important differences between the different methods/assays even for the same type of molecules (for example, between DNA 1000 and DNA 7500 methods/assays).
- Make sure you are familiar with the essential measurement practices (see below next page).
- Before running the first RNA method/assay: decontaminate the electrodes.
- Prepare all the reagent mixtures (for example, the gel-dye mix).
- Load the gel or the gel-dye mix using the priming station.
- Load the DNA/RNA marker solution and buffer.
- Load the destaining solution for protein methods/assays.
- Load the chip with ladder and samples.

### Essential Measurement Practices (Electrophoretic Methods/Assays)

#### WARNING

#### Toxic and hazardous reagents and samples

They may harm your health.

- Wear hand and eye protection and follow good laboratory practices.
- Prepare and handle reagents and samples with care.

#### WARNING

#### Handling dye/DMSO reagent

Kit components contain DMSO. Because the dye binds to nucleic acids, it should be treated as a potential mutagen and used with appropriate care.

- Wear hand and eye protection and follow good laboratory practices when preparing and handling reagents and samples.
- Handle the DMSO stock solutions with particular caution as DMSO is known to facilitate the entry of organic molecules into tissues.

## 4 Running and Evaluating Electrophoretic Methods/Assays

### Preparing and Running an Electrophoretic Method or Assay

#### General:

- Handle and store all reagents according to the instructions given in the *Kit Guides*.
- Avoid sources of dust or other contaminants. Foreign matter in reagents and samples or in the wells of the chip will interfere with method/assay results.
- Always insert the pipette tip to the bottom of the well when dispensing the liquid. Placing the pipette at the edge of the well may lead to poor results.



- Protect all reagents from light. Remove light covers only when pipetting. The dye contained in the reagents decomposes when exposed to light and this reduces signal intensity.
- Use a new syringe and electrode cleaner with each new Kit.
- Do not touch the 2100 Bioanalyzer instrument during a chip run and never place it on a vibrating surface.
- Allow all reagents and samples to equilibrate to room temperature for 30 minutes before use.
- Use loaded chips within 5 minutes. Reagents might evaporate, leading to poor results.
- Keep all reagents and reagent mixes refrigerated at 4°C when not in use.

#### RNA Methods/Assays:

- Always wear gloves when handling RNA, and use RNase-free tips, microfuge tubes and water.
- Thaw RNA samples on ice.
- It is recommended to heat denature all RNA samples and RNA ladder before use (70°C, 2 minutes) and keep them on ice.
- To prevent contamination problems, it is strongly recommended to use a dedicated electrode cartridge for RNA methods/assays. Perform the RNase decontamination procedure for the electrodes on a daily basis before running any methods/assays.
- Always vortex the dye concentrate for 10 seconds before preparing the gel-dye mix and spin down afterwards.

Protein Methods/Assays:

- Upon arrival make aliquots of the sample buffer and ladder with the typical amount required for the daily use and store them at  $-20^{\circ}\text{C}$ . Keep the vial in use at  $4^{\circ}\text{C}$  to avoid freeze-thaw cycles.
- Use 0.5 mL vials to denature samples. Using larger vials may lead to poor results, caused by evaporation.

## Loading the Electrophoresis Chip into the 2100 Bioanalyzer Instrument

For electrophoretic measurements, the electrode cartridge is required.

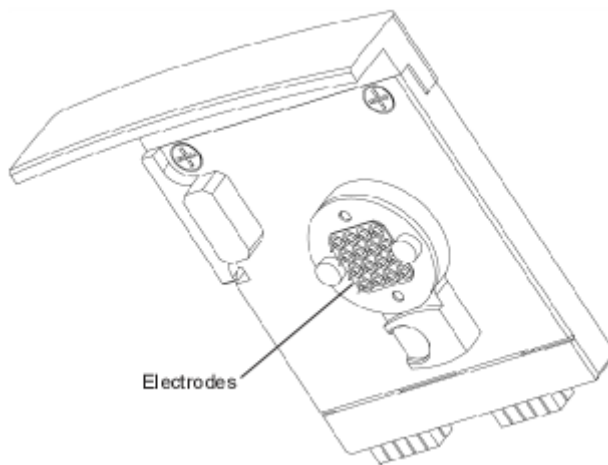

The electrode cartridge contains 16 electrodes that fit into the wells of DNA, RNA, and protein chips. Each electrode in the cartridge has an individual power supply. All electrophoretic methods/assays (DNA, RNA, and protein) require an electrode cartridge. The electrode cartridges will either have an engraved "1" at the front, or will have no engraving at all. Cartridges with a different number are not electrode cartridges.

## Loading Procedures

### If you want to change the electrode cartridge

If you want to change the electrode cartridge, proceed as follows:

- 1 Open the lid and pull down the metal locking lever in the open position as shown in the following figure.

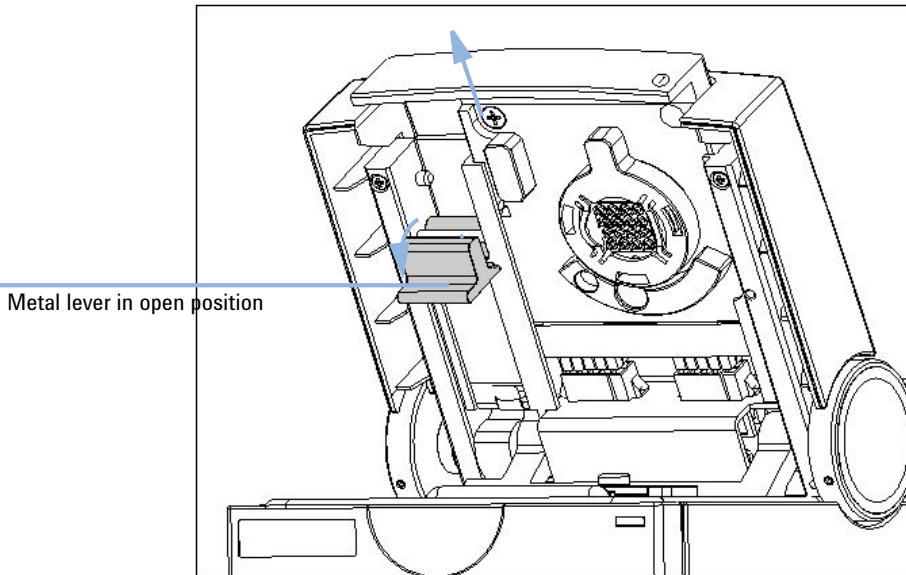

The cartridge is pushed out.

- 2 Gently pull the cartridge out of the lid.

#### NOTE

Store the electrode cartridge in the provided box.



**CAUTION**

Do not touch the electrodes while the cartridge is in the 2100 Bioanalyzer instrument.

The electrodes and the high voltage power supplies can be damaged.

- Be careful with the electrodes and the high voltage power supplies.
- Do not touch the electrodes while the cartridge is in the 2100 Bioanalyzer Instrument.

**3** Slide the new electrode cartridge into the lid as shown below.

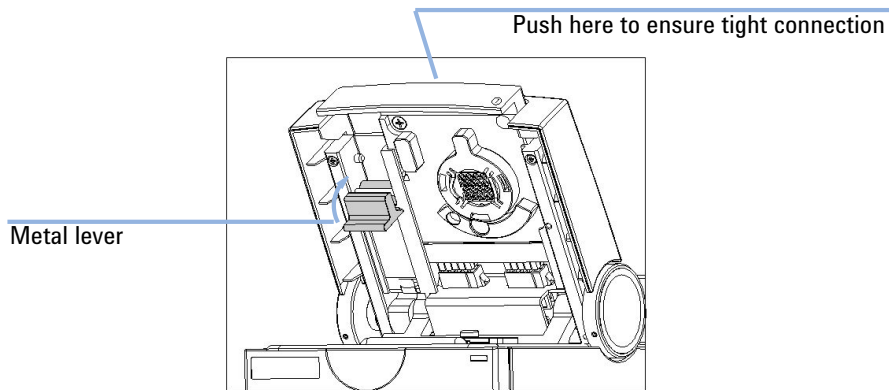

**4** Push the metal front of the cartridge to ensure a tight connection.

**5** Push the metal locking lever into the flat (closed) position.

## 4 Running and Evaluating Electrophoretic Methods/Assays

### Preparing and Running an Electrophoretic Method or Assay

#### To load the prepared chip into the 2100 Bioanalyzer instrument:

- 1 Open the lid and remove any chip.
- 2 Place the prepared chip into the receptacle.  
The chip fits only one way. Do not force it into place.

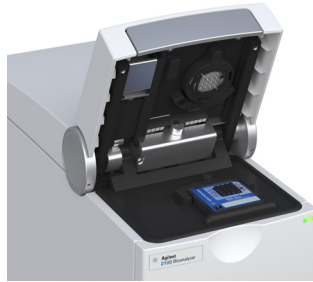

**Figure 2** Electrode cartridge inserted in the instrument (graphic shows an example).

#### CAUTION

Do not force the lid closed.

This can damage the cartridge.

- If the lid does not close without force, check that the cartridge and chip are inserted properly.
- When the software recognizes an inserted chip, the chip is shown on the Instrument tab. If you have closed the lid, and the software has not recognized the chip, verify that the cartridge is properly installed into the instrument. Close the lid.

- 3 Carefully close the lid.

When the chip is detected, the image on the **Instrument** tab changes to a chip.

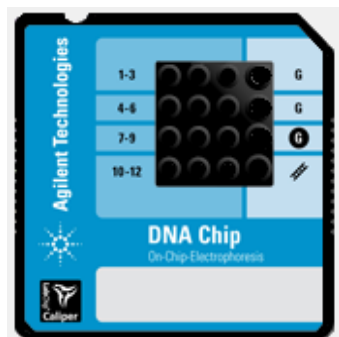

If the chip is not detected, open and close the lid again.

**NOTE**

The displayed image depends on the method/assay selected in the software, not the type of chip inserted. If you would like to run a DNA chip but a protein chip appears, you have selected the wrong method/assay.

---

**NOTE**

If the **AutoRun** option is active, the chip run starts automatically once a chip has been inserted and the lid has been closed.

---

## 4 Running and Evaluating Electrophoretic Methods/Assays

### Preparing and Running an Electrophoretic Method or Assay

## Running an Electrophoretic Method or Assay

### NOTE

You can stop a chip run at any time, for example, if errors occurred or if you are not satisfied with the quality of the measurement results that you can observe during the chip run. See [“Stopping a Chip Run”](#) on page 72.

---

### NOTE

The 2100 Expert Security Pack restricts access to data and functionality to users who are logged in with certain roles. See *User Role Model* ([“Access Control”](#) on page 39) for details.

---

## Starting and Stopping an Electrophoretic Chip Run

### Starting a Chip Run

When you have loaded the chip, you can start the chip run:

- 1 On the **Instrument** tab, click  Start
- 2 To start the chip run, you need to confirm this action with your electronic signature, which will be recorded in the audit trail.

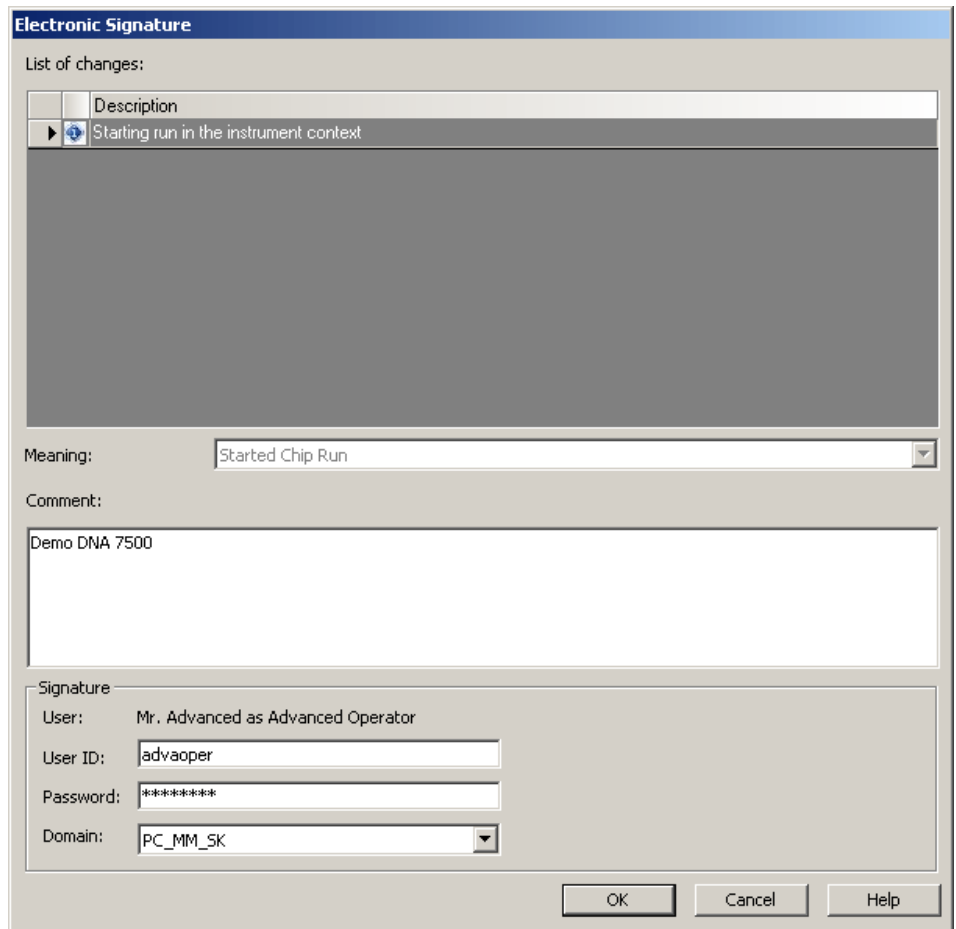

The dialog box is titled "Electronic Signature" and contains the following fields and controls:

- List of changes:** A table with two columns: "Description" and "Starting run in the instrument context".
- Meaning:** A dropdown menu with the selected value "Started Chip Run".
- Comment:** A text area containing the text "Demo DNA 7500".
- Signature:** A section with the following fields:
  - User:** Mr. Advanced as Advanced Operator
  - User ID:** Text input field containing "advvaoper".
  - Password:** Text input field containing "\*\*\*\*\*".
  - Domain:** Dropdown menu with the selected value "PC\_MM\_SK".
- Buttons:** "OK", "Cancel", and "Help" buttons at the bottom right.

## 4 Running and Evaluating Electrophoretic Methods/Assays

### Preparing and Running an Electrophoretic Method or Assay

The chip run starts. The **Raw Signals** sub-tab shows an electropherogram of the currently measured sample. The name of the sample is displayed above the graph. The graph is a “live” plot of the migration time against fluorescence units (raw data, including background fluorescence, for example).

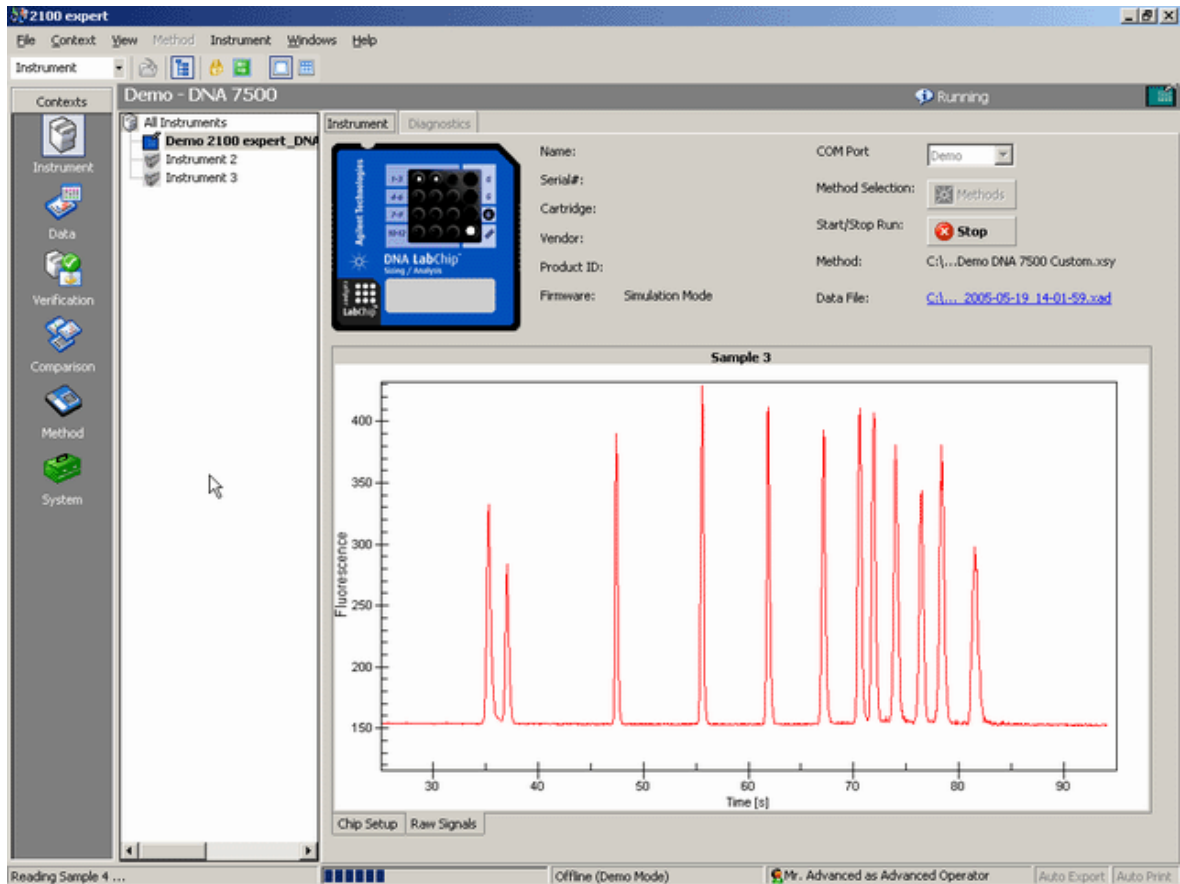

The number of the sample that is currently being measured is indicated on the information bar:



The status bar at the bottom of the screen shows the measurement progress for the chip run and the COM port number used for data acquisition.

**3** During the chip run, you can do the following:

- View the chip data file in the **Data** context e.g. clicking on the name of the **Data File**:

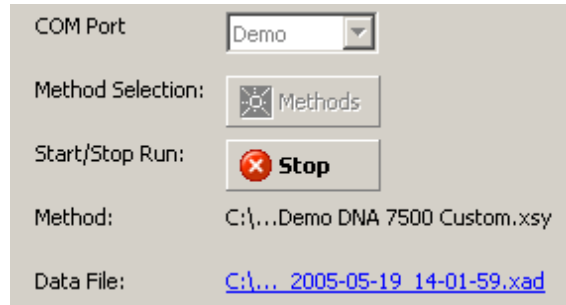

- Switch to any other context. For example, you can evaluate any chip data file in the **Data** context, or compare samples in the **Comparison** context.
- If necessary, abort the chip run by clicking on the **Stop** button. You need to confirm this action with your electronic signature.

All data that was collected up to the stop point will be saved.

**4** After the chip run is completed, you can:

- Switch to the **Data** context, where you can view, analyze, and evaluate the results of your chip run (see “[Displaying the Measurement Results \(Electrophoresis\)](#)” on page 75 and “[Analyzing and Evaluating the Results of an Electrophoretic Method or Assay](#)” on page 85).
- Stay in the **Instrument** context and start a new method/assay, for example.

## 4 Running and Evaluating Electrophoretic Methods/Assays

### Preparing and Running an Electrophoretic Method or Assay

#### Stopping a Chip Run

You can stop a chip run at any time, for example,

- if the quality of the measurement results does not meet your expectations,
- if, for example, after three samples you already have the information you desired and you want to start another chip run.

To stop the method/assay:

#### NOTE

You cannot resume a stopped chip run.

#### NOTE

If you stop a chip run, automatic export (see “Exporting Chip Run Data Automatically” on page 176) and automatic print (see “How to Turn on and Configure Automatic Printing of Chip Run Reports” on page 185) does not take place.

1 Click the  button.

OR

From the **Instrument** menu, select **Stop**.

The following message appears:

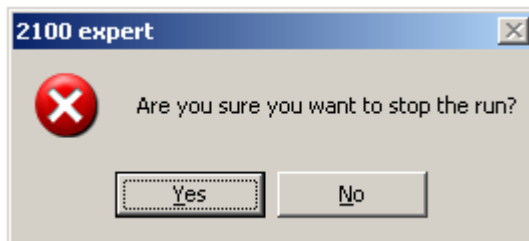

#### NOTE

Data acquisition of the current sample will be aborted.

b Click **Yes** to stop the chip run.



- 2 When the chip run is aborted, you can:
  - Switch to the **Data** context, where you can view, analyze, and evaluate the results (if any) of your chip run (see “[Displaying the Measurement Results \(Electrophoresis\)](#)” on page 75 and “[Analyzing and Evaluating the Results of an Electrophoretic Method or Assay](#)” on page 85).
  - Stay in the **Instrument** context, where you can start the next chip run.

## Entering Chip and Sample Information

### NOTE

The 2100 Expert Security Pack restricts access to data and functionality to users who are logged in with certain roles. See *User Role Model* (“[Access Control](#)” on page 39) for details.

---

**Before and after a chip run, you can document the run by entering information on chip and samples.**

- 1 In the **Data** context, select the **Chip Summary** tab.
- 2 On the **Sample Information** sub-tab, you can enter or modify additional information such as sample names and comments. On the **Study Information** sub-tab, you can enter information such as the name of the current study, the laboratory location, and the experimenter, for example.

## 4 Running and Evaluating Electrophoretic Methods/Assays

### Preparing and Running an Electrophoretic Method or Assay

General Properties Assay Properties **Chip Summary** Gel Electropherogram Result Flagging Log Book

Data File : 2100 expert\_DNA 7500\_00000\_2005-05-19\_14-01-59.xad  
 Location : C:\...2100 expert\SecuredArea\Data\dsDNA\DNA 7500\Demo DNA 7500 Custom  
 Created : Mai 19, 2005 14:02:05  
 Modified : Mai 19, 2005 15:03:38  
 Software : Created by version B.02.01.SI211, modified by B.02.01.SI211  
 File Version : 3 (Latest version)

Sample Name	Sample Comment	Rest. Digest	Status	Observation	Result Label	Result Color	Approved
1 PCR Mix 1	25, 35, 50, 53, 70, ...	<input type="checkbox"/>	✓				⚠ Not Reviewed
2 PCR Mix 2	150, 158, 200, 210...	<input type="checkbox"/>	✓				⚠ Not Reviewed
3 PCR Mix 3	500, 550, 600, 650...	<input type="checkbox"/>	✓				⚠ Not Reviewed
4 PCR Mix 1	25, 35, 50, 53, 70, ...	<input type="checkbox"/>	✓				⚠ Not Reviewed
5 PCR Mix 2	150, 158, 200, 210...	<input type="checkbox"/>	✓				⚠ Not Reviewed
6 PCR Mix 3	500, 550, 600, 650...	<input type="checkbox"/>	✓				⚠ Not Reviewed
7 PCR Mix 1	25, 35, 50, 53, 70, ...	<input type="checkbox"/>	✓				⚠ Not Reviewed
8 PCR Mix 2	150, 158, 200, 210...	<input type="checkbox"/>	✓				⚠ Not Reviewed
9 PCR Mix 3	500, 550, 600, 650...	<input type="checkbox"/>	✓				⚠ Not Reviewed
10 PCR Mix 1	25, 35, 50, 53, 70, ...	<input type="checkbox"/>	✓				⚠ Not Reviewed
11 PCR Mix 2	150, 158, 200, 210...	<input type="checkbox"/>	✓				⚠ Not Reviewed
▶ PCR Mix 3	500, 550, 600, 650...	<input type="checkbox"/>	✓				⚠ Not Reviewed

Chip Lot # 223 Reagent Kit Lot # 29

Chip Comments :  
 prepared by laura

Sample Information Instrument Information Standard Curve

Import... Export...

For details on all input fields, refer to **Chip Summary** tab.

#### NOTE

You may find some input fields already filled in, because chip, sample, and study information are taken over from the base method/assay or chip data file or sample information was already entered in the Instrument context.

**3** From the **File** menu, select **Save**.

#### HINT

You can import chip, sample, and study information from .txt or .csv files. This is especially helpful and time-saving, if you already have documented a similar chip run in another chip data file. Refer to [“Importing Chip and Sample Information”](#) on page 171 for details.

## Displaying the Measurement Results (Electrophoresis)

### NOTE

The 2100 Expert Security Pack restricts access to data and functionality to users who are logged in with certain roles. See *User Role Model* (“Access Control” on page 39) for details.

You can view the measurement results of an electrophoretic chip run as electropherograms or gel-like images.

- You can display the electropherograms either one sample at a time, or all samples at the same time to get an overview of the chip run, for example, to see the progress of a reaction. See “How to Switch Between Single View and Grid View” on page 75.
- You can navigate through the samples. See “How to Navigate Through the Samples” on page 76.
- You can change the display of electropherograms and gel-like images to make details better visible. See “How to Change the Display of Electropherograms and Gel-like Images” on page 77.

### How to Switch Between Single View and Grid View

To switch between single view and grid view:

- 1 From the **Electropherogram** menu, select **View Single Sample** or **View All Samples**.

OR

Click the **View Single Sample**  or **View All Samples**  button on the Electropherogram toolbar.

OR

Click the **All Samples** entry in the **Tree View Panel** to switch to the grid view, or any sample name to switch to the single view.

OR

Double-click any electropherogram in the grid view to switch to single view:

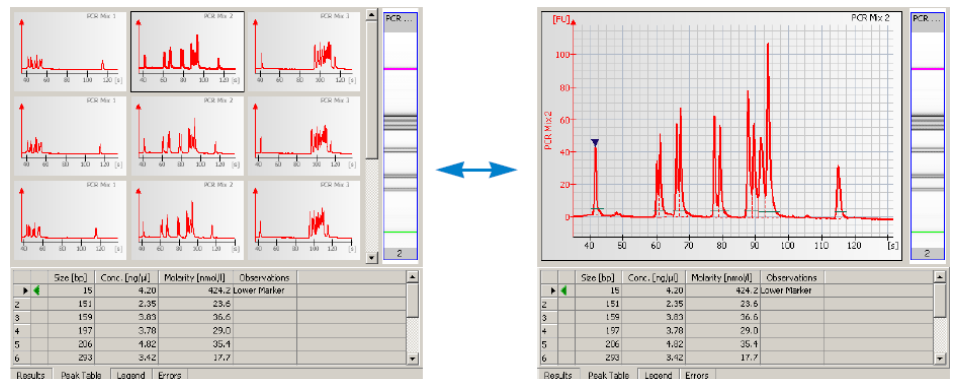

## How to Navigate Through the Samples

At any time—even during a chip run—you can scroll through all samples—either in electropherogram or gel view.

### Navigation Procedures



#### To navigate through samples using the Lower Panel:

- 1 If the lower panel is not visible, select **View > Lower panel**.  
The lower panel appears in the lower left corner.
- 2 **Electropherogram view:** Click any lane of the small gel image.  
OR  
**Gel view:** Click any well on the chip icon.

#### To navigate through samples using the TreeView Panel:

- 1 If the tree view is not visible, select **View > Tree View**.  
The tree view panel appears to the left of the tabs, and shows all chip data and method/assay files as nodes.
- 2 Click any sample name.  
**Electropherogram view:** the electropherogram of the selected sample is shown in single view  
**Gel view:** the lane of the gel-like image corresponding to the selected sample is highlighted.

#### To browse through samples:

- 1 From the **Electropherogram** or **Gel** menu, select **Next Sample** or **Previous Sample**.  
OR  
Click the **Next Sample**  or **Previous Sample**  button in the electropherogram or gel toolbar.

#### To switch between electropherogram and gel view

- 1 Click the **Electropherogram** or **Gel** tab to display the results of the selected sample as an electropherogram or as a gel-like image.

## How to Change the Display of Electropherograms and Gel-like Images

It is possible to change the display of electropherograms and gel-like images.

In electropherograms and gel-like images you can:

- zoom (enlarge or reduce using the mouse) the graphs to display details, for example.

In electropherograms, you can additionally:

- change the peak labeling, e.g. peak size
- switch the x-axis description between size and migration time
- switch enhanced RNA view on and off
- show data points.
- pan and scale the graph using the mouse.
- change the background from a gray-to-white gradient to white.
- add a grid to the electropherograms.

In gel-like images, you can additionally:

- change the exposure
- change the gel color.
- change order of gel lanes in gel like images.

## How to change the display

### How to zoom into an electropherogram

- 1 From the **Electropherogram** menu, select **Graph Mode > Zoom** (default setting).
- 2 Position the mouse pointer in the electropherogram.
- 3 Click and hold down the left mouse button.

The mouse pointer changes its shape to a magnifying glass:



- 4 Drag the mouse.

A rectangle shows the part of the an electropherogram to be enlarged.

- 5 Release the mouse button.

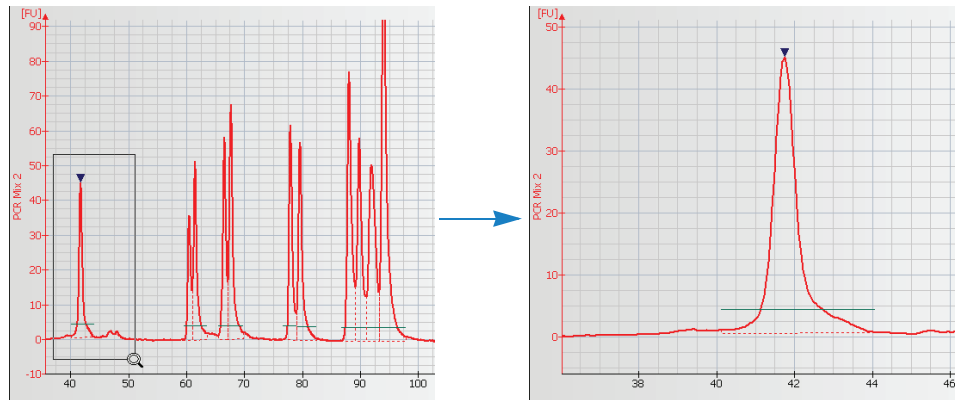



### How to pan and scale an electropherogram

- 1 From the **Electropherogram** menu, select **Graph Mode > Pan** or **Scale**.
- 2 Position the mouse pointer in the electropherogram.
- 3 Click and hold down the left mouse button.

The mouse pointer changes its shape to a double-arrow or to a double crosshair.

- 4 Drag the mouse.

As you drag the mouse, the electropherogram curve moves in the drag direction (**Pan** mode), or the scales of the X and/or Y axes change (**Scale** mode).

- 5 Release the mouse button.
  - a You can perform several zoom, pan and scale steps in a row.
  - b To undo the last zoom, pan, or scale step: Click the **Undo Zoom**  button or double-click in the electropherogram.
  - c To undo all zoom, pan, and scale steps: Click the **Undo All**  button.
  - d To remove the gray-to-white gradient from the background of an electropherogram: From the **Electropherogram** menu, select **Show Gradient**. The color gradient disappears and a white background is displayed.
  - e To show/hide the grid lines on an electropherogram: From the **Electropherogram** menu, select **Show Grid**.

**NOTE**

You can perform several zoom, pan and scale steps in a row.

---

### How to undo the last zoom, pan, or scale step

- 1 Click the **Undo Zoom**  button or double-click in the electropherogram.

### How to undo all zoom, pan, and scale steps

- 1 Click the **Undo All**  button:

### How to display data points in an electropherogram:

- 1 From the **Electropherogram** menu, select **Show Data Points** or click the  button in the toolbar.

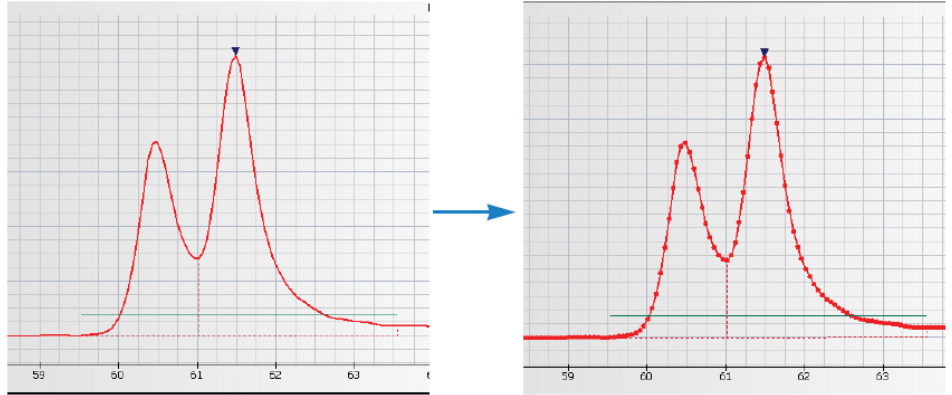

Data points used to generate the graph are now shown as bullets. Data points are 0.05 seconds apart.

### How to change the peak labeling or remove the labeling:

- 1 Click on the  dropdown menus in the toolbar.

### How to switch the x-axis between size or migration time:

- 1 Click on the  button in the toolbar.

### How to switch the enhanced RNA view on and off:

- 1 Click on the  button in the toolbar.

The greyscale of the gel image is recalculated while excluding the marker peak intensity. This will enhance band visibility for faint samples with low fluorescence intensity.



### How to remove the gray-to-white gradient from the background of an electropherogram

- 1 From the **Electropherogram** menu, select **Show Gradient**.  
The color gradient disappears and a white background is displayed.

### How to show/hide the grid lines on an electropherogram

- 1 From the **Electropherogram** menu, select **Show Grid**.

### How to zoom into a gel-like image:

- 1 Position the mouse pointer in the gel.
- 2 Click and hold down the left mouse button.

The mouse pointer changes its shape to a magnifying glass  and a horizontal line appears.

A second horizontal line appears showing the part of the gel to be enlarged.

- 3 Release the mouse button.

### You can perform several zoom steps in a row.

#### To undo the last zoom step:

- 1 Click the **Undo Zoom** button  or  
OR  
double-click in the gel.

#### To undo all zoom steps:

- 1 Click the **Undo All** button .

## 4 Running and Evaluating Electrophoretic Methods/Assays

### Preparing and Running an Electrophoretic Method or Assay

#### How to change the order of the gel lanes:

- 1 Position the mouse pointer on top of a gel lane.  
The mouse pointer changes its shape to a hand.
- 2 Click and hold down the left mouse button.
- 3 Drag the mouse left or right.  
The mouse pointer changes its shape to a pointing hand and a vertical line appears.
- 4 Release the mouse button.  
The lane is inserted in the new position.

#### How to switch between displaying sizes or migration time [sec]:

- 1 Select **Gel > Show Sizes** or  
OR  
click on the **Show Sizes** button  in the toolbar.

#### How to change the exposure of the gel:

- 1 Move the exposure slider right to the gel up and down to change the "exposure" of the gel.

#### How to change the gel color:

- 1 Select **Gel > Gel Color** or  
OR  
click on the **Gel Color** button  in the toolbar and select a color scheme from the list.

## Cleaning the Electrodes

When the method/assay is complete, remove the used chip from the instrument and dispose of it according to the guidelines established by your laboratory safety officer. Remove the chip quickly to prevent a buildup of residues from the solutions on the electrodes.

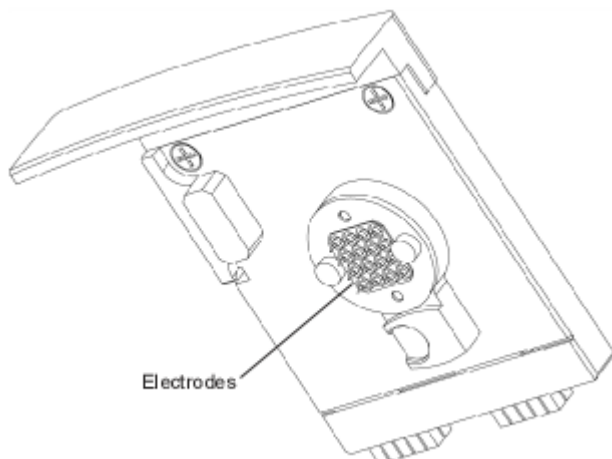

Then perform the cleaning procedure to ensure that the electrodes are clean (i.e., no residues left from the previous method/assay). The cleaning procedures are described in detail in the appropriate *Kit Guide* and in the *Agilent 2100 Bioanalyzer System Maintenance and Troubleshooting Guide*.

## 4 Running and Evaluating Electrophoretic Methods/Assays

### Preparing and Running an Electrophoretic Method or Assay

#### Good Practices

##### CAUTION

Electronic Discharge

Electrostatic discharge could damage the high-voltage power supplies.

- Always use the electrode cleaner for cleaning the electrodes.
  - Never use a cloth to clean the electrodes.
- 

##### CAUTION

Damage of power supply by wet electrodes

Wet electrodes can cause severe damage to the on-board high voltage power supplies.

- Always make sure the electrodes are dry before inserting them into the 2100 Bioanalyzer instrument again.
- 

- 1 Empty and refill the electrode cleaner at regular intervals (e.g., every five methods/assays).

The electrode cleaner can be used for 25 methods/assays.

## Analyzing and Evaluating the Results of an Electrophoretic Method or Assay

The purpose of electrophoretic methods/assays is to separate sample components and determine their size, concentration, purity, or molarity. Results for a particular sample are calculated after all data for that sample has been read.

The steps in data analysis differ depending on the type of method/assay in use:

- [“Data Analysis: DNA”](#) on page 86
- [“Data Analysis: RNA and CY5-labeled Nucleic Acids”](#) on page 89
- [“The RNA Integrity Number \(RIN\)”](#) on page 91
- [“The data analysis process for protein methods/assays consists of the following steps:”](#) on page 100
- [“Smear Analysis”](#) on page 106

Further steps in analysis are:

- [“Changing the Data Analysis”](#) on page 110
- [“Manual Integration”](#) on page 129
- [“Reanalyzing a Chip Data File”](#) on page 138
- [“Comparing Samples from Different Electrophoretic Chip Runs”](#) on page 139
- [“How to Use the Form Mode”](#) on page 148

### NOTE

The 2100 Expert Security Pack restricts access to data and functionality to users who are logged in with certain roles. See *User Role Model* ([“Access Control”](#) on page 39) for details.

## Data Analysis: DNA

- 1 Raw data is read and stored by the system for all individual samples.
- 2 The data is filtered and the resulting electropherograms are plotted. You can change the settings of the data analysis after the run and reanalyze your data.
- 3 Peaks are identified and tabulated by peak ID. You can change the settings of the peak find algorithm and reanalyze the data after the run has finished. (Note that peak find settings can be changed for all or only certain samples.)
- 4 A sizing ladder (see the following example electropherogram), which is a mixture of DNA fragments of known sizes, is run first from the ladder well. The concentrations (ng/μL) and sizes (bp) of the individual fragments are preset in the method/assay and cannot be changed.

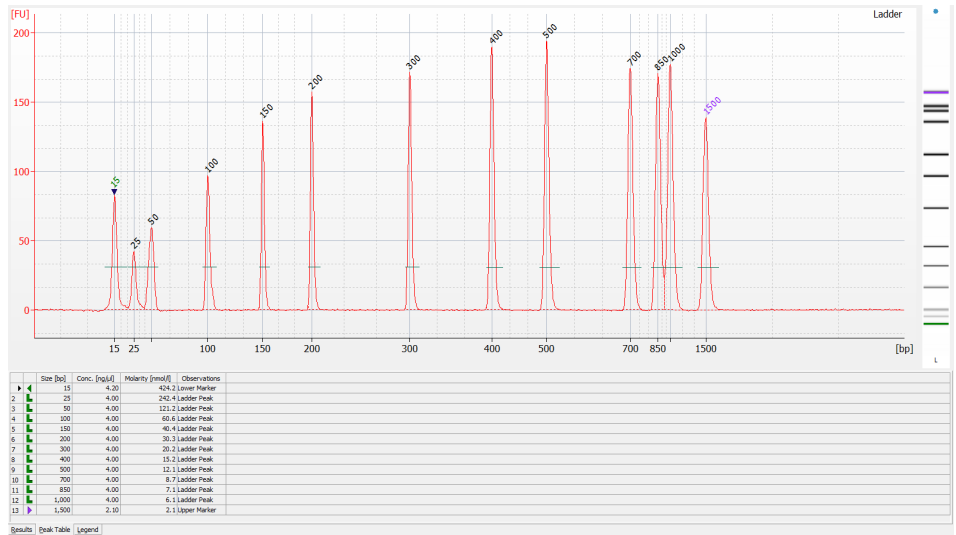

- 5 A standard curve of migration time versus DNA fragment size is plotted from the DNA sizing ladder by interpolation between the individual data

points. The standard curve derived from the data of the ladder well should resemble the one shown below.

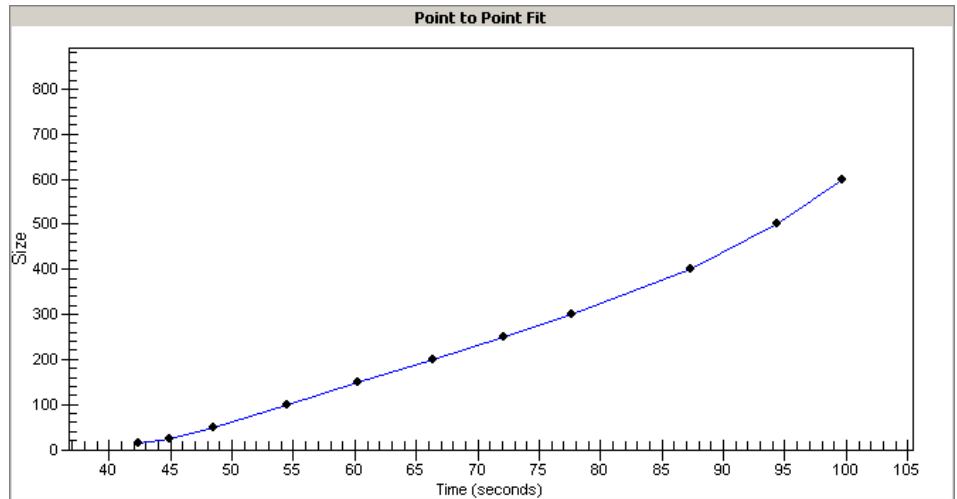

- 6** Two DNA fragments, the lower and upper marker, are run with each of the samples, bracketing the DNA sizing range. The markers are internal standards used to align the ladder data with data from the sample wells. The figure below shows an example of assigned marker peaks in a sample well.

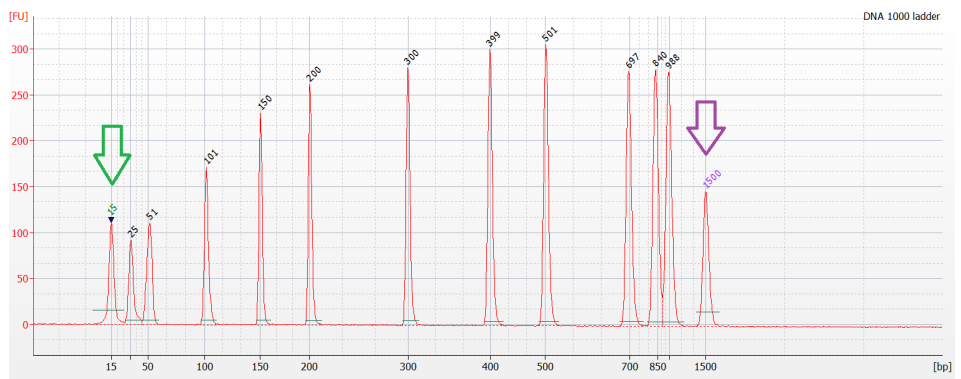

**NOTE**

The software performs alignment by default. Turning automatic data analysis off suspends data analysis until you turn it on again.

## 4 Running and Evaluating Electrophoretic Methods/Assays

### Analyzing and Evaluating the Results of an Electrophoretic Method or Assay

- 7 The standard curve, in conjunction with the internal markers, is used to calculate DNA fragment sizes for each sample from the migration times measured.
- 8 To calculate the concentration of the individual DNA fragments in all samples, the upper marker, in conjunction with a method/assay-specific concentration against base-pair size calibration curve, is applied to the individual sample peaks in all sample wells.

#### NOTE

The software allows you to redefine the peaks chosen as upper and lower markers. A change in marker selection will cause quantitative changes in the calibration procedure, and therefore in the entire data evaluation.

- 9 If the check box **Rest. Digest** on the **Chip Summary Tab** is enabled, the 2100 Expert Software flags peaks that may have co-migrated:

	Size [bp]	Conc. [ng/ $\mu$ l]	Molarity [nmol/l]	Observations
1	15	4.20	424.2	Lower Marker
2	22	1.71	116.6	Possible Co-Migration of 4 Peaks
3	55	1.31	35.8	
4	104	4.22	61.3	Possible Co-Migration of 2 Peaks
5	141	3.19	34.4	
6	187	3.87	31.5	
7	235	4.74	30.6	
8	330	6.81	31.3	
9	381	7.99	31.8	
10	476	10.34	32.9	
11	512	9.31	27.6	
12	1,500	2.10	2.1	Upper Marker

Results Peak Table Legend Errors

Since it is assumed that the molarity of all the fragments in a restriction digest should be the same, any peaks or clusters having a molarity that is significantly larger than the rest are flagged as potentially co-migrating peaks, allowing you to examine them in more detail.



## Data Analysis: RNA and CY5-labeled Nucleic Acids

- 1 Raw data is read and stored by the system for all individual samples.
- 2 The data is filtered and the resulting electropherograms are plotted. You can change the settings of the data analysis after the run and reanalyze your data.
- 3 Peaks are identified and tabulated by peak ID. Fragments, such as ribosomal RNA, are also tabulated. You can change the settings of the peak find algorithm for any or all samples and reanalyze the data.
- 4 An RNA ladder (containing a mixture of RNA of known concentration) is run first (see the electropherogram below). The amount and individual sizes are preset in the assay and cannot be changed.

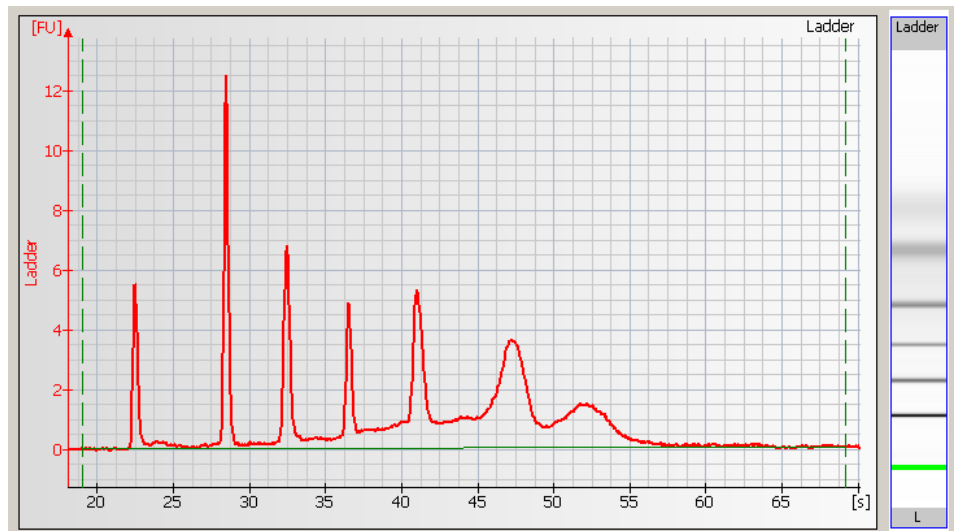

Electropherogram of RNA Nano 6000 Ladder

- 5 The lower marker is run as internal standard with each of the samples and is used to align the ladder with the samples.

### NOTE

Peak ratios for the RNA ladder may vary from one batch of RNA 6000 ladder to the next. Method/assay performance will not be affected by this variation.

## 4 Running and Evaluating Electrophoretic Methods/Assays

### Analyzing and Evaluating the Results of an Electrophoretic Method or Assay

- For the Eukaryote or Prokaryote Total RNA, the ribosomal RNA fragments (either 18S and 28S for eukaryotic RNA or 16S and 23S for prokaryotic RNA) are detected and displayed in the Fragment Table sub-tab. After detection, the ratio of the fragment areas is calculated and displayed in the Results sub-tab.

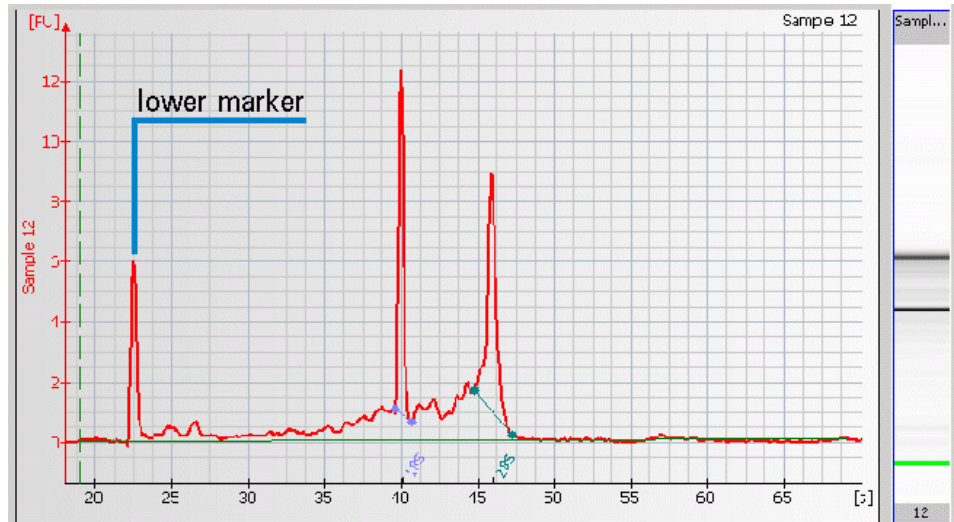

- For the mRNA method/assay, the ribosomal RNA, if present, is detected and displayed in the Fragment Table sub-tab. The ribosomal RNA contamination is calculated and displayed in the Results sub-tab.
- The RNA integrity number is automatically determined and displayed in the Results sub-tab and below the gel-like image.
- To calculate the concentration of the RNA, the area under the entire RNA electropherogram is determined. The ladder, which provides the concentration/area ratio, is applied to transform the area values into concentration values.
- For the small RNA small and miRNA regions are determined and average size, size distribution, concentration and % of total are displayed in the Region Table sub-tab.
- For the Small RNA method/assay, the small RNA and miRNA concentration and the miRNA/small RNA ratio [%] is calculated and displayed in the Results sub-tab.

## Alignment of RNA Samples

The marker solution that is part of each RNA kit, contains a 50 bp DNA fragment. This fragment is used as lower marker to align all samples.

By default the RNA alignment and the subtraction of the lower marker are enabled for RNA Nano methods/assays.

The marker is displayed as the first peak in the electropherogram.

## The RNA Integrity Number (RIN)

The RNA integrity number (RIN) is a tool designed to help scientists estimate the integrity of total RNA samples. The RIN extension automatically assigns an integrity number to a eukaryote total RNA sample analyzed on the 2100 Bioanalyzer system. Using this tool, sample integrity is no longer determined by the ratio of the ribosomal bands alone, but by the entire electrophoretic trace of the RNA sample, including the presence or absence of degradation products. In this way, interpretation of an electropherogram is facilitated, comparison of samples is enabled and repeatability of experiments is ensured.

### Scope

What the RIN can do:

- Obtain an assessment of the integrity of RNA.
- Directly compare RNA samples (e.g. before and after shipment, compare integrity of same tissue across different labs, etc.).
- Ensure repeatability of experiments (e.g. if RIN shows a given value and is suitable for microarray experiments, then the RIN of the same value can *always* be used for microarray experiments given that the same organism/tissue/extraction method/assay was used).

What it *cannot* do:

- Tell a scientist ahead of time whether an experiment will work or not if no prior verification was done (e.g. RIN of 5 might not work for microarray experiments, but might work well for an appropriate RT-PCR experiment. Also, an RIN that might be good for a 3' amplification might not work for a 5' amplification).

The computation of the RIN is part of data analysis for total RNA samples. The computed RNA integrity number is shown on the **Results** sub-tab of the **Gel** or **Electropherogram** tab of the **Data** context. It is also included in XML export files and in printed reports.

## 4 Running and Evaluating Electrophoretic Methods/Assays

### Analyzing and Evaluating the Results of an Electrophoretic Method or Assay

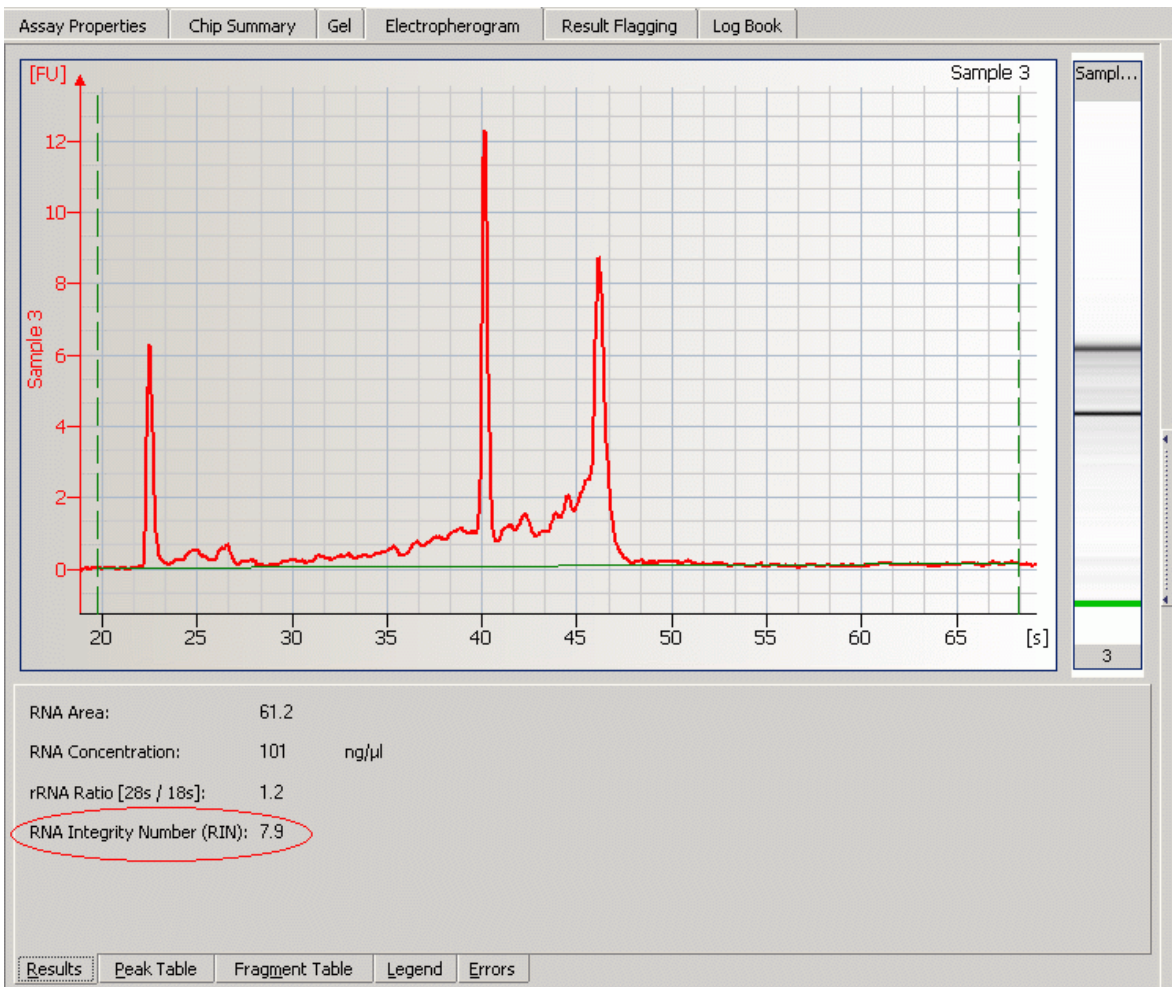

#### NOTE

Until now, the computation of the RIN has only been validated for eukaryote total RNA Nano samples. The 2100 Expert Software also calculates the RIN for prokaryote and plant total RNA samples and for the RNA 6000 Pico method/assay. Be aware that for these samples, the RIN has not been validated in extensive downstream experiments.

Although the lower quantitative limit of the RNA 6000 Nano method/assay is specified as 25 ng/μL it is recommended to use at least 50 ng/μL for a meaningful RNA integrity number. When using lower concentrations, higher sample to sample variances of the RIN may be observed.

## Examples for RNA Integrity Numbers

A database of about 1300 mammalian total RNA samples was created using the RNA 6000 Nano method/assay. The samples came from different species (mainly human, rat and mouse), tissues, preparation methods/assays, concentrations and degradation states. All samples were classified according to their degradation state. Numbers from 1 to 10 were used as labels. 10 stands for a perfect RNA sample without any degradation products, whereas 1 marks a completely degraded sample. The labels in-between are used to indicate progressing degradation states of the RNA sample. The following figure shows typical representatives for each of the 10 RNA integrity classes.

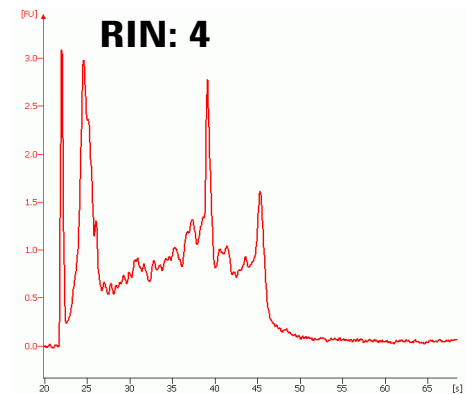
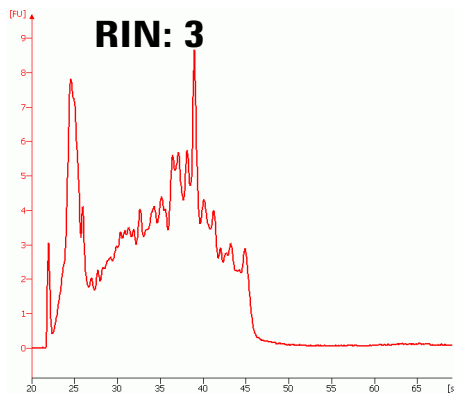
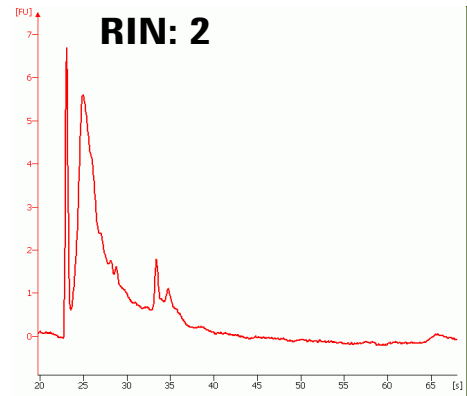
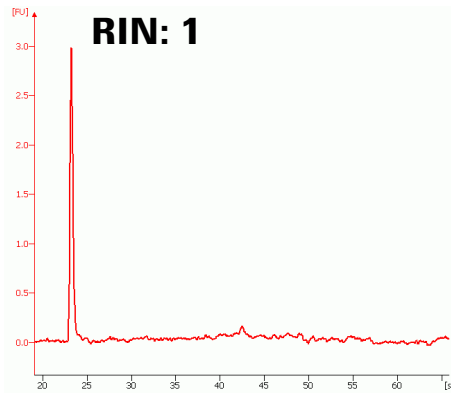

## 4 Running and Evaluating Electrophoretic Methods/Assays

### Analyzing and Evaluating the Results of an Electrophoretic Method or Assay

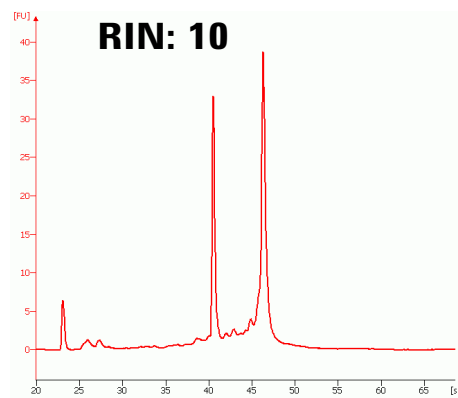
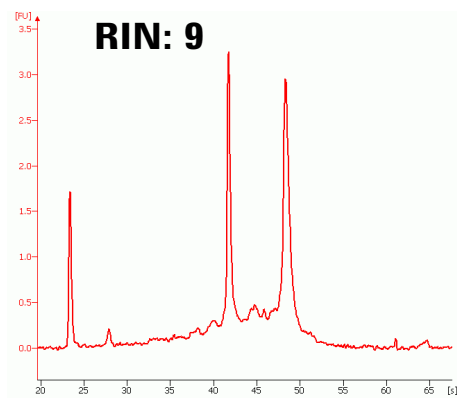
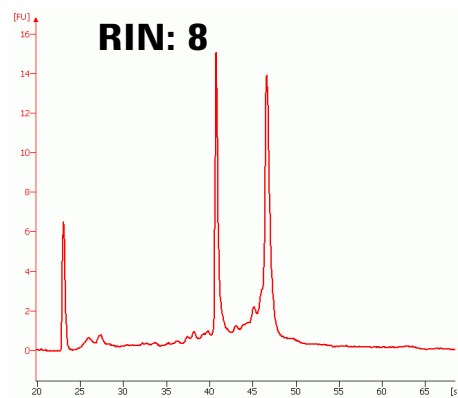
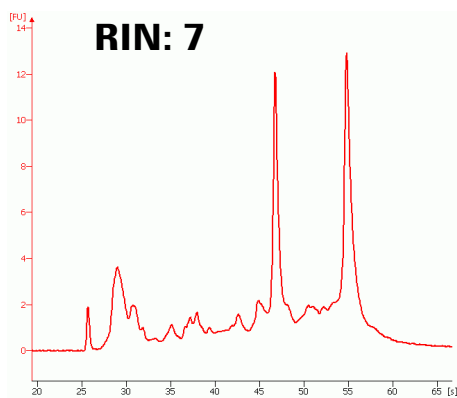
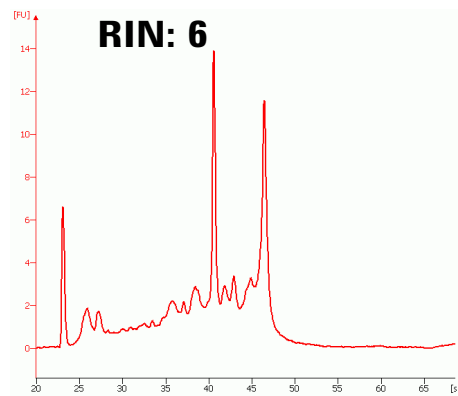
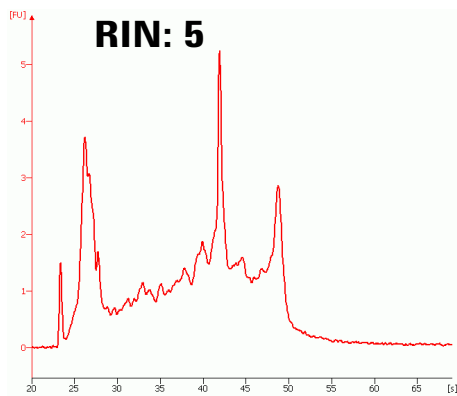

## Computation of the RNA Integrity Number

For the computation of the RNA integrity number, the electropherogram is partitioned into regions as shown in the figure below. The lower marker and the 18S and 28S fragments divide the electropherogram into nine regions:

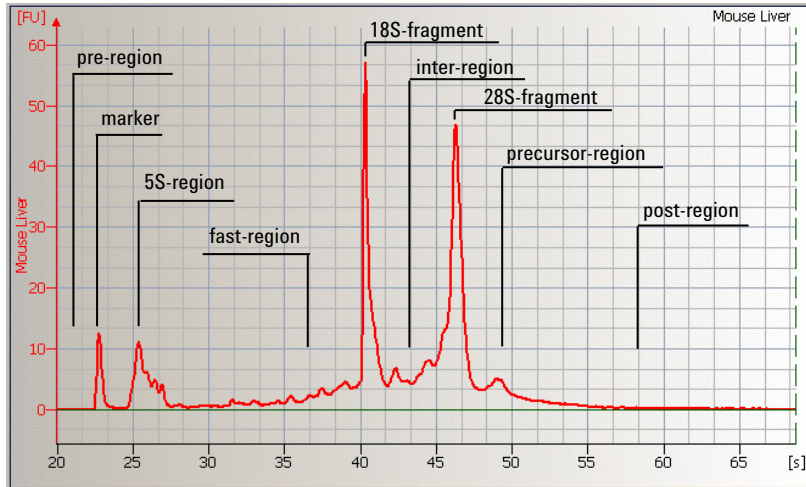

## Signal Anomalies

In addition to the computation of the RIN, the data analysis detects various unexpected signals, disturbing the computation of the RIN. Such disturbances are called anomalies. Region anomaly detectors recognize unexpected signals in each region. If detected, the anomaly is displayed in the **Error** sub-tab of the **Electropherogram** and **Gel** tab.

Anomaly Description	Critical?
Unexpected baseline signal	Yes
Unexpected signal in pre-region	No
Unexpected signal in 5S-region	Yes
Unexpected signal in fast-region	Yes
Unexpected signal in inter-region	Yes
Unexpected signal in precursor-region	No
Unexpected signal in post-region	No
Unexpected ribosomal ratio	Yes
Unexpected sample type	Yes
Unexpected lower marker (compared to previous well)	No

## 4 Running and Evaluating Electrophoretic Methods/Assays

### Analyzing and Evaluating the Results of an Electrophoretic Method or Assay

Two categories of anomalies were introduced, critical and non-critical. Anomalies in regions interfering with the customer sample RNA are considered critical. The corresponding gel lane is flagged red.

The baseline anomaly, for example, is detected for signals with fluctuating or steep baseline. The ribosomal ratio anomaly detects unexpected ratios of the 28S fragment area and the 18S fragment area. The unexpected sample type anomaly is detected for samples which do not fit the standard total RNA profile.

If a non-critical anomaly is detected, the RIN can still be computed accurately. Therefore non-critical anomalies are not flagged. Non-critical region anomalies are pre-region anomaly, precursor-region anomaly and post-region anomaly. The electropherogram below gives an example for a non-critical anomaly in the post-region.

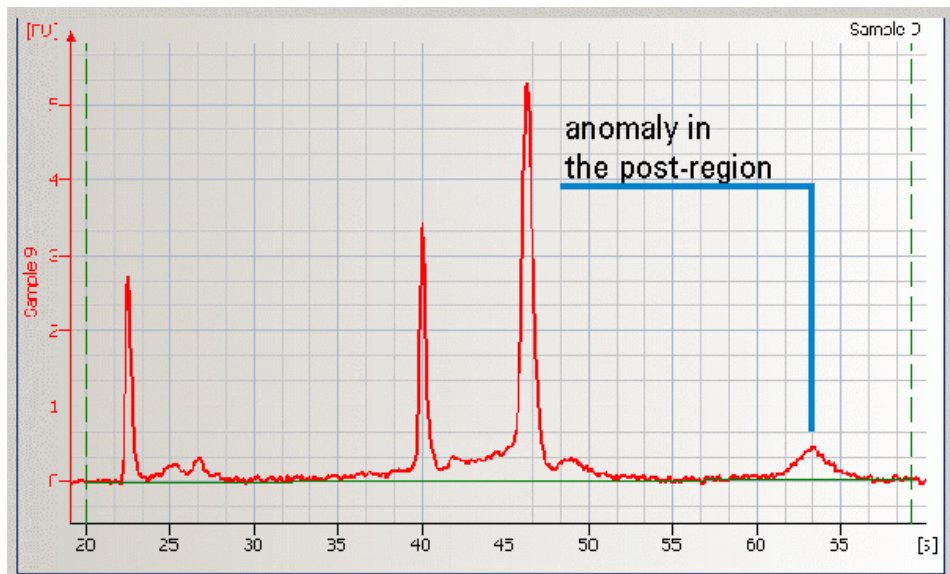



**To take full advantage of the RIN feature, a 2 step use-model is suggested:**

- 1 Determine the threshold value for the RIN that results in meaningful downstream experiments:

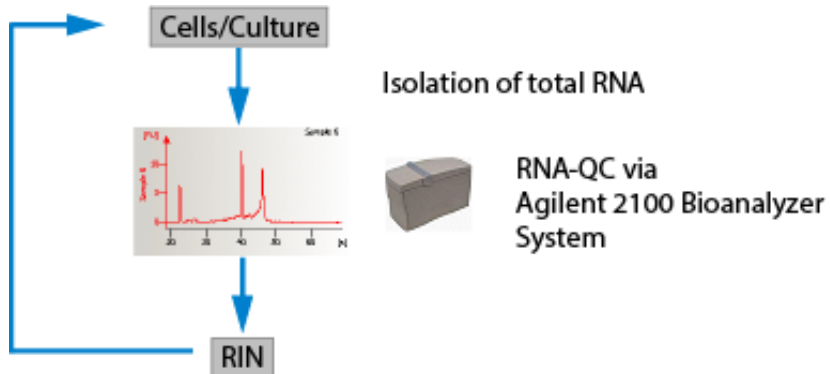

Correlate RIN with downstream experiment and determine threshold RIN for meaningful results (iterative process)

- 2 Run standard experiment and use RIN to determine if sample integrity is sufficient:

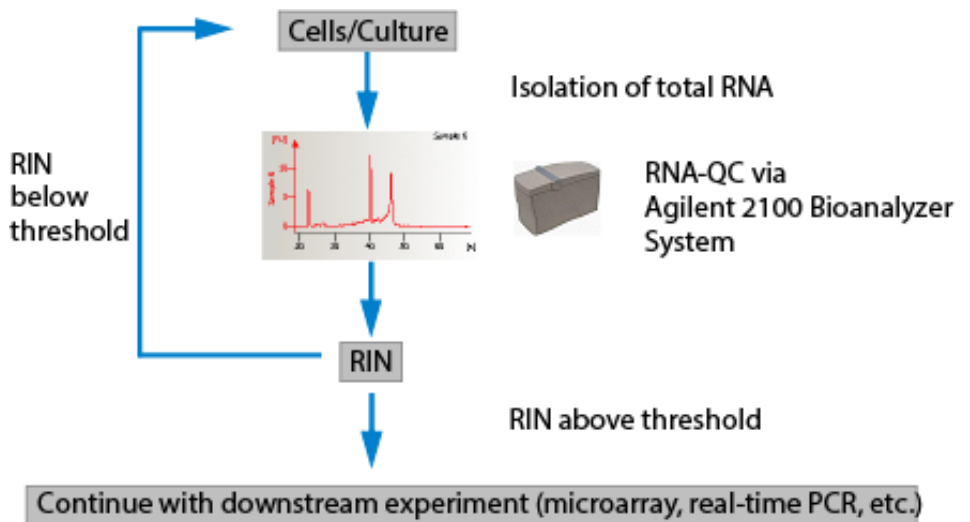

#### Troubleshooting the RIN

To obtain meaningful and reproducible results, the lower marker must be identified correctly. On details on how to adjust the lower marker, please refer to [“Changing the Data Analysis”](#) on page 110.

In rare cases, the RIN value for a sample might not be shown in the **Results** tab but marked as “not available” (N/A). Such results are typically related to unexpected signals and thus critical anomalies, see [“Signal Anomalies”](#) on page 95.

The root cause should be investigated by checking:

- Is the correct assay selected for this experimental run?
- Is the marker correctly assigned by the software?
- Are the ribosomal fragments correctly assigned by the software?
- Are the samples correctly treated and heat-denatured?

Details about the critical signal anomaly are shown in the Errors tab, see [Figure](#) on page 99.

If critical anomalies have been detected during the analysis, in many cases RIN values can still be displayed by increasing the thresholds. The user can modify predefined thresholds for anomaly detection. The higher the threshold the less anomalies are detected. Valid threshold values range from 0 to 1.

How to create your own assay file with adapted anomaly thresholds by default is described in [“How to modify a custom assay method”](#) on page 165. A customized assay will not change the RIN value, which is calculated by an independent algorithm.

#### NOTE

“RIN N/A” is a warning that the RIN may not be reliable for a particular sample (such as due to unusual noise/signals, ribosomal ratio, and other factors). Clearing the critical error message may yield a RIN, but Agilent does not guarantee the accuracy of this value. It is recommended to also perform a visual inspection of the data.

#### RNA Integrity Number Setpoints

Various setpoints are available to customize the display of the RIN (RNA Integrity Number). With these setpoints, you can modify the predefined thresholds for anomaly detection. You can find them in the advanced user mode of the setpoint explorer.

To adjust the setpoints for a single sample, switch to the **Local** tab of the setpoint explorer and open the **RNA Integrity Number** group.

To adjust the setpoints for the whole chip, switch to the **Global** tab of the setpoint explorer and open the **RNA Integrity Number** group in the **Sample Setpoints** group. For the chip, you can additionally switch between integer and decimal representation of the RIN.

For more information on how to use the setpoint explorer, see *About the Setpoint Explorer* (“Changing the Data Analysis” on page 110).

The screenshot displays the software interface for analyzing electrophoretic data. The main window shows an electropherogram with a ladder (L) and 11 samples (1-11). The y-axis represents time in seconds [s], ranging from 20 to 70. The x-axis represents the sample lanes. Below the electropherogram, a table lists the results for each sample. A red box highlights the first row of the table, which contains an error message: 'Unexpected signal in 5s region'. To the right, the 'Setpoint Explorer' panel is open, showing the 'Local' tab. The 'RNA Integrity Number' group is expanded, showing various thresholds for different regions (Pre, 5S, Fast, Inter, Precursor, Post, Baseline, Ribosomal Ratio, Unknown Sample Type) and a Threshold Prerequisite Constant. A red arrow points from the error message in the table to the 'RNA Integrity Number' group in the setpoint explorer.

	Code	Description	Category
1	4,501	Unexpected signal in 5s region.	Analysis

## Data Analysis: Protein

The data analysis process for protein methods/assays consists of the following steps:

- 1 Raw data is read and stored by the system for all samples.
- 2 The data is filtered and the resulting electropherograms are plotted. You can change the settings of the data analysis after the run and reanalyze your data.
- 3 Peaks are identified and tabulated by peak ID. You can change the settings of the peak find algorithm and reanalyze the data after the run has finished. (Note that peak find settings can be changed for all or only certain samples.)
- 4 A sizing ladder (see the example electropherogram below), which is a mixture of proteins of different known sizes, is run first from the ladder well. The sizes of the individual proteins are preset as kDa in the method and cannot be changed. Please note that the individual protein concentrations may vary slightly from ladder lot to ladder lot.

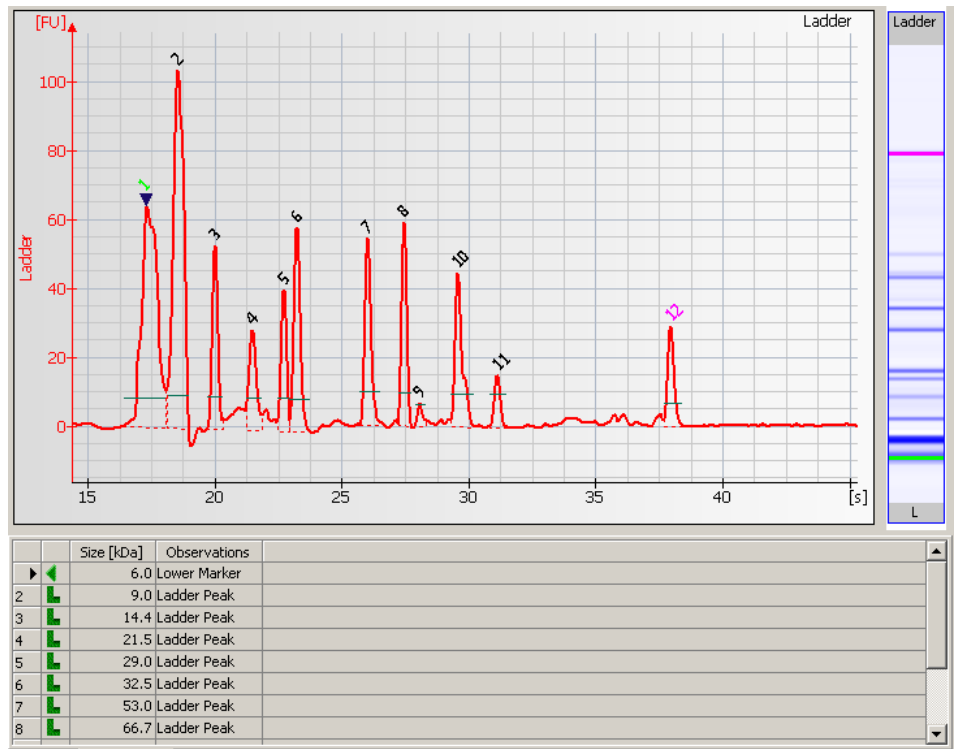

- 5 A standard curve of migration time versus size is plotted from the sizing ladder by interpolation between the individual protein size/migration points. The standard curve derived from the data of the ladder well should resemble the one shown below.

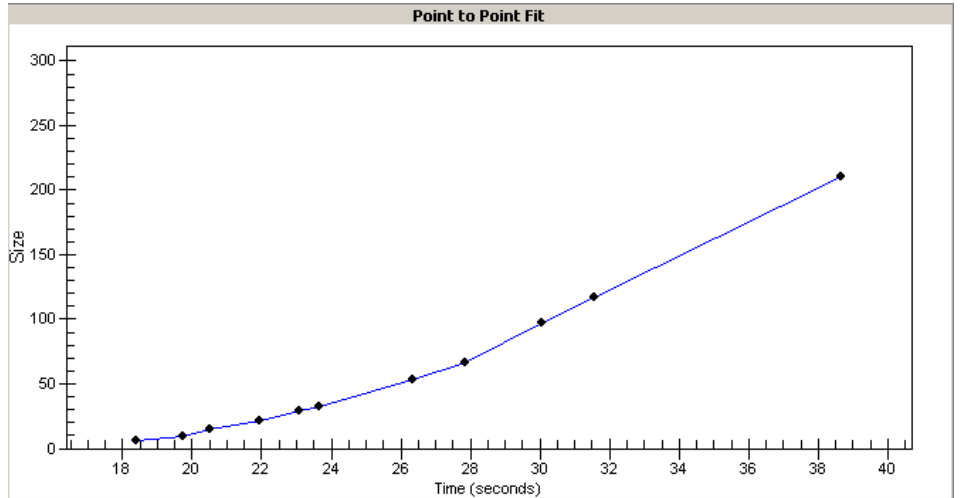

## 4 Running and Evaluating Electrophoretic Methods/Assays

### Analyzing and Evaluating the Results of an Electrophoretic Method or Assay

- 6 Depending on the protein method/assay, one or two internal marker proteins are run with each of the samples. The “lower marker” and/or “upper marker” proteins are used to align the ladder data with data from the samples. The figure below shows an example of assigned marker peaks in a sample well.

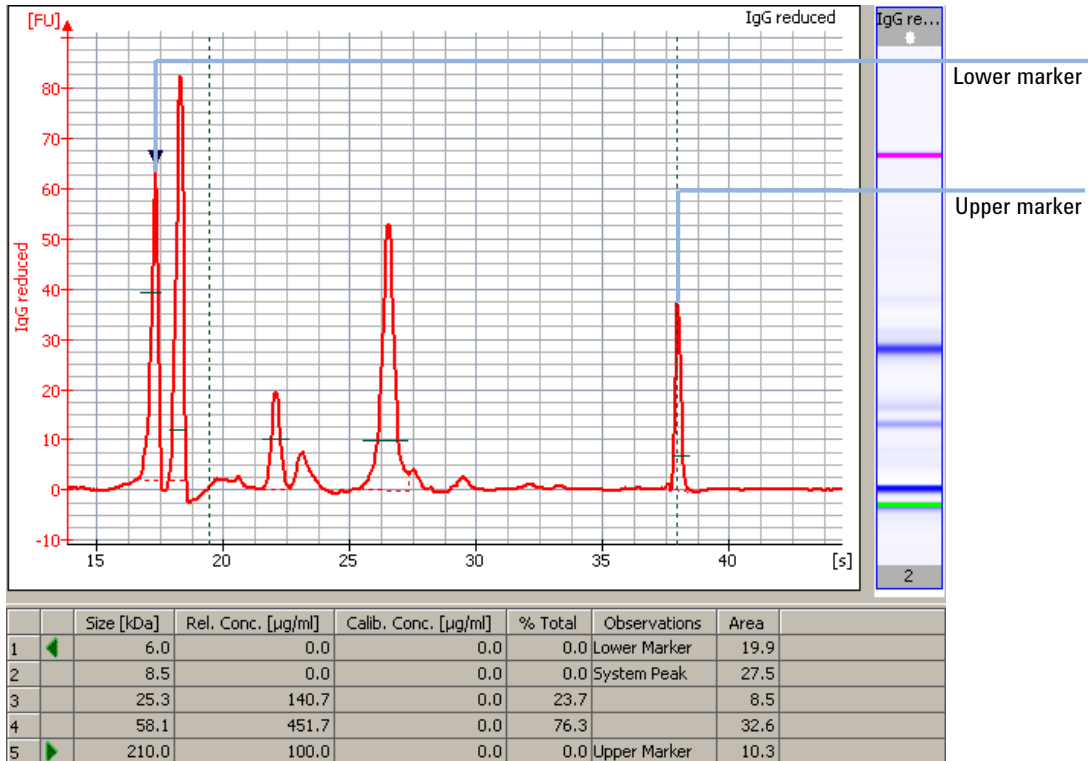

#### NOTE

The software performs alignment by default. Turning automatic data analysis off suspends analysis until you turn it on again.

- 7 The standard curve, in conjunction with the markers, is used to calculate protein sizes for each sample from the migration times measured.

- 8** To calculate the concentration of the individual proteins in all samples of the Protein 80 or the Protein 230 assay, the upper marker with known concentration is used. The concentration is calculated based on the time corrected area underneath each sample peak and the upper marker in the same sample. The protein concentration of the High Sensitivity Protein 250 assay is determined similar to the RNA methods/assays. The relative protein concentration is determined based on the area measured underneath the individual sample peak and the area measured for the ladder on the same chip. For all protein methods/assays it is possible to perform absolute quantification (See “[Absolute Protein Quantitation](#)” on page 103).

**NOTE**

The software allows you to define the markers yourself. A change in the selection of the markers will lead to quantitative changes in the calibration procedure, and therefore in the entire data evaluation.

- 9** In addition to the concentration of the individual proteins, which is listed in the Peak Table, the total relative protein concentration (ng/ $\mu$ L) is determined as displayed in the Results sub-tab.
- 10** The purity (in % total) is calculated for the individual protein of each sample based on the ratio to the total protein concentration.

### Absolute Protein Quantitation

Absolute quantification is calculated based on the relative concentration of a sample and user-defined standards and the known concentration of this standards.

For protein samples you can enable the use of calibration for each sample and enter the concentration of the standard protein. This allows you to generate a calibration curve, which is used to analyze and quantitate this protein within different samples on the same chip. The generated standard curve can also be used to quantitate any other sample protein relative to the standard protein.

## 4 Running and Evaluating Electrophoretic Methods/Assays

### Analyzing and Evaluating the Results of an Electrophoretic Method or Assay

#### Using Calibration in Protein Assays

The calibration feature for protein assays allows quantification based on external standard calibration.

On the **Chip Summary** tab, use the sample table on the **Sample Information** sub-tab to define the samples that you want to use as calibration standards by clicking the checkmark box **Use for Calibration** and enter a concentration.

	Sample Name	Sample Comment	Use For Calibration	Conc. [µg/ml]	Status
1	beta LG		<input type="checkbox"/>	0	✓
2	beta LG		<input checked="" type="checkbox"/>	70	✓
3	beta LG		<input checked="" type="checkbox"/>	140	✓
▶	beta LG		<input checked="" type="checkbox"/>	400	✓
5	ovalbumin NR	non-reduced	<input type="checkbox"/>	0	✓
6	ovalbumin R	reduced	<input type="checkbox"/>	0	✓
7	insulin B chain	20 ug/ml	<input type="checkbox"/>	0	✓
8	standard A		<input type="checkbox"/>	0	✓
9	beta LG	500 ug/ml	<input checked="" type="checkbox"/>	120	✓
10	standard B		<input type="checkbox"/>	0	✓



The calibration standard should be run at least in three different concentrations to generate a calibration curve. The software will automatically produce this calibration curve to determine the actual concentration of the corresponding protein in all other samples within the same chip. In the peak tables of the samples, a remark is added to the observation column to identify the calibration protein and the calibrated proteins:

		Size [kDa]	Rel. Conc. [ $\mu\text{g/ml}$ ]	Calib. Conc. [ $\mu\text{g/ml}$ ]	% Total	Observations
1	◀	3,5	0,0	0,0	0,0	Lower Marker
2		4,2	0,0	0,0	0,0	System Peak
3		4,7	0,0	0,0	0,0	System Peak
4		16,5	31,4	0,0	6,7	
▶	▶	18,5	392,6	131,2	83,7	Calibration Protein
6		28,9	45,1	0,0	9,6	
7	▶	53,0	100,0	0,0	0,0	Upper Marker

		Size [kDa]	Rel. Conc. [ $\mu\text{g/ml}$ ]	Calib. Conc. [ $\mu\text{g/ml}$ ]	% Total	Observations
1	◀	3,5	0,0	0,0	0,0	Lower Marker
2		4,1	0,0	0,0	0,0	System Peak
3		4,5	0,0	0,0	0,0	System Peak
▶	▶	18,4	22,1	7,4	43,2	Calibrated Protein
5		29,1	29,1	0,0	56,8	
6	▶	53,0	100,0	0,0	0,0	Upper Marker

The calibration curve can be displayed by switching to the **Calibration Curve** sub-tab on the **Chip Summary** tab.

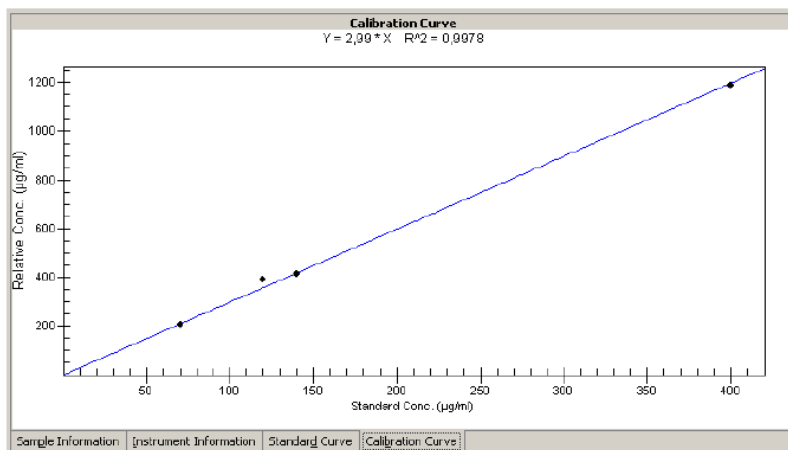

## Smear Analysis

The 2100 Expert Software allows to perform a smear analysis for all electrophoresis methods/assays.

When the smear analysis is enabled (in the advanced setpoints), the software allows you to define regions of interest. These regions are used to define the area of broad peaks and determine their part of the total area. Smear analysis provide a means to analyze broad signals that can be hardly evaluated with the normal peak assignment.

You therefore can define regions that contain the peaks of interest. The regions are defined by size, e.g. base pairs or kDa. For these regions you can determine the region area in relation to the total area.

### NOTE

The 2100 Expert Security Pack restricts access to data and functionality to users who are logged in with certain roles. See *User Role Model* (“[Access Control](#)” on page 39) for details.

## Enabling and Performing Smear Analysis

### To enable smear analysis:

- 1 Go to the **Electropherogram** tab in the **Data** context
- 2 Go to the Setpoint Explorer and select the **Local** or **Global** tab, depending on which samples should be analyzed.
- 3 Select the **Advanced** mode from the dropdown menu.

- 4 Under **Smear Analysis**, select the check box **Perform Smear Analysis**.

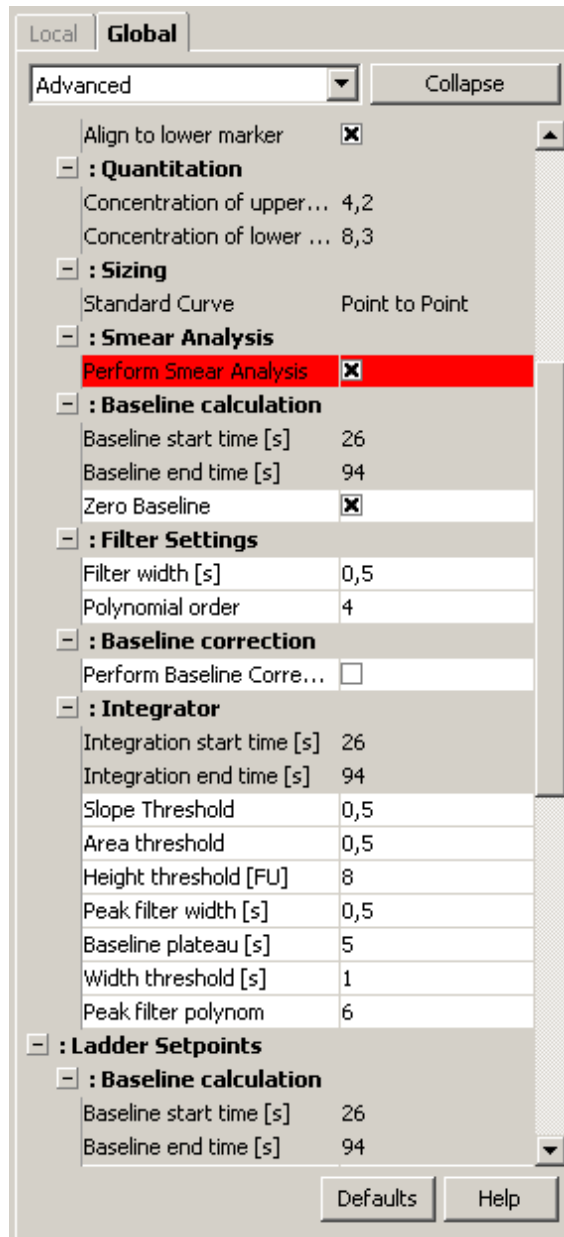

The **Region Table** sub-tab is added to the **Electropherogram** tab.

#### Performing Smear Analysis

After enabling the smear analysis in the setpoint explorer, you are able to insert regions of interest in the electropherogram.

To do so:

- 1 Select the **Region Table** sub-tab in the **Electropherogram** tab.
- 2 Right-click the electropherogram and select **Add region**.  
A region will be inserted into the electropherogram. The **Region Table** shows the values for the inserted region.
- 3 Repeat the previous step until the number of required regions is inserted.
- 4 Adjust the regions by directly moving the dashed lines in the electropherogram.
- 5 To remove a region, right-click the dashed line in the electropherogram and select **Remove Region** from the context menu.

#### NOTE

The smear analysis table can be directly edited by selecting the region table under **Smear Analysis** in the setpoint explorer. It can also be opened when right clicking on the table in the Region Table sub-tab or in the electropherogram. In the region table it is possible to define the regions by entering upper and lower limits.

---

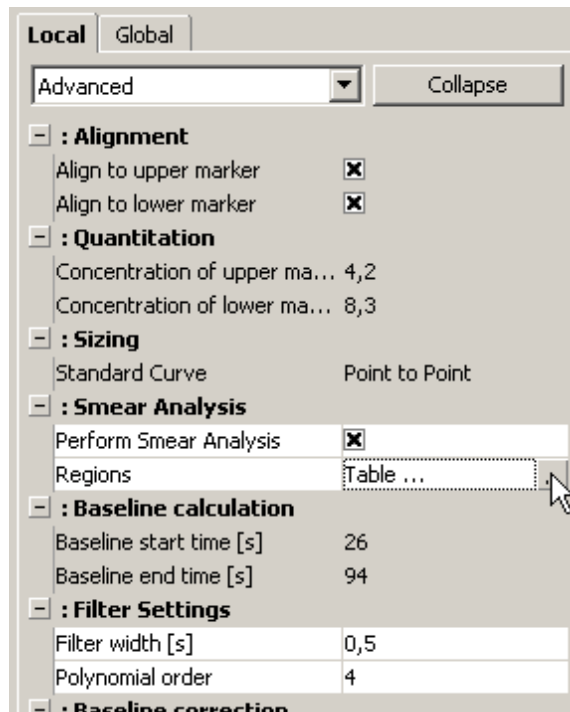

In the smear region table, you can edit the **Region Start Size** and **Region End Size**, for example:

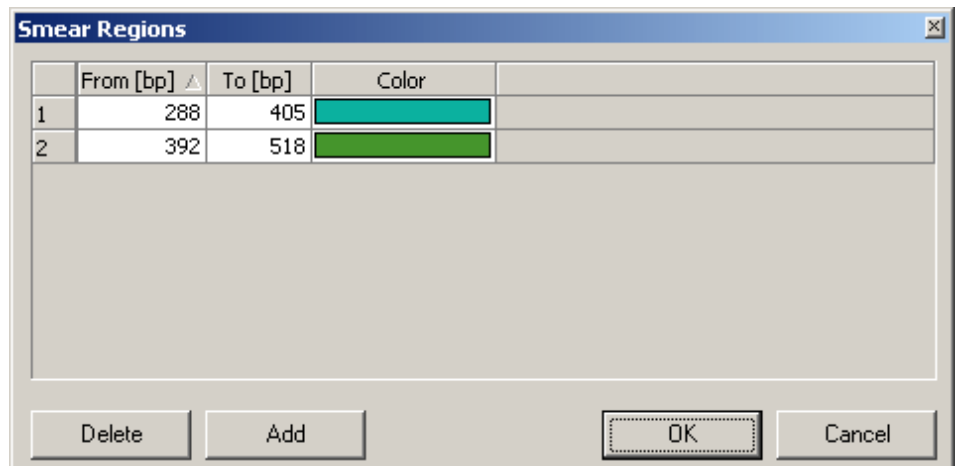

## Changing the Data Analysis

### NOTE

The 2100 Expert Security Pack restricts access to data and functionality to users who are logged in with certain roles. See *User Role Model* ( “[Access Control](#)” on page 39) for details.

Different sets of parameters (data analysis setpoints) can be changed in the software in order to modify the data evaluation for sample analysis:

- Filtering parameters
- Peak find parameters for all samples/peak height for individual samples
- Enabling smear analysis
- Align to upper and/or lower marker
- Adding/deleting ribosomal fragments (for RNA assays/methods only)
- Manual integration (for protein and DNA assays/methods only)
- Absolute quantification (for protein assays/methods only)

These settings can be made before a new run is started or when reanalyzing a previously saved data file.

### About the Setpoint Explorer

The tool allowing you to modify the data analysis setpoints is the Setpoint Explorer. The Setpoint Explorer is accessible from:

- **Assay Properties Tab**
- **Electropherogram Tab (Single/Grid View)**
- **Gel Tab**

On the **Assay Properties** tab, the Setpoint Explorer is always visible and lets you modify setpoints globally (for all samples):

Local **Global**

Advanced Collapse

**Quantitation**

Concentration of upper ... 4,2  
 Concentration of lower ... 8,3

**Sizing**

Standard Curve Point to Point

**Smear Analysis**

Perform Smear Analysis

**Baseline calculation**

Baseline start time [s] 26  
 Baseline end time [s] 94  
 Zero Baseline

**Filter Settings**

Filter width [s] 0,5  
 Polynomial order 4

**Baseline correction**

Perform Baseline Corre...

**Integrator**

Integration start time [s] 26  
 Integration end time [s] 94  
 Slope Threshold 0,5  
 Area threshold 0,5  
 Height threshold [FU] 8  
 Peak filter width [s] 0,5  
 Baseline plateau [s] 5  
 Width threshold [s] 1  
 Peak filter polynom 6

**Ladder Setpoints**

**Baseline calculation**

Baseline start time [s] 26  
 Baseline end time [s] 94  
 Zero Baseline

Defaults Help

## 4 Running and Evaluating Electrophoretic Methods/Assays

### Analyzing and Evaluating the Results of an Electrophoretic Method or Assay

If the Setpoint Explorer is not visible on the Electropherogram/Gel tab, click the vertical bar on the right edge of the application window:



The Setpoint Explorer appears.

For electrophoretic assays/methods, you can modify the setpoints

- *globally*, that is, for all samples (**Global** tab)
- *locally*, for the current sample (**Local** tab)

#### NOTE

On the **Assay Properties** tab the **Local** tab can be enabled by clicking on the individual sample in the **Tree View** panel.

Setpoints can be modified in a **normal** mode (normal user) and **advanced** mode (experienced user). Click the + nodes to expand, and the – nodes to collapse branches. Setpoints that you can change are white. To edit a setpoint, double-click the value, enter the new value, and press enter. The changes are applied automatically.



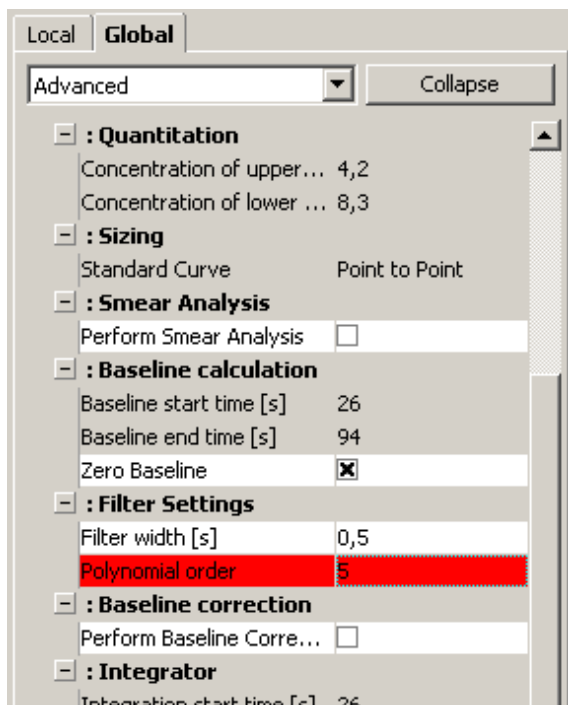

When you try to change any global setpoints where local settings have been applied, the software prompts you as to whether you want to overwrite the local (custom) settings.

If you decide to overwrite the custom sample settings, all local settings you made will be discarded. If you decide not to overwrite the custom sample settings, the global settings will not be applied where local settings have been changed.

Changing setpoints requires that you confirm the action with your electronic signature.

## Color Coding of Setpoint Values

Specific color coding indicates differences between local setpoint values and global setpoint values. The following differences are indicated:

- One local setpoint value differs from the global setpoint value as defined for this assay. On the **Local** tab, a yellow background indicates that a local setpoint value has been modified and differs from the current global setpoint value.

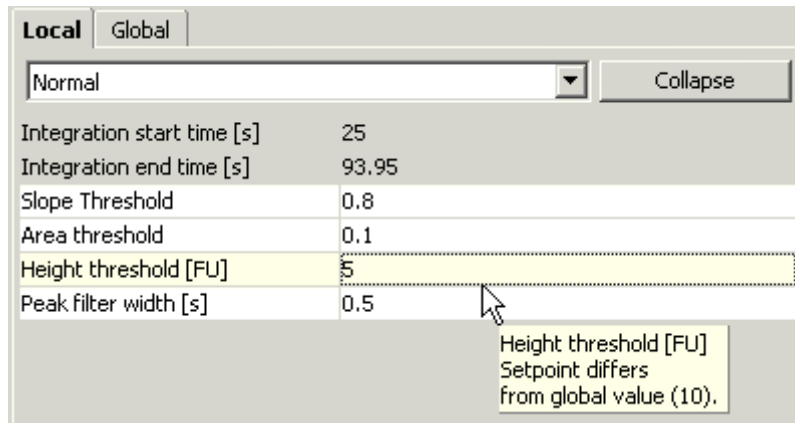

A tooltip displays the global value defined for this assay.

Right-click the local setpoint value to access the following functions:

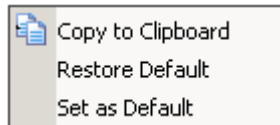

**Copy to Clipboard:** The currently loaded local setpoint values are copied to the clipboard as flat table.

**Restore Default:** The local setpoint value is reset to the setpoint value as currently defined on the **Global** tab.

**Set as Default:** The local setpoint value is set as new global setpoint value, but not automatically applied to all other samples.

On the **Global** tab, the corresponding global setpoint value for which a local setpoint value has been modified is displayed in blue font color.



## 4 Running and Evaluating Electrophoretic Methods/Assays

### Analyzing and Evaluating the Results of an Electrophoretic Method or Assay

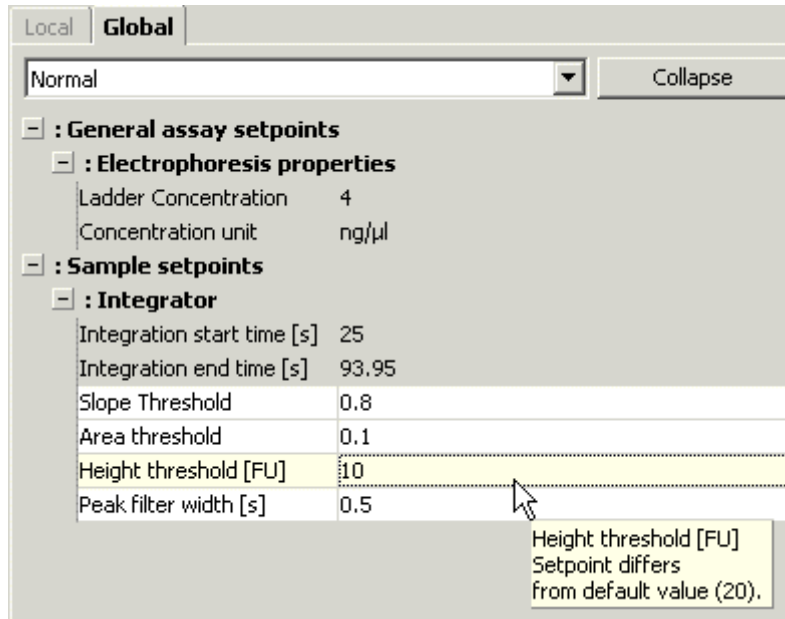

A tooltip displays the global value as preset by Agilent.

- Local setpoint values differ from the global values as preset by Agilent as well as from the global setpoints as currently defined for this assay.

On the Global tab, a blue font color on yellow background indicates that the global setpoint value differs from the global setpoint values as preset by Agilent and at least one local setpoint value.

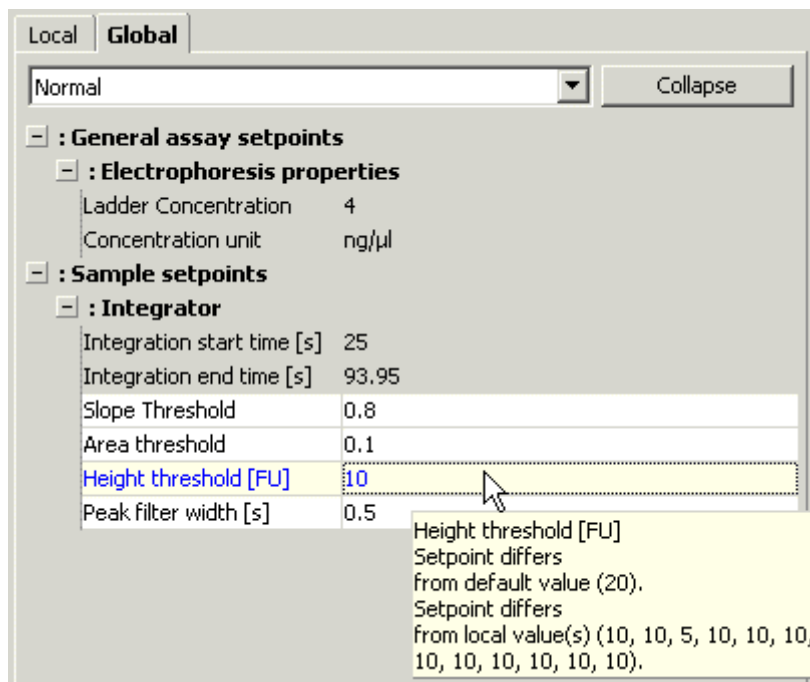

Right-click the global setpoint value to access the following functions:

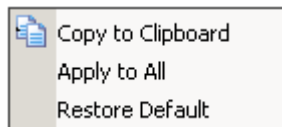

**Copy to Clipboard:** The currently loaded global setpoint values are copied to the clipboard as flat table.

**Apply to All:** The current global setpoint will be applied to all samples and override their current value.

**Restore Default:** The current global setpoint will be reset to default as preset by Agilent, but will not override current local setpoint values.

## 4 Running and Evaluating Electrophoretic Methods/Assays

### Analyzing and Evaluating the Results of an Electrophoretic Method or Assay

#### Filtering Setpoints

The first step the software takes in analyzing the raw data is to apply data filtering. The following filtering setpoints can be changed in the advanced mode under **Filter Settings**:

<b>Filter Width [s]:</b>	Defines the data window, given in seconds, used for averaging. The broader the filterwidth, the more raw data points are used for averaging. As a result, the noiselevel will decrease, but peaks will become lower and broader. Overall, changing the Filter Width has more effect on the result of the filtering procedure applied then does changing the Polynomial Order.
<b>Polynomial Order:</b>	This setting is used to define the power series applied to fit the raw data. The higher the number, the more the fit function will follow the noisy raw data curve. As a result, the noise level of the filtered curve will increase.

## Integrator Setpoints

After data filtering, the peak find algorithm locates the peaks and calculates the local peak baselines. The algorithm begins by finding all the peaks above the noise threshold in order to determine the baseline, after which any peaks below the noise threshold are rejected. A local baseline is calculated for each peak to allow for baseline drift.

Setpoints can be modified in a "normal" mode (normal user) and "advanced" mode (experienced user).

The integrator setpoints that can be changed are:

<b>Slope Threshold:</b>	The Slope Threshold setpoint determines the difference in the slope that must occur in order for a peak to begin. The inverse of this value is used to determine the peak end.
<b>Area Threshold:</b>	The Area Threshold determines the minimum amount of peak area that must be detected before a peak is recognized.
<b>Height Threshold [FU]:</b>	The Height Threshold setpoint determines whether a peak is kept. It represents the minimal peak height. For each peak, the difference between the start point value and the center point value (local baseline) must be greater than the Height Threshold value.
<b>Width Threshold [s]</b>	The Width Threshold determines whether a peak is kept. It represents the minimal peak width. For each peak, the difference between the start and end point (local peak baseline) must be greater than the Width Threshold value.
<b>Peak Filter Width [s]:</b>	The Peak Filter Width setpoint determines the minimum amount of time that must elapse before a peak is recognized.
<b>Baseline Plateau [s]:</b>	The Baseline Plateau setpoint is a parameter that assists in finding peaks. The signal is recognized to be at baseline whenever the slope of the data is less than the Slope Threshold setpoint (either positive or negative) for longer than the time set for the Baseline Plateau. This setting rejects brief, low slope areas such as between non-baseline-resolved peaks.
<b>Peak Filter Polynom</b>	The Peak Filter Polynom setpoint defines the order of the polynom which is used to filter the data to find peaks. The larger this whole number value is the more sensitive is the filter and the more peaks get detected. The peak filter polynom is directly linked to the peak filter width. The entered value multiplied by 0.05 (data rate) must be less or equal the peak filter width.

#### List of setpoints that can be changed

##### General Assay Setpoints

- Electrophoresis Properties
  - Gel Color: Select gel color from dropdown menu
  - Ladder Concentration

##### Ladder and/or Sample Setpoints

- Baseline Calculation
  - Zero Baseline (on/off): Zero signal to baseline
  - Flat Baseline (on/off): If selected, baseline level will be equal to start baseline level.
- Filter Settings
  - Filter Width [s]: Defines the data window used for averaging.
  - Polynomial Order: Defines the power series applied to fit the raw data.
- Baseline Correction
  - Perform Baseline Correction (on/off)
- Integrator
  - Slope Threshold
  - Area Threshold
  - Height Threshold [FU]
  - Width Threshold [s]
  - Baseline Plateau [s]
  - Peak Filter Width [s]
  - Peak Filter Polynom
- Calibration
  - Calibrate All ( on/off)
- Smear Analysis
  - Perform Smear Analysis (on/off)
  - Regions Table
- RNA Fragment
  - Fragment Detection Table: Structure to provide molecular fragment type.
  - Use Dynamic Time Window (on/off): Use dynamic window for detection of ribosoms.



- RNA Integrity Number
  - Pre Region Anomaly Threshold: Sensitivity for detection of signal anomalies before lower marker.
  - 5S Region Anomaly Threshold: Sensitivity for detection of signal anomalies between lower marker and the fast region.
  - Fast Region Anomaly Threshold: Sensitivity for detection of signal anomalies between 5S region and 18S.
  - Inter Region Anomaly Threshold: Sensitivity for detection of signal anomalies between 18S and 28S fragments.
  - Precursor Region Anomaly Threshold: Sensitivity for detection of signal anomalies between 28S fragment and post region.
  - Post Region Anomaly Threshold: Sensitivity for detection of signal anomalies after precursor region.
  - Baseline Anomaly Threshold: Sensitivity for detection baseline signal anomalies.
  - Ribosomal Anomaly Threshold: Sensitivity for detection of unexpected ribosomal RNA ratios.
  - Unknown Sample Type Threshold: Sensitivity for detection of unknown sample types.
  - Marker Anomaly Threshold: Sensitivity for detection of marker anomalies.
  - Single Decimal Represe. (on/off): Show the RIN as integer or with one decimal place.
  - Threshold Prerequisite: Threshold for minimum total RNA concentration to show RIN.

### Manually Moving Fragment Start and End Points (RNA and Cy5-Labeled Nucleic Acids)

It is possible to alter the integration start and end points manually for individual fragments in an RNA or Cy5-labeled nucleic acids assay/method. The integration borders of detected RNA-fragments are displayed in the **Fragment Table** sub-tab. Zooming in on the base of a particular fragment allows you to see the start and end points. Placing the cursor over one of these points changes the cursor to a pointing hand, allowing you to click and drag the point along the line of the fragment until it is positioned as desired.

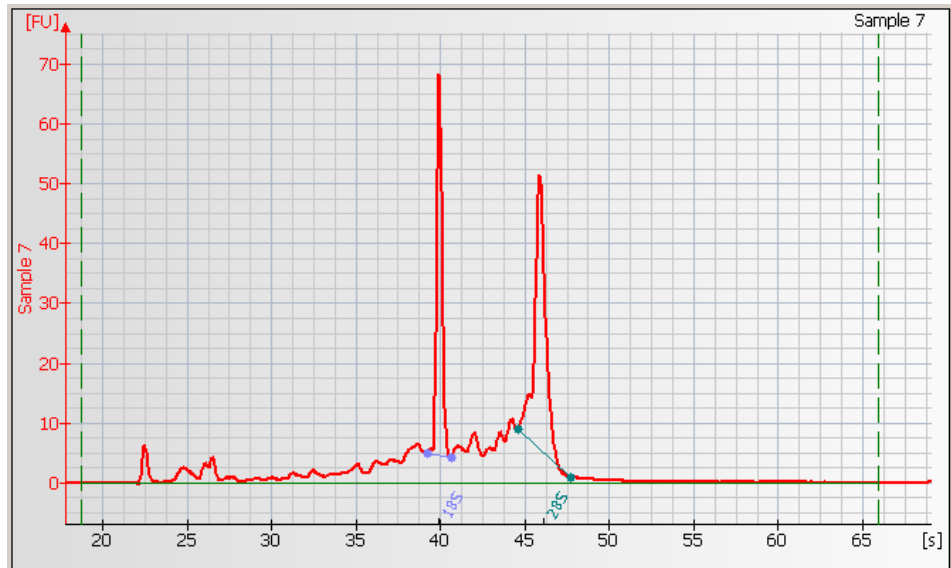

Move any other start or end points as desired. This is only required if the automated integration needs some adjustment.

**HINT**

The fragment table can be directly edited in the setpoint explorer in the advanced mode, **RNA Fragment > Fragment Detection Table**:

	Name	From [s]	To [s]	Color
1	165	38,5	39,72	pink
2	235	43,56	46,19	cyan

**NOTE**

Changing the start or end points of the fragment will change the calculated rRNA ratio and rRNA concentration. The calculated RNA Integrity Number (RIN) is not affected.

It might be convenient to pause the automatic analysis (**Electropherogram > Pause Automatic Analysis**) until all changes are done.

### Setting the Baseline for Calculation of RNA Concentration

At low signal-to-noise ratios, the baseline that defines the area used for calculating the concentration of RNA assays/methods is highly dependent on the settings for the Start and End Time. You can adjust the Start and End Times manually (thereby adjusting the baseline) to ensure a good result even at very low signal-to-noise ratios. Choose a single sample in the Electropherogram Tab, Results Sub-tab. Two vertical green long-dashed lines indicating the setpoints for the Start and End Times (with the baseline drawn between them) are displayed in the window.

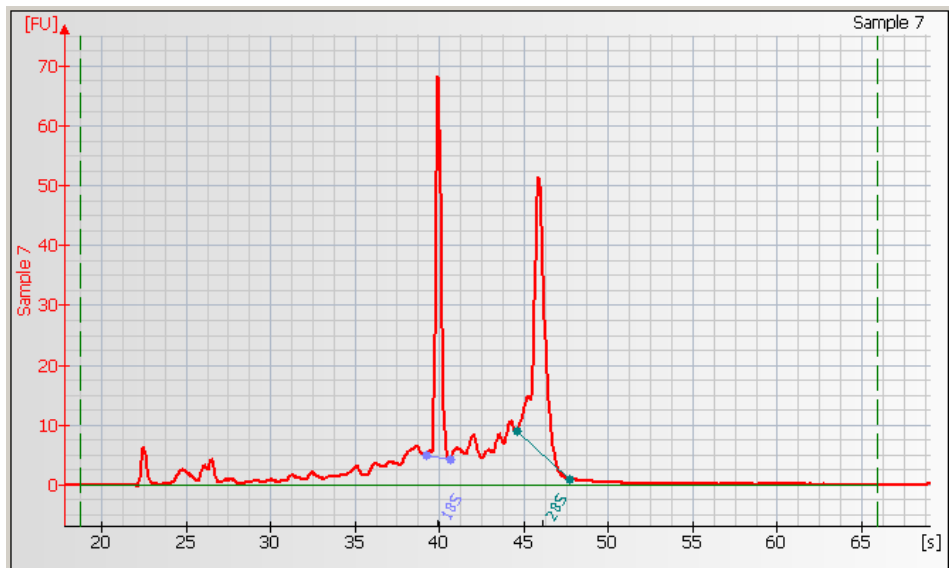

Move the cursor over the long-dashed line on the left (Start Time setting) and drag the line to the desired position. Do the same with the long-dashed line on the right (End Time setting) until you have a flat baseline.

#### NOTE

Changing the start or end points of the fragment will change the calculated rRNA concentration and rRNA ratio. The calculated RNA Integrity Number (RIN) is not affected.

It might be convenient to pause the automatic analysis (**Electropherogram > Pause Automatic Analysis**) until all changes are done.

### Assigning Upper and Lower Marker Peaks (all electrophoretic assays)

For each sample, the upper and/or lower marker peaks are assigned first and then the data is aligned so that the sample markers match the ladder markers in time, allowing the size and concentration of the sample peaks to be determined.

The first peak is assigned to be the lower marker and is then offset to match the lower marker in the ladder. The upper marker, if present, is then assigned to the last peak in the sample or to the peak nearest the ladder's upper marker.

If you get unexpected peaks in the ladder analysis, unexpected sizing results or find that the markers have been set incorrectly, you may exclude peaks manually from the ladder or set a peak to be used as a marker. Right-clicking in the peak table causes a context menu to appear, allowing you to do so:

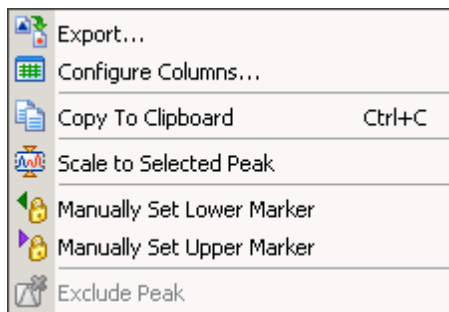

In case the 2100 Expert Software did not detect the markers in the samples correctly, you are able to manually assign them in the same way.

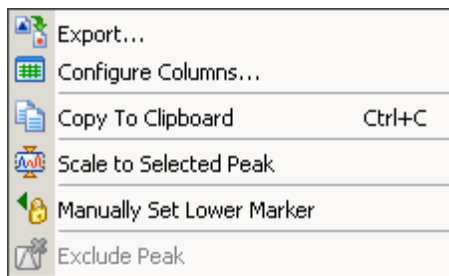

#### NOTE

Excluding a peak or manually setting a peak to be an upper or lower marker may cause errors during analysis.

## 4 Running and Evaluating Electrophoretic Methods/Assays

### Analyzing and Evaluating the Results of an Electrophoretic Method or Assay

#### Aligning or Unaligning the Marker Peaks

The upper and lower are aligned to the ladder markers by resampling the sample data in a linear stretch or compression using a point-to-point fit.

Data before alignment:

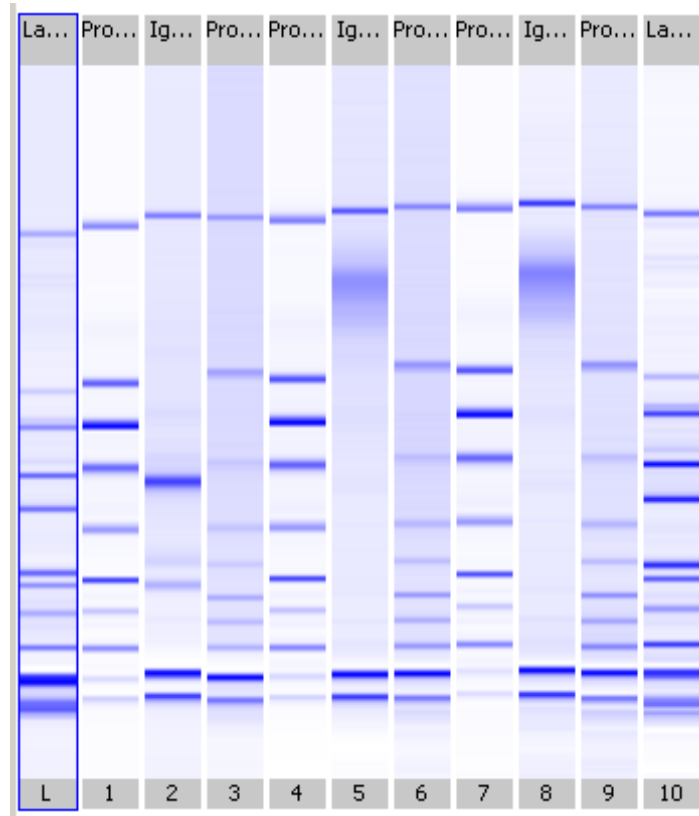

Markers aligned to the ladder:

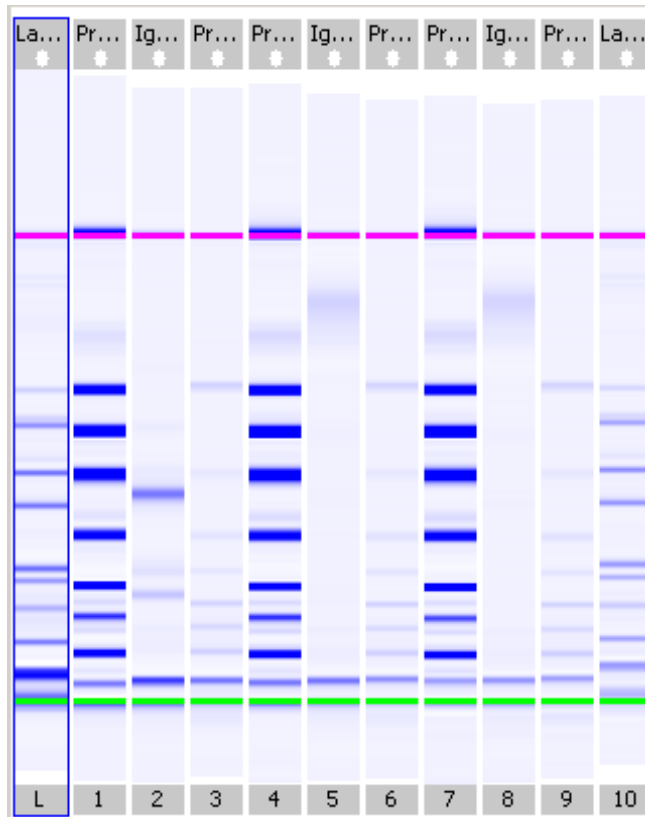

If the sample marker peaks are either more than twice as far apart or less than half as far apart as the ladder markers, they are assumed to be the wrong peaks, and analysis of the sample stops, producing the error “Marker peaks not detected”.

## 4 Running and Evaluating Electrophoretic Methods/Assays

### Analyzing and Evaluating the Results of an Electrophoretic Method or Assay

#### NOTE

With DNA and protein assays/methods, the height of marker peaks is assay/method dependent. Ladder peaks are analyzed to calculate a marker peak threshold that is used to locate the marker peaks in the sample wells. If the marker peaks found using this calculated assay/method fail to align with those of a sample, the 2100 Expert Software will use the minimum peak height threshold setting instead (if this value is lower than the value for the marker peak). For example, the calculated threshold might be too high to find the sample's markers if they happen to be very small for some reason. Either no markers will be found or the wrong peaks will be assumed to be markers and these may not align with the ladder markers. Consequently, the software attempts to use the minimum peak height threshold that, if it is set low enough, will catch the real markers, allowing the sample to align.

---

#### NOTE

After alignment, peaks are shown with relative migration times that are different from the real migration times with data unaligned.

---



## Manual Integration

For DNA and Protein assays/methods, the 2100 Expert Software allows to manually integrate peaks. This is only required if the integration results do not reflect the expectations. Manual integration allows you to move, add or delete peak baselines.

### NOTE

The 2100 Expert Security Pack restricts access to data and functionality to users who are logged in with certain roles. See *User Role Model* (“Access Control” on page 39) for details.

### HINT

To move a peak baseline, point along the vertical line, press the **CTRL** key and left mouse button. To move a peak baseline, point along the signal, press the left mouse button only.

## Examples for Manual Integration

### Example: Adjusting peak baselines

To manually change peak baselines:

- 1 Switch to the **Electropherogram** tab in the Data context and zoom into the electropherogram to enlarge the peak of interest.
- 2 Select **Electropherogram > Manual Integration** to switch on the manual integration.

OR

As an alternative you can click the **Manual Integration** button  in the toolbar.

The baseline points become visible as blue or green dots. Highlighted baseline points are labelled green and can be moved either along the vertical line (press CTRL key and left mouse button) or along the signal trace (left mouse button). The blue baseline points are fixed and cannot be moved. To highlight a baseline point, click it.

## 4 Running and Evaluating Electrophoretic Methods/Assays

### Analyzing and Evaluating the Results of an Electrophoretic Method or Assay

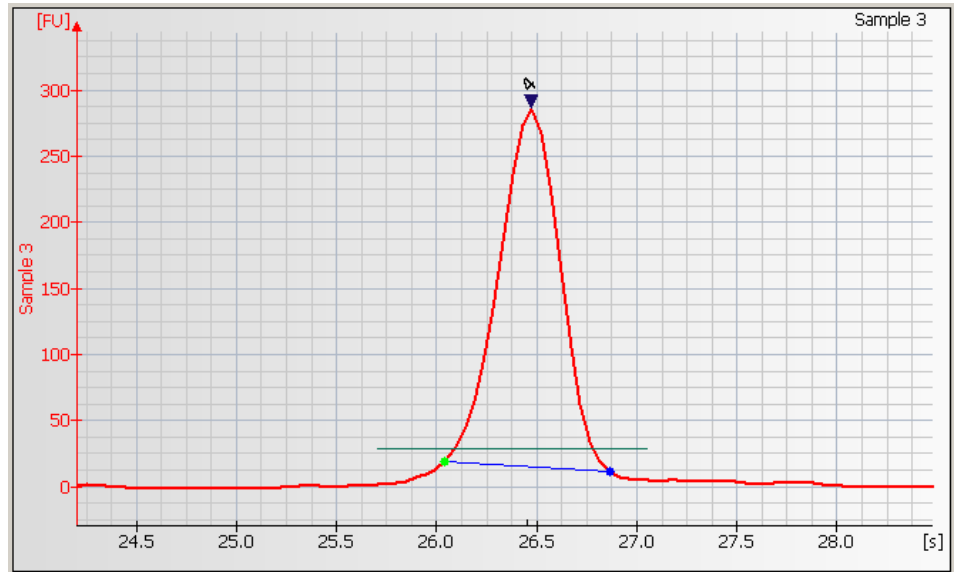

- 3 If you want to change several baseline points, deactivate the automatic analysis by clicking the **Pause Analysis** button in the toolbar.

This way, the software will not recalculate the data analysis with every change.

Once you have changed all baseline points, click the **Pause Analysis** button



again to activate automatic analysis.

- 4 Adjust the baseline points as appropriate.
- To move a peak baseline point along the signal or the vertical dotted line, press the left mouse button.
  - If the new peak baseline point is not on the signal trace, create a new dotted vertical line by press the CTRL key and the left mouse button and move the point along this line.

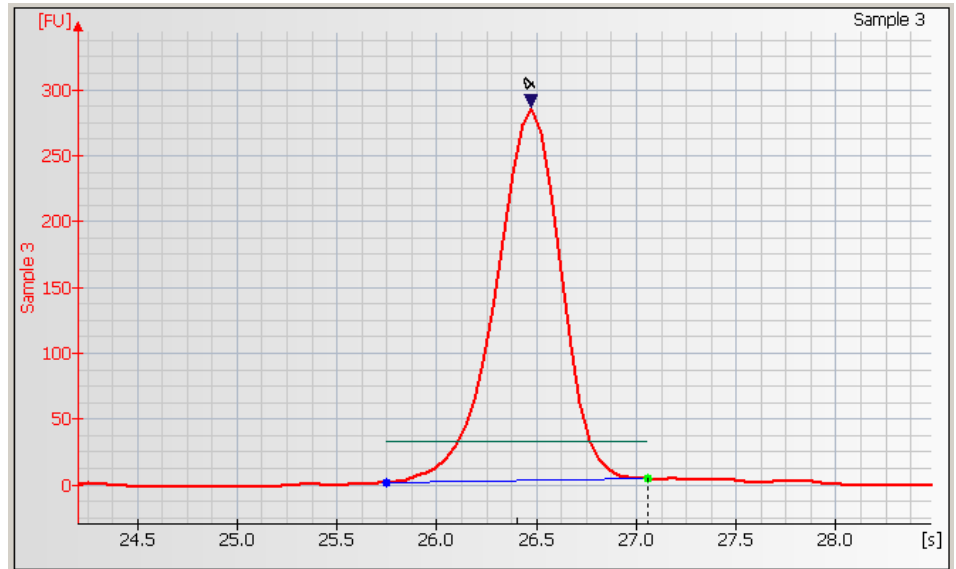

**HINT**

To move a peak baseline point along the vertical line, press the CTRL key and the left mouse button. To move a peak baseline point along the signal, press the left mouse button only.

- 5 Click the **Automatic Analysis** button  to enable the integration again. The integration results in the result and peak tables will change according to the changes done.

## 4 Running and Evaluating Electrophoretic Methods/Assays

### Analyzing and Evaluating the Results of an Electrophoretic Method or Assay

#### Example: Removing peaks

To remove peaks in the *Manual Integration Mode*:

- 1 Switch to the **Electropherogram** tab in the **Data** context and zoom into the electropherogram to enlarge the peak of interest.

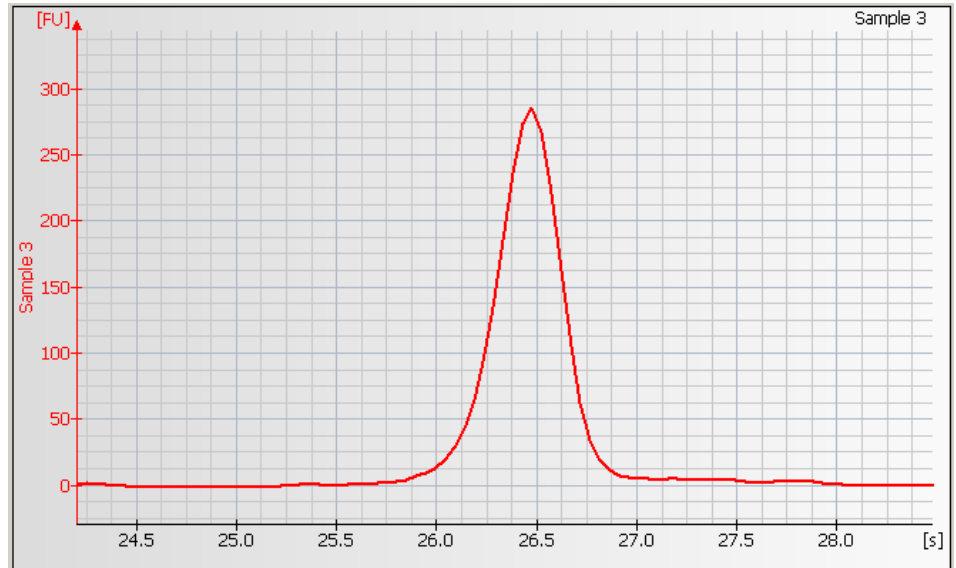

	Size [kDa]	Rel. Conc. [ $\mu\text{g}/\text{ml}$ ]	Calib. Conc. [ $\mu\text{g}/\text{ml}$ ]	% Total	Observations
1	6.0	0.0	0.0	0.0	Lower Marker
2	8.3	0.0	0.0	0.0	System Peak
3	9.5	0.0	0.0	0.0	System Peak
▶	210.0	100.0	0.0	0.0	Upper Marker

- 2 Select Electropherogram > Manual Integration to switch off the automatic integration. As an alternative you might click the Manual Integration button

 in the toolbar.

The baseline points become visible as blue or green dots.

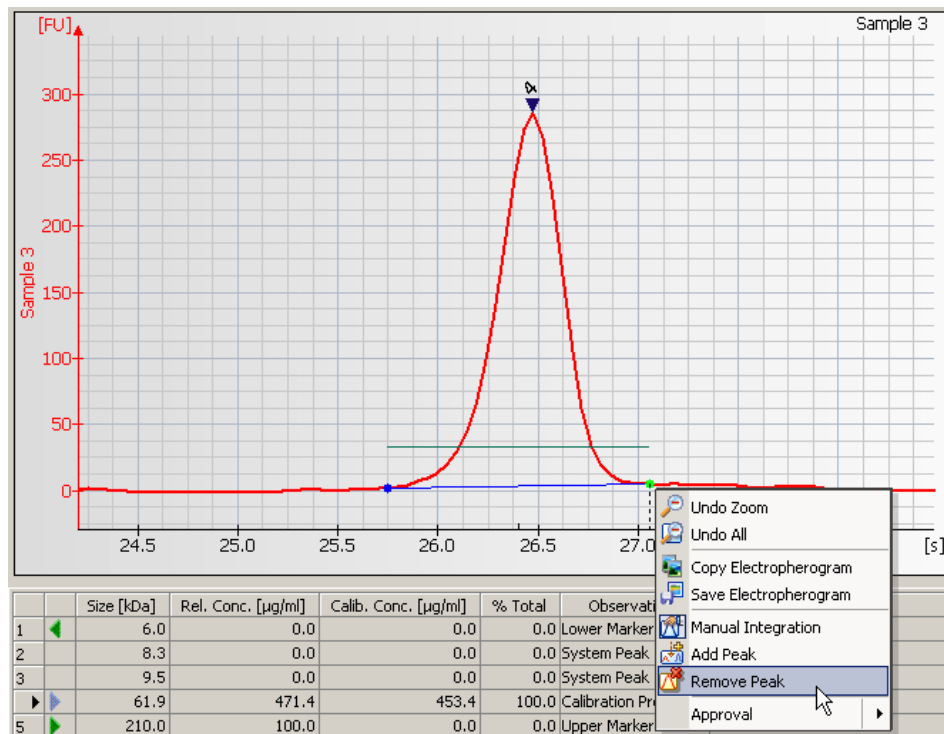

## 4 Running and Evaluating Electrophoretic Methods/Assays

### Analyzing and Evaluating the Results of an Electrophoretic Method or Assay

- 3 Right-click a baseline-point and select **Remove Peak** from the context menu. The two baseline points and the connecting line will disappear and the integration results shown in the result and peak tables will be updated:

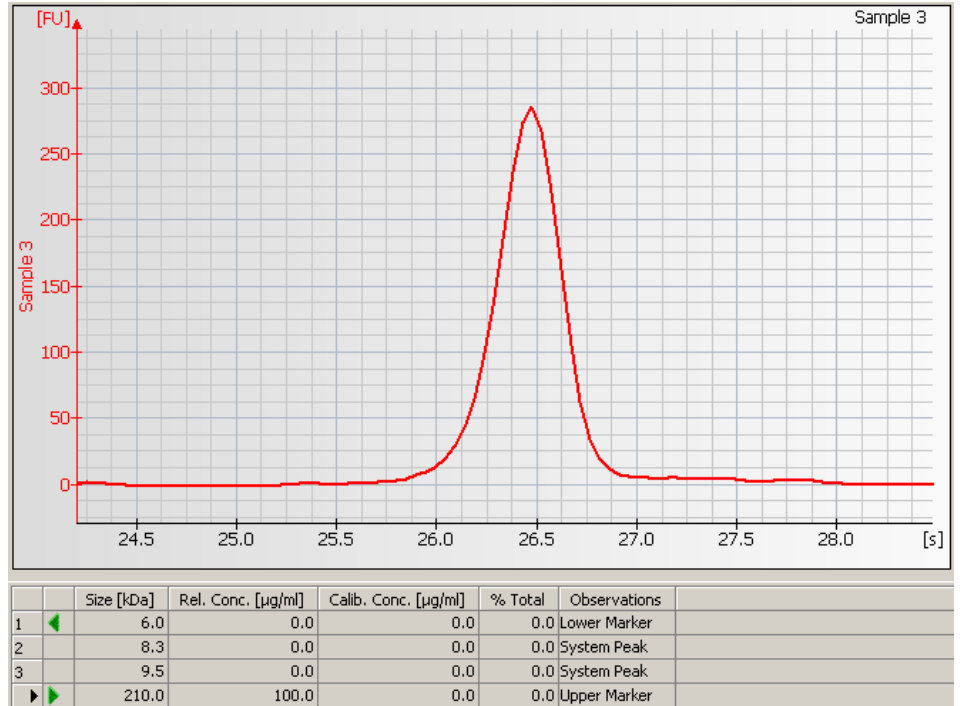

### Example: Inserting peak baselines

To insert peaks in the Manual **Integration Mode**:

- 1 Highlight the **Electropherogram** tab in the **Data** context and zoom into the electropherogram to enlarge the peak of interest.

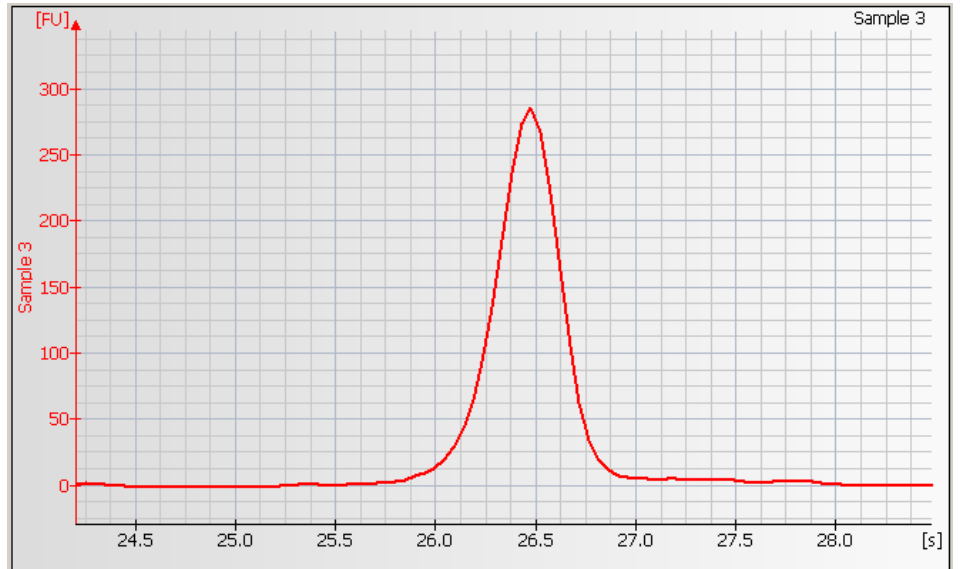

	Size [kDa]	Rel. Conc. [µg/ml]	Calib. Conc. [µg/ml]	% Total	Observations
1	6.0	0.0	0.0	0.0	Lower Marker
2	8.3	0.0	0.0	0.0	System Peak
3	9.5	0.0	0.0	0.0	System Peak
	210.0	100.0	0.0	0.0	Upper Marker

## 4 Running and Evaluating Electrophoretic Methods/Assays

### Analyzing and Evaluating the Results of an Electrophoretic Method or Assay

- 2 Right-click the electropherogram and select **Add Peak** from the context menu.

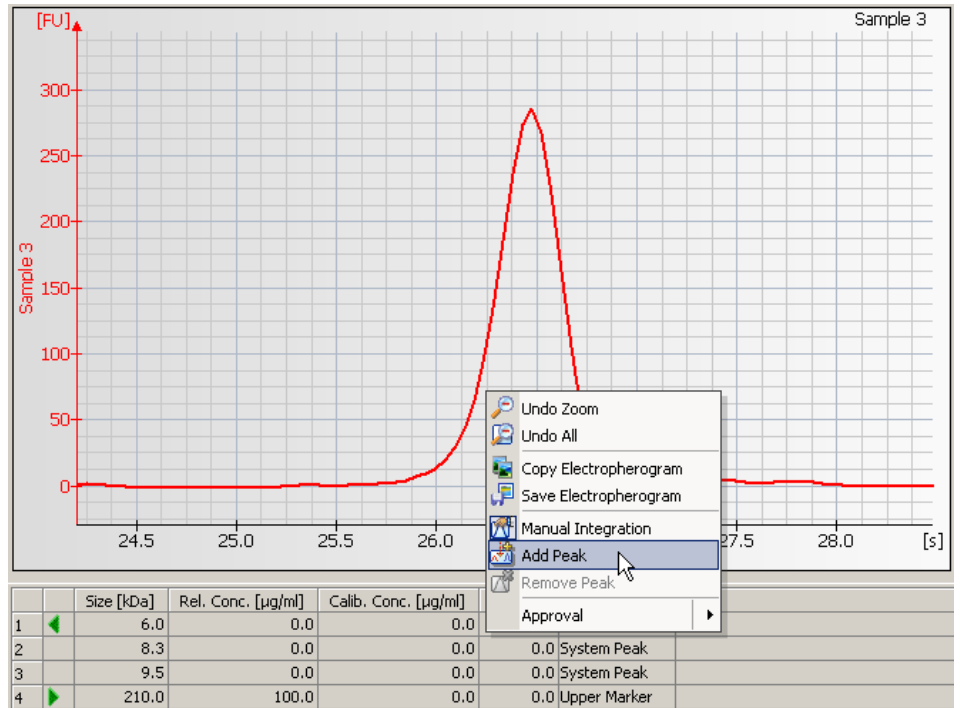



- 3 Two baseline points and the connecting line will appear and the integration results shown in the result and peak tables will be updated.

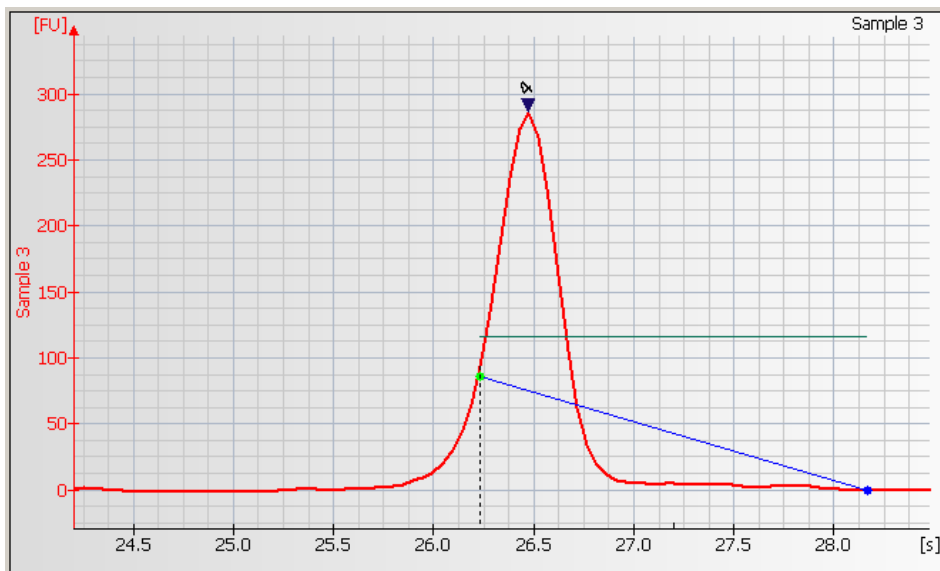

	Size [kDa]	Rel. Conc. [µg/ml]	Calib. Conc. [µg/ml]	% Total	Observations
1	6.0	0.0	0.0	0.0	Lower Marker
2	8.3	0.0	0.0	0.0	System Peak
3	9.5	0.0	0.0	0.0	System Peak
▶▶	61.9	231.3	224.9	100.0	Calibration Protein
▶	210.0	100.0	0.0	0.0	Upper Marker

- 4 Adjust the baseline points as described in “Example: Adjusting peak baselines” on page 129.

## Reanalyzing a Chip Data File

### NOTE

Occasionally you may wish to open and view or reanalyze a chip data file that was run and saved previously. The raw data values are saved in the data file, along with the analysis settings that were chosen for the run, so that the data can be reanalyzed with different settings.

---

### NOTE

The 2100 Expert Security Pack restricts access to data and functionality to users who are logged in with certain roles. See *User Role Model* ( “[Access Control](#)” on page 39) for details.

---

### To do this:

- 1 To open a chip data file (.xad), click **File > Open**.
- 2 Choose the filename from the list of data files.
- 3 Click **OK**.

### The items that can be changed for reanalysis are:

- All assay setpoints see “[Changing the Data Analysis](#)” on page 110,
- sample and study information,
- marker peak assignment,
- manual integration see “[Manual Integration](#)” on page 129,
- result flagging see “[Result Flagging](#)” on page 145,
- quantification.

### HINT

When applying modified data analysis setpoints, performing manual integration or changing the RNA fragment analysis, the software will (by default) immediately recalculate the raw data, which takes some time. Select **Don't Analyze** from the **Gel Menu** or **Electropherogram Menu** to temporarily switch off automatic data analysis while you modify setpoints.

---

If you save the data file after making changes, it will keep a record of the changes such as gel color, sample names, and peak find settings that were in effect at the time the file is resaved. If you do not want to change the original file, choose **File > Save As...** and give the file a new name or save it to a different location.

## Comparing Samples from Different Electrophoretic Chip Runs

The 2100 Expert Software allows you to compare the measurement results of samples from different electrophoretic chip runs. Samples to be compared must be from chip runs of the same method/assay type.

In the **Comparison** context, you can create comparison files, include samples from different chip runs, and compare the samples by overlaying electropherograms, for example.

To compare samples from different electrophoretic chip runs:

### NOTE

The 2100 Expert Security Pack restricts access to data and functionality to users who are logged in with certain roles. See for detail *User Role Model* (“[Access Control](#)” on page 39)

---

- 1 Switch to the **Comparison** context.
- 2 From the **File** menu select **Open**, and open all chip data files (.xad) that contain the samples you want to compare.

The .xad files appear in the **Select Data Files** list of the **Tree View Panel**.

### NOTE

The **Select Data Files** list also contains all electrophoretic .xad files that are currently open in the **Data** context.

---

## 4 Running and Evaluating Electrophoretic Methods/Assays

### Analyzing and Evaluating the Results of an Electrophoretic Method or Assay

- 3 Select a .xad file from the **Select Data Files** list to display a list of its samples.

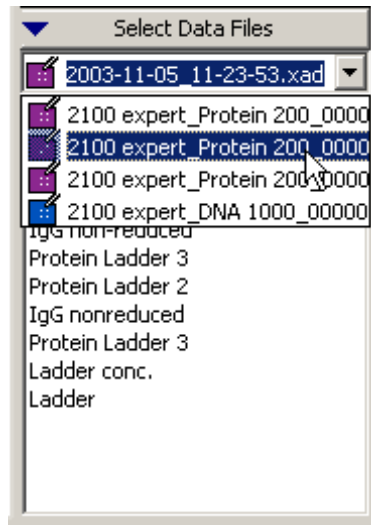

- 4 Right-click a sample name and select **Add Sample to New Comparison File**.

#### HINT

Double-clicking a sample name in the *lower* part of the tree view or dragging a sample name into the tree view adds the sample to the comparison file that is currently selected in the *upper* part of the tree view. Or, if no comparison file is selected, creates a new comparison file and adds the sample to it.

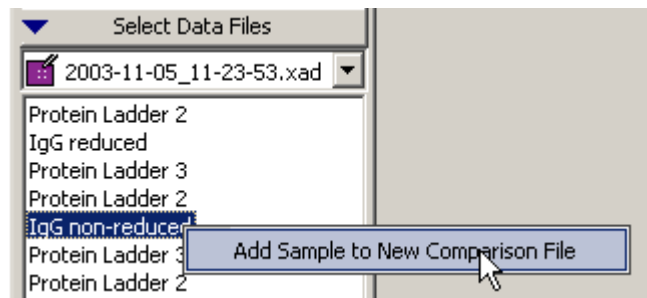

You need to confirm this action with your electronic signature.

A new comparison file appears in the upper part of the tree view containing the sample. The sample is selected and its electropherogram is shown.

## Analyzing and Evaluating the Results of an Electrophoretic Method or Assay

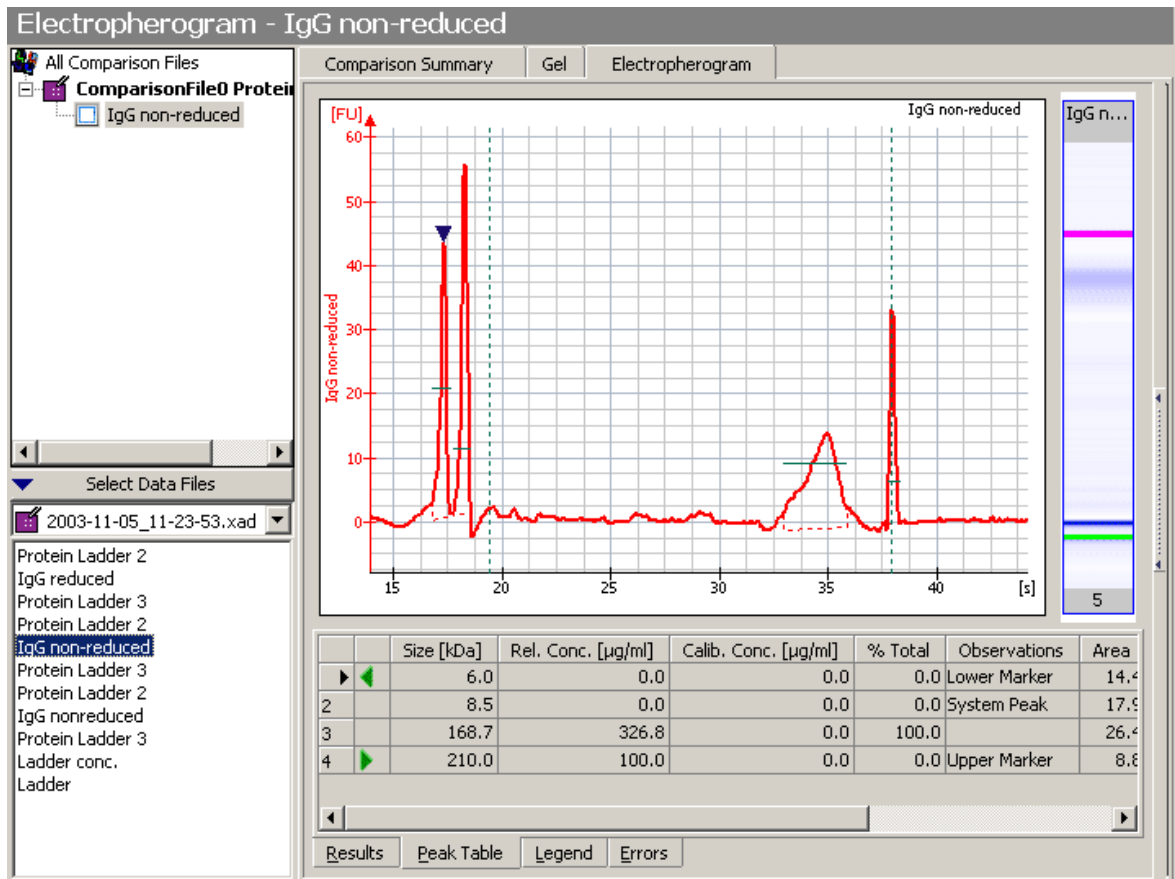

Note that the **Electropherogram** Tab (Single/Grid View) has the same functionality as in the **Data** context.

## 4 Running and Evaluating Electrophoretic Methods/Assays

### Analyzing and Evaluating the Results of an Electrophoretic Method or Assay

- 5 You can now add further samples from any of the open .xad files to the comparison file.

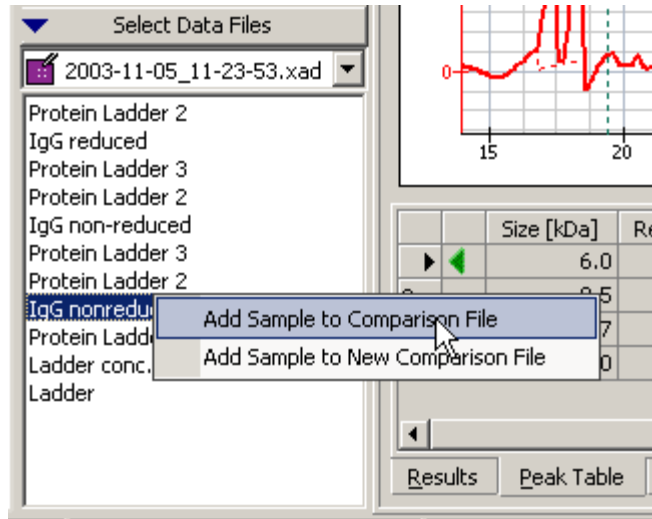

You are notified if you try to add a sample of a .xad file that has the wrong method/assay type.

- 6 To remove samples from a comparison file, right-click the sample name and select **Delete Sample from Comparison File**.

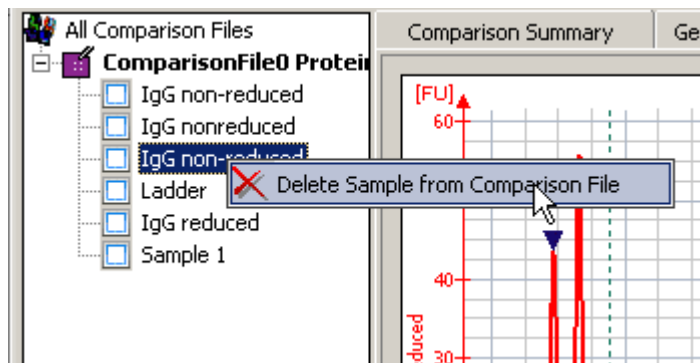

You need to confirm this action with your electronic signature.

- 7 To compare the electropherograms of samples, go to the **Electropherogram** tab, click **Overlaid Samples** in the toolbar and select the samples to be compared.

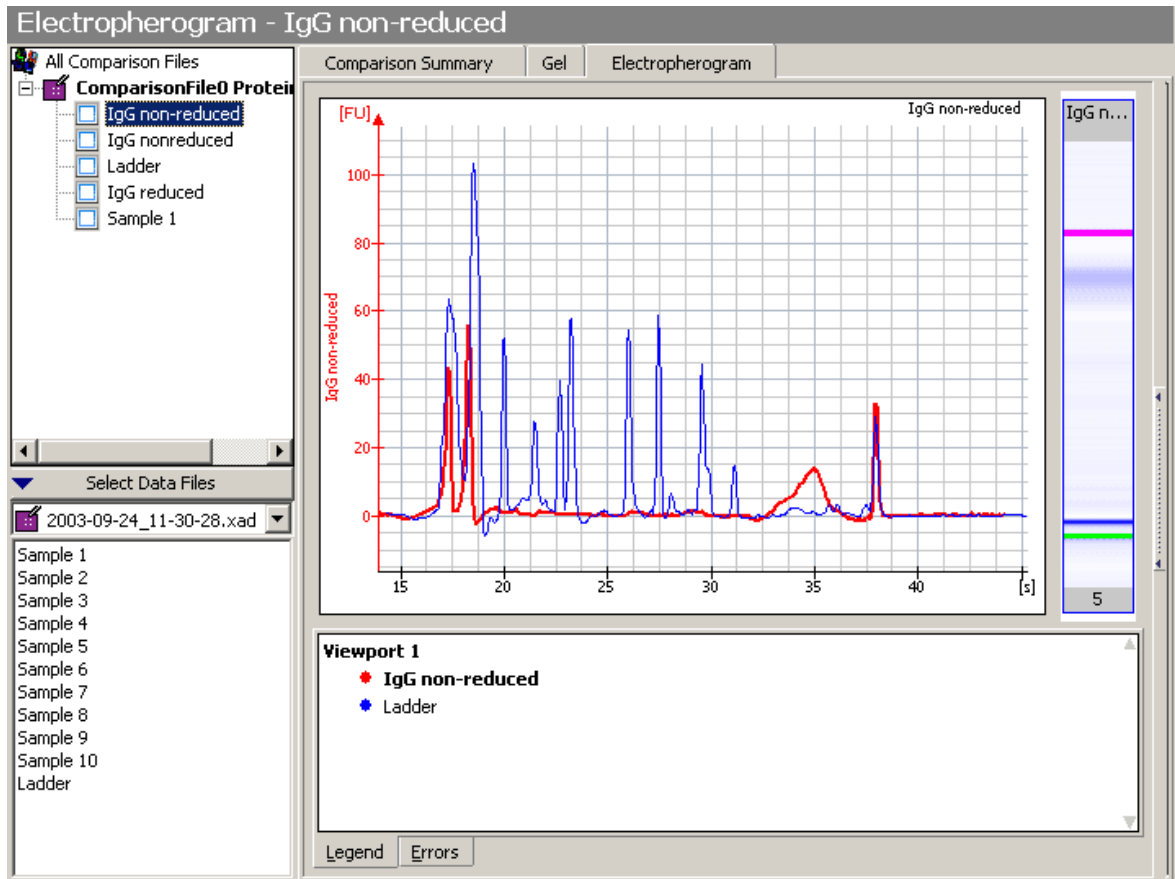

## 4 Running and Evaluating Electrophoretic Methods/Assays

### Analyzing and Evaluating the Results of an Electrophoretic Method or Assay

- 8 Select the **Gel** tab to display a comparison of the gel-like images of the samples.

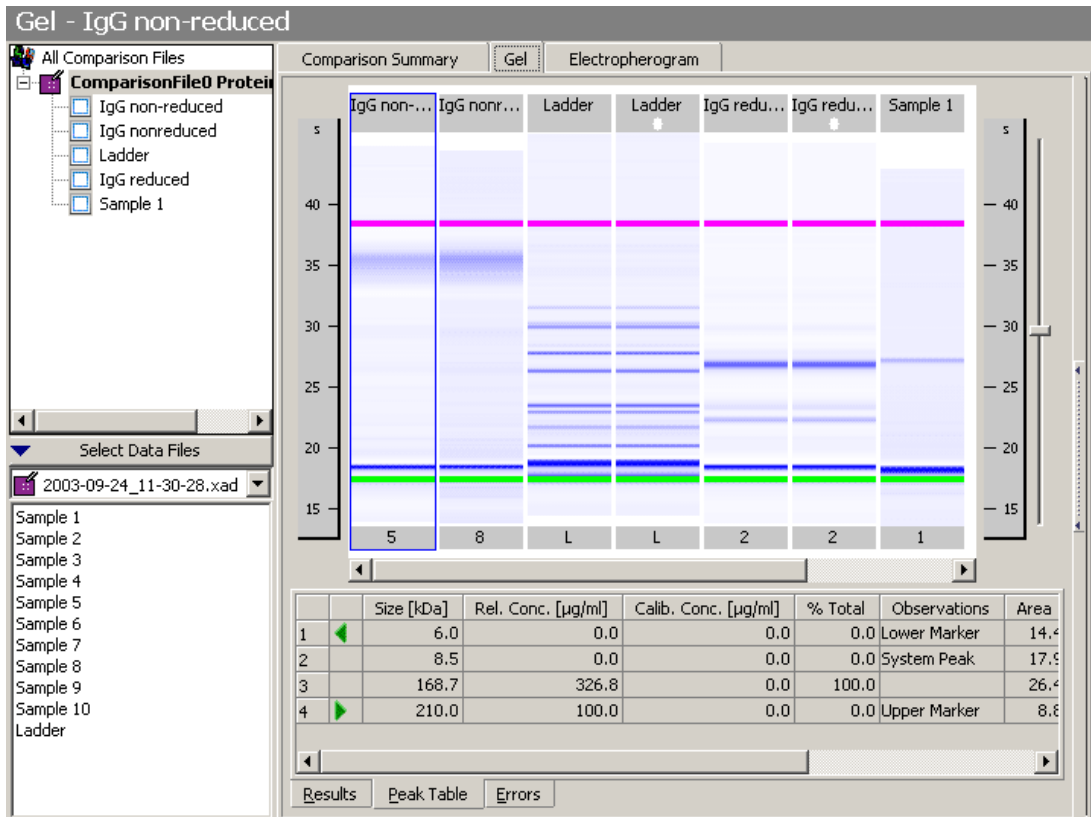

Note that the **Gel** tab has the same functionality as in the **Data** context.

- 9 From the **File** menu, select **Save** to save the comparison file (.xac) under the default name, or select **Save As** to save it under a new name.

The default name is derived from the method/assay class:

“ComparisonFileX [Method Class].xac” where “X” is an autoincremented number. Example: “ComparisonFile0 Protein 230.xac”

You need to confirm this action with your electronic signature.

#### NOTE

You can re-open comparison files to review the comparison results, and to add/remove samples.



## Result Flagging

### NOTE

The 2100 Expert Security Pack restricts access to data and functionality to users who are logged in with certain roles.

See *User Role Model* ( "[Access Control](#)" on page 39) for details.

---

Result flagging can be used to assign a user-defined color code to a sample. This lets you easily identify samples with certain properties immediately after a chip run, e.g. all total RNA samples with RIN above 7.5 are marked in green.

The color assignment is carried out by applying a sequence of rules to the measurement results obtained for the sample. The rules are defined on chip level and are applied to all samples of the chip.

Two modes are available to define result flagging rules:

- Form Mode

In this mode, you can choose an application specific result flagging rule from a given list. Additional attributes, such as size or concentration are entered in the preset forms.

- Editor Mode

This mode is more flexible and allows you to write arbitrary complex expressions by using functions, variables and operators.

### HINT

You can export and import result flagging rules from other method/assay or chip data files. See "[Exporting Result Flagging Rules](#)" on page 179 and "[Importing Result Flagging Rules](#)" on page 172.

---

Regardless of how you create the result flagging rules, there are two options available for the order in which the rules are applied:



- In *Normal* mode, the rules are applied in the given order, and the first matching rule will determine the color of the sample. All rules are applied subsequently. The first rule which applies to the sample defines its color. So you should start with the most specific rule. If that one does not apply, a less specific one may apply. If none of the defined rules apply, the final default rule defines the color code.

## 4 Running and Evaluating Electrophoretic Methods/Assays

### Result Flagging

- In *Target* mode, all rules are applied subsequently. If the next rule applies, the color code changes to the color code defined by the rule, otherwise the previous color code is kept. Therefore, the last matching rule defines the color code of the sample. This mode is called target mode because later rules refine the result color code. The first default color code is the most general and the last one the most specific.

You can switch between the *Normal* or *Target* mode using the **Result Flagging**

menu or the  or  button in the toolbar. You can define the flagging rules already in the method, or—after the chip run is finished—modify these rules or define new rules in the chip data file, and apply the rules to the measurement results. Defined rules can also be saved, loaded and applied to other data files.

#### HINT

The examples shown in this chapter are taken from the demo method/assay “Demo Protein 230 Series II.xsy”, that comes with the 2100 Expert Software. You can find this demo method/assay in the “..\methods\demo\electrophoresis” subdirectory of the 2100 Expert Software installation folder. In the “..\data\samples\resultflagging” subdirectory of the 2100 Expert Software installation folder, you can find further examples for result flagging rules (.xml), which you can import in the “Protein 230 Series II” demo method/assay.

## Defining Result Flagging Rules

The rules can be defined on the **Result Flagging** tab. This tab is available in the Data context if an electrophoretic chip data (.xad.) file is selected and in the Assay context if an electrophoretic assay (.xsy) file is selected.

The screenshot shows the 'Result Flagging' tab in a software application. At the top, there are several tabs: General Properties, Assay Properties, Chip Summary, Gel, Electropherogram, Result Flagging (selected), and Log Book. Below the tabs is a table with the following data:

Rule Index	Rule Comment	Rule Condition	Rule Label	Rule Color
1	Ladder 2 found	PeakFound( 93 , ABS , 1 ) ...	"Found Ladder 2"	Orange
2	Ladder 3 found	PeakFound( 31 , ABS , 1 ) ...	"Found Ladder 3"	Yellow
3	Default rule	TRUE	"All Other Samples"	Blue

Below the table is a configuration panel for the selected rule. It includes fields for Rule Label, Rule Condition, Rule Comment, and Rule Color, each with an 'Edit' button. To the right of these fields are several lists: Functions (PeakFound, PeakConcentration, PeakFoundAuto, NumberOfPeaks, TotalArea), Variables (Well, SampleName, SampleCategory), and Operators (+, -, \*, /, >, <, >=, <=, =, <>, (, ), AND, OR, AND N..., OR NOT).

At the bottom of the window is a help section with the following text:

**Syntax**  
PeakFound(float size, enum Windowtype, float Window, [int ChannelID])

**Description** Used to check whether certain sized fragment is found or not  
It Returns the PeakID of the peak if the fragment was found, otherwise returns 0.  
Size : is the expected fragment size in bp/nt/kDa  
Windowtype: can be PER or ABS  
PER: User will give the window size as percentage of fragment size e.g. +/- 10%  
ABS: User will give the window size as absolute unit of peak size e.g. +/- 10 base pairs (bp)  
window defines the window around the "Size" considered as fragment size  
ChannelID : This is default parameter, if not provided default values is used for this. It determines which channel to use to read peak data.

## How to Use the Form Mode

The **Form** Mode provides some pre-defined rules (forms) that you can use to define the result flagging rules to colorcode your samples. You can set up any number of rules for evaluation. As a typical example of how these forms are used, you can flag DNA samples that have a fragment purity of 10% for fragment sizes of 150 bp.

To do this, proceed as follows:

### NOTE

The 2100 Expert Security Pack restricts access to data and functionality to users who are logged in with certain roles. See “[User Role Model](#)” on page 39 for details.

- 1 Open the chip data file that contains the results to be analyzed in the **Data** context and switch to the **Result Flagging** tab.
- 2 Switch to the **Form** mode going to **Result Flagging > > Form** or by clicking the  icon in the toolbar.
- 3 Choose the **Search Fragment with Purity** form from the **Select Form** list. The **Search Fragment with Purity** form is displayed.

Fragment/protein list

Purity

Tolerance

Logic operation

Labels and color definitions

General Properties | Assay Properties | Chip Summary | Gel | Electropherogram | Result Flagging | Log Book

Search for one or more specific fragments with purity

**1. Specify the fragments to search for**

Index	Fragment Size [bp]
1	150

**2. Specify options**

The sum of the concentrations of the specified fragments compared to the total concentration shall be at least  percent

For the fragment sizes search within a tolerance of  $\pm$   percent

The specified fragment sizes should be treated such that:

All of them must be present

Any of them can be present

**3. Specify results**

The samples that contain the specified fragments

Shall be colored:

Shall be labelled:

All other samples

Shall be colored:

Shall be labelled:

**Help**

This form can be used for searching fragment sizes along with some purity constraints

- 4 Fill out the form following the 3 steps:
  - a Specify the fragments to search for

Define the fragment size(s) to be searched for by clicking on the (+) button to add a fragment and then enter the size in bp for the first fragment. It is possible to add several fragments to the list.
  - b Specify options

Enter the required purity for the fragment size(s) and the tolerance, both in % in the section. If you defined several fragment sizes and want all of these to be present in the flagged samples, select the option **All of them must be present**. If you only require that one of the sizes is present, select the option **Any of them can be present**.
  - c Specify Results

Select the color with which the samples that meet the criteria should be marked. If desired modify the labeling text.

Optionally select the color with which samples that do not meet the criteria should be marked and modify the labeling text.
- 5 Apply this rule to the samples by going to **Result Flagging > > > Apply Result Flagging** or clicking the  icon in the toolbar.

All samples are re-evaluated according to the result flagging rule and displayed with the respective colors.

## 4 Running and Evaluating Electrophoretic Methods/Assays

### Result Flagging

### Color Indication

The results are displayed:

- On the Chip Summary Tab:

General Properties | Assay Properties | **Chip Summary** | Gel | Electropherogram | Result Flagging | Log Book

Data File : 2100 expert\_DNA 7500\_00000\_2005-04-27\_11-34-48.xad  
 Location : C:\...alyzer\2100 expert\SecuredArea\Data\dsDNA\DNA 7500\Demo DNA 7500  
 Created : April 27, 2005 11:34:55  
 Modified : April 27, 2005 12:54:40  
 Software : Created by version B.02.01.SI209, modified by B.02.01.SI209  
 File Version : 8 (Latest version)

	Sample Name	Sample Comment	Rest. Digest	Status	Observation	Result Label	Result Color
1	PCR Mix 1	25, 35, 50, 53, 70, ...	<input checked="" type="checkbox"/>	✓			Blue
2	PCR Mix 2	150, 158, 200, 210...	<input checked="" type="checkbox"/>	✓		Found Ladder 2	Orange
3	PCR Mix 3	500, 550, 600, 650...	<input checked="" type="checkbox"/>	✓		Found Ladder 3	Yellow
4	PCR Mix 1	25, 35, 50, 53, 70, ...	<input checked="" type="checkbox"/>	✓			Blue
5	PCR Mix 2	150, 158, 200, 210...	<input checked="" type="checkbox"/>	✓		Found Ladder 2	Orange
6	PCR Mix 3	500, 550, 600, 650...	<input checked="" type="checkbox"/>	✓		Found Ladder 3	Yellow
7	PCR Mix 1	25, 35, 50, 53, 70, ...	<input checked="" type="checkbox"/>	✓			Blue
8	PCR Mix 2	150, 158, 200, 210...	<input checked="" type="checkbox"/>	✓		Found Ladder 2	Orange
9	PCR Mix 3	500, 550, 600, 650...	<input checked="" type="checkbox"/>	✓		Found Ladder 3	Yellow
10	PCR Mix 1	25, 35, 50, 53, 70, ...	<input checked="" type="checkbox"/>	✓			Blue
▶	PCR Mix 2	150, 158, 200, 210...	<input checked="" type="checkbox"/>	✓		Found Ladder 2	Orange
12	PCR Mix 3	500, 550, 600, 650...	<input checked="" type="checkbox"/>	✓		Found Ladder 3	Yellow

Chip Lot # : 223      Reagent Kit Lot # : 29

Chip Comments : prepared by laura

Sample Information | Instrument Information | Standard Curve

Import...      Export...

The colors in the **Result Flagging** column show which sample matches which rule.

- On the **Gel** Tab and on the small gel image on the *Lower Panel*:

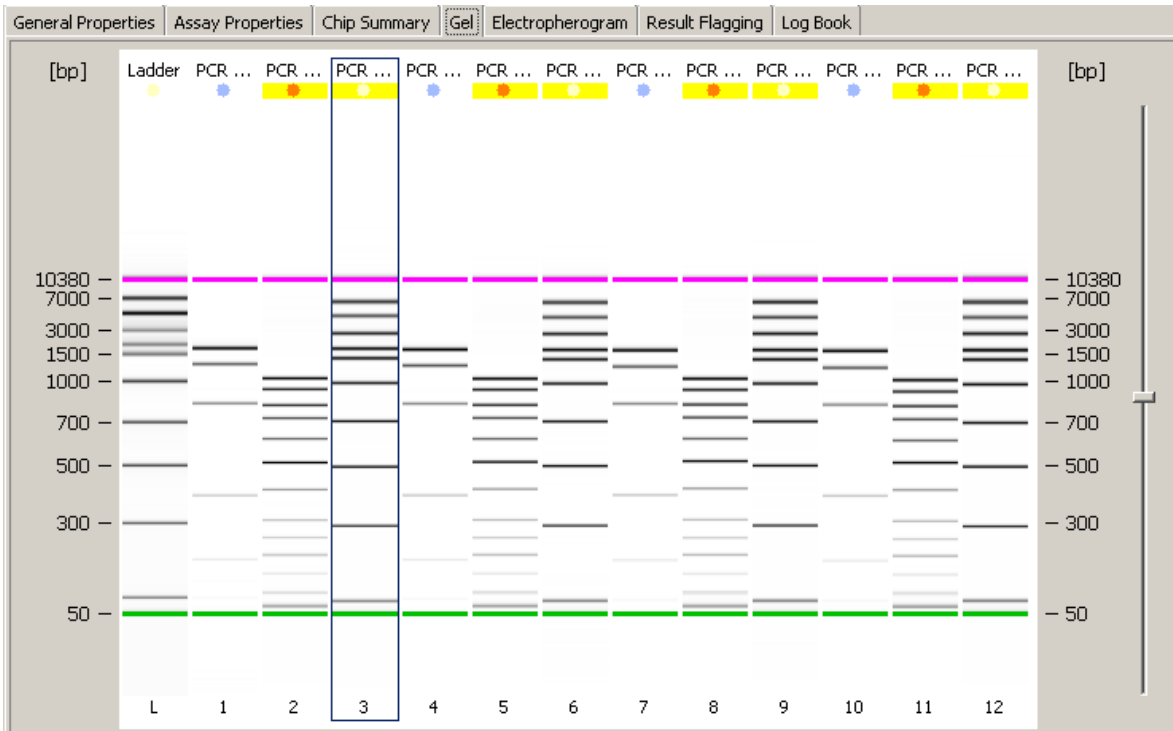

The spot on top of the lane is colored if the sample matches a result flagging rule.

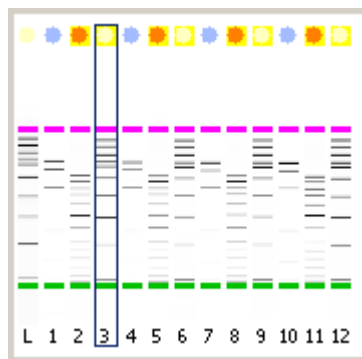

## 4 Running and Evaluating Electrophoretic Methods/Assays

### Result Flagging

- On the **Resultssub-** tab in the **Electropherogram** or **Gel** Tab:

Number of peaks found:	10
Result Flagging Color:	<input type="text" value="Yellow"/>
Result Flagging Label:	Found Ladder 3

Results Peak Table Region Table Legend Errors

**Result Flagging Color:** color of the result flagging rule that the current sample matches.

**Result Flagging Label:** label of the result flagging rule that the current sample matches.





## How to Use the Editor Mode

The editor mode for result flagging is a powerful way for advanced users to create your own result flagging rules.

### NOTE

The 2100 Expert Security Pack restricts access to data and functionality to users who are logged in with certain roles. See *User Role Model* ( "Access Control" on page 39) for details.

#### To define a result flagging rule for a selected chip data file:





- 1 Open the chip data file in the **Data** context and switch to the **Result Flagging** tab.
- 2 Switch to the **Editor** mode going to **Result Flagging > > > Editor** or by clicking the  icon in the toolbar.
- 3 Edit a rule that was created within the **Form** mode. -OR-  
 OR  
 Create a new rule going to **Result Flagging > > > Create New Rule > or > Duplicate Selected Rule** by clicking the  icon or  icon.
- 4 Click the **Edit** button next to the **Label** field and enter or modify the result label for this rule.  
 The result label can be any arbitrary text.
- 5 Click the **Edit** button next to the **Condition** field and enter or modify the logic expression for this rule.

Expressions are built up of functions, variables, operators, and values. You can manually type in the expressions. But you can also double-click the items in the **Functions**, **Variables**, and *Operators* lists, to insert them in the respective fields. As an example for a logic expression for the rule condition, enter

`NumberOfPeaks > 9 AND PeakFoundAuto(150)`. With this rule, all samples can be found that have more than nine peaks while one of them has a size of 150 bp  $\pm$  10%. Detailed descriptions of the available functions as well as the required syntax and examples are shown in the Help field at the bottom of the screen.

**NOTE**

If the entered syntax is not correct, the invalid part is displayed in red color.

- 6 Click the **Edit** button next to the **Comment** field and enter or modify a comment for this rule.
- 7 Click the **Edit** button next to the **Color** field and select a color. If you check the Gradient check box, you can assign a color gradient to the rule. It is useful for example to use this gradient function for purity or concentration.
- 8 If necessary, generate additional rules.
  - a To rearrange the order of the rules go to **Result Flagging > > Move Selected Rule >** or **> Move Selected Rule Down** or click the  and  icons in the toolbar.
  - b To reset the form go to **Result Flagging > > Reset Form** or click on the  icon in the toolbar.
- 9 To apply the rules to your measurement results, go to **Result Flagging > > > Apply Result Flagging** or click the  icon.

If there still are syntax errors in the rule definitions, an error message appears. All samples are re-evaluated according to the result flagging rules and displayed with the respective colors. See “[Color Indication](#)” on page 150 for more information on the color codes.

**NOTE**

Additional information is available in the **Help** panel at the bottom of the screen. This panel provides context-specific help, including examples.

You can reuse result flagging rule definitions, see “[Exporting Result Flagging Rules](#)” on page 179 and “[Importing Result Flagging Rules](#)” on page 172.

## Example: Result Flagging

Sample 1 contains 100 µg/mL proteins. The electropherogram shows 2 peaks for 2 different proteins, which could be separated. One peak can be found at 32 kDa (LDH).

Sample 2 contains 60 µg/mL proteins and shows 3 peaks.

Sample 3 contains 80 µg/mL proteins and shows 5 peaks.

Now, the following rules are defined:

### NOTE

The 2100 Expert Security Pack restricts access to data and functionality to users who are logged in with certain roles. See *User Role Model* (“Access Control” on page 39) for details.

1 Is there a peak at 30 kDa +/- 7%?

Rule 1:

**PeakFound(30, PER, 7)**

2 Is the total concentration of proteins higher than 90 µg/ml?

Rule 2:

**TotalConcentration > 90**

3 Were 5 to 10 peaks found?

Rule 3:

**NumberOfPeaks >= 5 AND NumberOfPeaks <= 10**

Alternative Rule 3:

**NumberOfPeaks BETWEEN (5,10)**

Rule Index	Rule Comment	Rule Condition	Rule Label	Rule Color
1		PeakFound(30, PER, 7)	"Any peak at 30 kDa +/- 7 %"	
2		TotalConcentration() > 90	"Total concentration > 90"	
3		NumberOfPeaks() >= 5 AND NumberOfPeaks() <= 10	"Number of peaks between 5 and 10"	
4	Default rule	TRUE	""	

Applying these rules in the given order (in *Normal* mode) leads to the following results:

	Sample Name	Sample Comment	Use For Calibration	Conc. [µg/ml]	Status	Observation	Result Label	Result Color
1	beta LG		<input type="checkbox"/>	0	✓		Any peak at 30 kDa +/- 7 %	
2	beta LG		<input type="checkbox"/>	0	✓			
3	beta LG		<input type="checkbox"/>	0	✓		Number of peaks between 5 and 10	

## 4 Running and Evaluating Electrophoretic Methods/Assays

### Result Flagging

For sample 1, rule 1 matches and defines the color. Rule 2 would also match, but is not checked, because the procedure stops at the first match.

For sample 2, none of the rules match, if there is no peak at 30 kDa +/- 7%. Therefore, this sample will get the default color.

For sample 3, only rule 3 matches and defines the color.

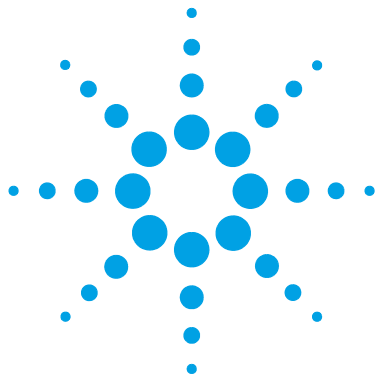

## 5 Working with Chip Data and Methods/Assays

Working with Chip Data and Methods/Assays	158
2100 Export Data Overview	159
Handling Methods	162
Handling Methods	162
Handling Chip Data	166
Organizing, Backing up, and Archiving 2100 Expert Data	167
Importing Data	169
Importing 2100 Bioanalyzer System Files	169
Importing Data Analysis Setpoint	170
Importing Chip and Sample Information	171
Importing Result Flagging Rules	172
Exporting Data	173
Exporting Chip and Sample Information	174
Export Chip Run Data	174
Printing Reports	180
How to Print a Chip Run Report	181
How to Turn on and Configure Automatic Printing of Chip Run Reports	185
Configuring Tables	187
Configuring...	188

This chapter shows you what to do to open, save, import and export files, and how to print the results.



## Working with Chip Data and Methods/Assays

You can make efficient use of the chip and method/assay data generated by the 2100 Expert Software, if you know the following fundamentals and operating techniques:

- “[2100 Export Data Overview](#)” on page 159
- “[Handling Methods](#)” on page 162
- “[Handling Chip Data](#)” on page 166
- “[Organizing, Backing up, and Archiving 2100 Expert Data](#)” on page 167
- “[Importing Data](#)” on page 169
- “[Exporting Data](#)” on page 173
- “[Printing Reports](#)” on page 180
- “[Configuring Tables](#)” on page 187

### NOTE

The 2100 Expert Security Pack restricts access to data and functionality to users who are logged in with certain roles. See *User Role Model* (“[Access Control](#)” on page 39) for details.

---

## 2100 Export Data Overview

The 2100 Expert Software manages data in the following different formats:

- Method/assay files (.xsy)
- Chip data files (.xad)
- Comparison files (.xac)
- Verification result files (.xvd)
- Diagnostics result files (.xdy)
- Result flagging rule files (.xml)

### Method/Assay files

Method/Assay files (.xsy) contain the following information:

- Data acquisition and analysis setpoints  
Acquisition setpoints are instrument commands and acquisition parameters. Analysis setpoints are evaluation parameters, some of which you can modify.
- Method/Assay information  
All parameters defined by the method/assay, such as method/assay type, title, and version.  
This information includes:
  - Method/Assay type, title, version, and all other parameters defined by the method/assay.
  - Study configuration
  - Instrument configuration
  - Reporting configuration
  - Workflow configuration
- Chip and sample information  
These are sample names, sample and chip comments, and lot numbers.
- Ladder table and peak table
- Result flagging rules
- The audit trail and the signature log with all signatures of the involved users.

#### Chip data files

Chip data files (.xad) contain the following information:

- Measurement results

After each chip run, the measurement results—also called “raw data”—are automatically saved in a new chip data file. Electrophoretic measurement results are pairs of migration time and fluorescence intensity values.

- Base method/assay information

Because a chip run is always based on a method/assay file, *all* information from the method/assay file becomes part of the chip data file.

- Run log

Events occurring during the chip run, such as the start and end time, or any errors or problems are entered in a “run log”, which is also saved in the chip data file.

- Evaluation information

These are modifications you made during data evaluation, such as modified gel coloring, manually set markers, manual integration, modified setpoints, modified result flagging rules, or definitions of new markers and regions.

- The audit trail and the signature log with all signatures of the involved users

#### Comparison files

You can compare the measurement results from different chip runs (data files of same method/assay class only) by collecting samples from different chip data files (.xad) and storing them in a comparison files (.xac). It is then possible to overlay electropherograms of these samples, for example, but also to compare gel-like images or data tables.

Comparison files also contain an audit trail and a signature log with all signatures of the involved users.



### **Verification result files**

Verification result files (.xvd) contain results of qualification tests regarding the 2100 Bioanalyzer system hardware and software. The files are stored in the “..\validation” subfolder of the 2100 Expert Software installation directory. For each verification run, an .xvd file is generated.

Date and time of the verification run are included in the file name. Example: “Verification\_23-05-2005\_10-28-40.xvd”.

Verification files also contain an audit trail and a signature log with all signatures of the involved users.

### **Diagnostics result files**

To ensure proper functioning of the 2100 Bioanalyzer instrument you should run hardware diagnostics tests on a regular basis. The results of these hardware tests are stored in diagnostics results files (.xdy) in the “..\diagnosis” subfolder of the 2100 Expert Software installation directory.

### **Result flagging rule files**

You can export and import result flagging rules from other method/assay or chip data files. Result flagging rules are stored in .xml files.

## Handling Methods

### Method Templates

The 2100 Expert Software provides method templates. They are designed for measurements using the available kits. They are not suited to be run directly, but must be adapted into custom methods. For example, a necessary adaptation for these methods might be to add an instrument.

### Predefined Assays

Predefined assays are provided with 2100 Expert Software. They are meant and prepared for measurements using the available Analysis kits.

Predefined assays such as DNA 1000 are write-protected. Although you can open predefined .xsy files and edit some of their properties, you cannot save any changes under the original file name.

### Methods

You can derive your own methods from the predefined methods as described in [“How to create a custom method:”](#) on page 163.

The main benefit of custom methods is that you have to do the following only once in the method file, instead of doing it again and again in the chip data files:

- Enter the general properties of the method such as the configuration of study, instrument, reporting, and workflow.
- Modify method setpoints (data analysis setpoints).
- Enter information on chip and samples.

For example, if your sample names are to be the same for a series of chip runs.

- Define rules for result flagging.

#### NOTE

When creating a method from a template or from a pre-existing method, it initially has the state *method development*. The user who saved it as a new method, will automatically be set up as an analyst in the workflow. In this state only he/she can run the method after adding an instrument. This way the method can be tested without the need to change the state to *ready to use*.

You can modify methods at any time. See “[How to modify a custom assay method](#)” on page 165.

**NOTE**

If you just want to view the properties of a method, you can open the method file in read-only mode, ensuring you do not make accidental changes.

---

**How to create a custom method:****NOTE**

The 2100 Expert Security Pack restricts access to data and functionality to users who are logged in with certain roles. See *User Role Model* (“[Access Control](#)” on page 39) for details.

---

**To create a method:**

- 1 Switch to the **Method** context.
- 2 From the **Methods** menu, select a method.  
OR  
Select File > Open and open a method (.xsy) file.  
The file appears in the **TreeView Panel**.
- 3 Switch to the **General Properties** tab to specify the **Study Configuration** settings.
  - To add a new study to the list of studies, click **Add**. Then fill the remaining fields.
  - To modify the settings of an existing study, select it from the list, click **Modify** and edit the fields in question.
- 4 On the **Instrument Configuration** sub-tab, you see a list of all validated instruments.
  - Select the instruments allowed for this method and click the **Add** button to move them to the list of **Allowed Instrument Configurations**.
  - To remove an instrument from this list, select it and click the **Remove** button.

**NOTE**

You can also import the instrument settings from another method file (for example, a similar method). Click the **Import** button and select the method file to be used.

---

## 5 Working with Chip Data and Methods/Assays

### Handling Methods

- 5 On the **Reporting Configuration** sub-tab, define the items that are to be included in the report.

#### NOTE

You can also import the report settings from another method file (for example, a similar method). Click the **Import** button and select the method file to be used.

---

- 6 Switch to the **Assay Properties Tab** to modify the method setpoints if required.
- 7 Switch to the **Chip Summary Tab** to enter chip and sample information.
- 8 Define flagging rules on the **Result Flagging Tab**.
- 9 Select **Save As** from the **File** menu.  
The **Save As** dialog box appears.
- 10 Under **Save as type**, select **(.xsy)**, and enter a name and location for the new method.
- 11 To create the new method, click **Save**.
- 12 You need to confirm this action with your electronic signature.

#### NOTE

When creating a method from a template or from a pre-existing method, it initially has the state *method development*. The user who saved it as a new method, will automatically be set up as an analyst in the workflow. In this state only he/she can run the method after adding an instrument.

---

#### NOTE

This way the method can be tested without the need to change the state to *ready to use*. In this state the method can also be run on instruments that are not validated.

---

## How to modify a custom assay method

To modify a custom assay method:

### NOTE

You cannot save modifications to predefined assays method templates.

### NOTE

The 2100 Expert Security Pack restricts access to data and functionality to users who are logged in with certain roles. See *User Role Model* (“[Access Control](#)” on page 39) for details.

- 1 From the **File** menu select **Open**.  
The **Open** dialog box appears.
- 2 Select a method (.xsy) file and click **Open**.  
The method appears in the TreeView Panel and the **Assay Properties** Tab is displayed.
- 3 Modify the method by making changes on the following tabs:
  - Modify study, instrument, reporting, and workflow settings on the **General Properties** Tab.

### NOTE

The study description is stored in the 2100 Expert system file. Altering the study description of a method will not affect the entries in the data files that were previously generated from this method. To update this information in the data files, too, they must be opened, and the study must be assigned again.

- Modify method setpoints on the **Assay Properties** Tab.
  - Modify or enter additional chip, sample, and study information on the **Chip Summary** Tab.
  - Define or modify flagging rules on the **Result Flagging** Tab.
- 4 If the method is now completely set up, switch back to the **General Properties** tab and click the **Release for use** button.
  - 5 From the **File** menu select **Save** to save the method with the current name or **Save as** to save it with a new name.  
You need to confirm this action with your electronic signature.

## Handling Chip Data

Chip data (.xad) files are automatically generated at the end of a chip run. The .xad files are given names that correspond to the choices you have made in the **Options** dialog box (see “[How to Specify Data File Names and Directories](#)” on page 207).

### Modifying and saving chip data files

2100 Expert Software allows to re-open chip data files, reanalyze them using different evaluation parameters and store the new results. You can save modifications either to the original file (**File > Save**) or under a new file (**File > Save As**).

#### NOTE

Raw data acquired from the 2100 Bioanalyzer system is *not* changed—only evaluation and display of the results can be changed and saved.

If you alter the data shown in any way after it has been saved and try to exit the program or switch to a different context (to acquire new data, for example), a dialog box will appear asking whether or not you wish to save the changes.

### Opening chip data files as read-only

A chip data file can be opened as read-only; the **Title Bar** will show “(Read-Only)” at the end of the filename. The read-only file can be edited but may not be saved under the same name. If you attempt to save an edited read-only file, an error message will be displayed explaining that the file is a read-only file.

The benefit of opening chip data files as read-only is to prohibit you or other users from making changes that would alter the file in any way. Because the 2100 Expert Software allows you to open chip data files, modify data, and save them, you may prefer to ensure that the original parameters that were used to create the file are not altered.

## Organizing, Backing up, and Archiving 2100 Expert Data

As you begin to work with the 2100 Expert Software, it is good practice to organize your files. If you are not the only user of the bioanalyzer, creating a directory within which to save your files is recommended; having each person save files to their own directory will speed the process of finding a particular file when someone wishes to examine the data again. Even if only one person uses the 2100 Expert Software, it is still wise to review your files periodically, archive files you are no longer using but wish to save, and discard unneeded files.

With the Security Pack installed, the 2100 Expert Software takes this task over from you and saves all the created data files in the **Secured Area** directory. In the data folder you will find folders for each assay class and each assay subclass. Underneath each assay subclass you can find a folder for each method and finally in this method folder you will find a folder for each data file created on your system.

### Organizing 2100 Expert Data

Each user in your laboratory may want to specify a particular prefix that will easily differentiate their data files from any others.

To do this, switch to the **System** context, go to the **System Wide Settings** tab, and select **Data Files** in the tree navigation. Then activate the **Prefix** check box, and edit the prefix string as you require. Note that you can also modify the file prefix before you start a chip run. Additionally, you may specify that a new directory is created each day for storage of that day's runs. To do this, activate the **Create Daily Subdirectories** check box on the same screen.

You can specify the file prefix every time before you start a chip run in the Instrument context.

### **Backing up 2100 Expert Data**

It is strongly recommended to save your files to a backup drive or on CD/DVD on a regular basis. This allows to retrieve the data in case of a system crash or other cases of data loss. For users of the 2100 Expert Security Pack, data backup is in the responsibility of the backup operators or the 2100 Administrators. 2100 Expert Software provides these users with the rights to access the **Secured Area** of the file system with the Windows Explorer and backup tools for this purpose.

### **Archiving 2100 Expert Data**

The difference between archiving and backing up is that in the archiving process the data will be removed from its original place and moved while during the backup process only a copy is taken (depending on the tools you use).

It is a good idea to periodically archive your files to a CD/DVD to remove them from your hard disk. Depending on the amount of hard disk space available to the 2100 Expert Software, you may need to clear space on your hard drive to ensure that you will have enough room to save upcoming chip run data.

For users of the 2100 Expert Security Pack, archiving is done by the backup operators or the 2100 Administrators. 2100 Expert Software provides archiving functionality to users with either of these roles. Additionally, these users have the rights to access the secured area of the file system with the Windows explorer and tools for this purpose.

See “[Archiving Data](#)” on page 217 for details.



## Importing Data

When working with method/assay (.xsy) or chip data (.xad) files, you enter specific information that you may want to reuse. To support the reuse of data, 2100 Expert Software has the following import capabilities:

- “[Importing 2100 Bioanalyzer System Files](#)” on page 169
- “[Importing Data Analysis Setpoint](#)” on page 170
- “[Importing Chip and Sample Information](#)” on page 171
- Batchwise importing files into a secured state (“[To import multiple 2100 Expert data files:](#)” on page 216)

You can import result flagging rules definitions for result flagging into electrophoretic method/assay or chip data files:

- “[Importing Result Flagging Rules](#)” on page 172

### Importing 2100 Bioanalyzer System Files

You can import data, assay and method files that were generated with other Agilent 2100 Bioanalyzer systems.

**NOTE**

The 2100 Expert Security Pack restricts access to data and functionality to users who are logged in with certain roles. See *User Role Model* (“[Access Control](#)” on page 39) for details.

---

### How to Import Assay, Method and Chip Data Files

#### To import assay or method files:

**NOTE**

Note that the imported files have the state *method development* and cannot be used directly for a measurement. If you imported an assay file that was generated with 2100 Expert Software without security pack, the missing information (such as allowed instruments or workflow information) has to be added. If you imported a method file from 2100 Expert Software with security pack, information such as the instrument to be used and the workflow settings need to be updated.

---

## 5 Working with Chip Data and Methods/Assays

### Importing Data

- 1 Switch to the **Method/Assay** context.
- 2 From the **File** menu, select **Import** to display the **Open** dialog box.
- 3 Select a .xsy (2100 Expert method/assay file) file.
- 4 Click **Open**.
- 5 You need to confirm this action with your electronic signature.

The imported file appears in the **Tree View Panel**, and the **Method Properties/Assay Properties** tab shows information about the method/assay.

Upon importing, the file gets converted to a new 2100 Expert method/assay file (.xsy).

#### To import chip data files:

- 1 Switch to the **Data** context.
- 2 From the **File** menu, select **Import** to display the **Open** dialog box.
- 3 Select a .xad (2100 Expert chip data file) file.
- 4 Click **Open**.
- 5 You need to confirm this action with your electronic signature.

The imported file appears in the **Tree View Panel**, and the electropherogram grid view shows an overview of all samples.

Upon importing, the file gets converted to a new 2100 Expert chip data file (.xad).

## Importing Data Analysis Setpoint

### Importing Data Analysis Setpoint

You can import data analysis setpoints from other method/assay (.xsy ) or chip data (.xad) files of the same type.

Note the following when importing:

- Electrophoresis files to be imported must be of the same assay/method type. This means that you cannot import setpoints from a DNA 1000 assay/method into a DNA 7500 assay/method, for example.

**NOTE**

The 2100 Expert Security Pack restricts access to data and functionality to users who are logged in with certain roles. See *User Role Model* (“[Access Control](#)” on page 39) for details.

---

**To import data analysis setpoints:**

- 1 On the **Assay Properties/Method Properties** tab, click **Import Setpoints**.  
The **Open** dialog box appears.
- 2 Select the file from which you want to import, and click **Open**.

**NOTE**

Importing data analysis setpoints *overwrites* all current setpoint values.

---

All files: the setpoint values are updated in the setpoint explorer, and immediately applied to the measurement results (if any).

- 3 From the **File** menu, select **Save** to make the changes permanent.

## Importing Chip and Sample Information

On the **Sample Information** and **Study Information** sub-tabs of the **Chip Summary** tab, you can enter names and comments regarding chip, samples, and study. The information you enter here may be very similar for further chip runs or other assays/methods. Once you have entered the information, you can export it into a separate file (see “[Export Chip Run Data](#)” on page 174), which you can then import into other chip data (.xad) or assay (.xsy) files instead of typing it anew.

The import/export files can have the extension .txt or .csv, and have a fixed form.

**NOTE**

The 2100 Expert Security Pack restricts access to data and functionality to users who are logged in with certain roles. See *User Role Model* (“[Access Control](#)” on page 39) for details.

---

### To Import Chip and Sample Information

- 1 On the **Chip Summary** tab, click **Import**.  
The **Import Sample Information** dialog box appears.
- 2 Select the file that contains the information you want to import, and click **Open**.  
The **Sample Information** and **Study Information** sub-tabs of the **Chip Summary** tab update to show the imported data.
- 3 From the **File** menu, select **Save** to make the changes permanent.

## Importing Result Flagging Rules

You can import result flagging rules into electrophoretic assay/method (.xsy) or chip data (.xad) files. Result flagging rules can be stored in.xml files (see “[Exporting Result Flagging Rules](#)” on page 179).

### NOTE

The 2100 Expert Security Pack restricts access to data and functionality to users who are logged in with certain roles. See *User Role Model* (“[Access Control](#)” on page 39) for details.

### To Import Result Flagging Rules

- 1 Open an electrophoretic assay/method or chip data file in the respective context.
- 2 Switch to the **Result Flagging** Tab.
- 3 In the **Result Flagging** toolbar click .  
The **Load Rules** dialog box appears.
- 4 Select the.xml file that contains the set of result flagging rules, and click **Open**.  
The imported rules are applied to the data of the assay or data file.

## Exporting Data

2100 Expert Software allows you to export the results of your chip runs in a variety of formats. The exported data can be used for further evaluation with other applications, such as text processors, graphic tools, or Microsoft Excel®. You can export the chip run data of the currently loaded file either manually or automatically:

- [“Export Chip Run Data”](#) on page 174

More powerful functions for exporting data files are found in the **System** context. See:

- [“To export multiple 2100 Expert data files:”](#) on page 215 for exporting multiple data files.
- [“Archiving Data”](#) on page 217 for archiving complete directories (data files and .PDF reports).

If you want to export only parts of your measurement results:

- [“Exporting Tables”](#) on page 176
- [“Exporting Graphs or Gel-like Images”](#) on page 177
- [“Copying Graphs, Gel-like Images and Tables into the Clipboard”](#) on page 178

Information that you have entered to document a chip run can be exported for reuse in future chip runs:

- [“Exporting Chip and Sample Information”](#) on page 174

From electrophoretic assay/method or chip data files, you can also export rule definitions for result flagging:

- [“Exporting Result Flagging Rules”](#) on page 179

### NOTE

The 2100 Expert Security Pack restricts access to data and functionality to users who are logged in with certain roles. See [“Access Control”](#) on page 39 for details.

## Exporting Chip and Sample Information

On the **Sample Information** and **Study Information** sub-tabs of the **Chip Summary** tab, you can enter names and comments for the chip and the samples. The information you enter here may be very similar for further chip runs or other methods/assays. Once you have entered the information, you can export it into a separate file, which you can then import into other chip data (.xad) or method/assay (.xsy) files instead of typing it anew.

The import/export files can have the extension .txt or .csv, and have a fixed form, which differs for electrophoretic assays.

To export chip and sample information to a file:

### NOTE

The 2100 Expert Security Pack restricts access to data and functionality to users who are logged in with certain roles. See *User Role Model* (“[Access Control](#)” on page 39) for details.

---

- 1 On the **Chip Summary** tab, click **Export**.  
The **Export Sample Information** dialog box appears.
- 2 Specify a file name and location for the file to which you want to export.
- 3 Click **Save**.

## Export Chip Run Data

### NOTE

The 2100 Expert Security Pack restricts access to data and functionality to users who are logged in with certain roles. See “[Access Control](#)” on page 39 for details.

---

- 1 Switch to the **Data** context.
- 2 In the **Tree View Panel**, select a chip data (.xad).file or load a file.
- 3 From the **File** menu, select **Export**.  
The **Electrophoresis Export Options** dialog box appears.
- 4 Select the export categories, and specify a target directory.

**NOTE**

Keep in mind that exporting a chip data file can require up to 20 MB of disk space. In particular, exporting electropherograms and gel-like images as .tif or .bmp files may take up a lot of disk space.

---

**NOTE**

If you want to access these exported files and you do not have admin rights, please keep in mind to specify a target directory outside the **Secured Area** folder.

---

**NOTE**

Otherwise the data will get exported but you will not be able to access it with the Windows Explorer since access is only granted to 2100 Administrators and 2100 Backup Operators.

---

**5** Click **Export**.

Several system dialog boxes appear, one for each export category, allowing you to check and modify names and locations of the export files. Clicking the **Save** button in these dialog boxes finally starts the export.

**HINT**

Chip run data can be automatically exported every time a chip run has finished. Refer to [“Exporting Chip Run Data Automatically”](#) on page 176 for details.

---

**6** Confirm this action with your electronic signature.

Several system dialog boxes appear, one for each export category, allowing you to check and modify names and locations of the export files.

**NOTE**

Chip run data can be automatically exported every time a chip run has finished. Refer to [“Exporting Chip Run Data Automatically”](#) on page 176 for details.

---

The **Export** tab of the **System** context allows you to export multiple data files without having to load them first.

See [“To export multiple 2100 Expert data files:”](#) on page 215 for details.

## Exporting Chip Run Data Automatically

### NOTE

Keep in mind that exporting a chip data file can require up to 20 MB of disk space. In particular, exporting electropherograms and gel-like images as .tif or .bmp files may take up a lot of disk space.

---

### NOTE

The 2100 Expert Security Pack restricts access to data and functionality to users who are logged in with certain roles. See *User Role Model* (“[Access Control](#)” on page 39) for details.

---

- 1 Switch to the **System** context and select **Auto Export** in the tree navigation.
- 2 Activate the **Auto Export** check box.
- 3 Specify the export categories that are to be included in the exported files.
- 4 Switch to **Default Export Directories** in the tree navigation and specify the target directories.
- 5 To leave the **System** context, you need to confirm this action with your electronic signature.

From now on, chip run data is automatically exported every time a chip run has finished.

### NOTE

If you stop a chip run, auto export does *not* take place.

---

## Exporting Tables

You can export:

- Result, peak, fragment, region, and ladder tables as .csv files or .xls files.
- Log book tables as .html or .txt files.

### NOTE

The 2100 Expert Security Pack restricts access to data and functionality to users who are logged in with certain roles. See *User Role Model* (“[Access Control](#)” on page 39) for details.

---



**To export a result, peak, fragment, region or ladder table:**

- 1 On the **Assay Properties/Method Properties, Electropherogram, or Gel** tab, right-click the heading row of a table.
- 2 From the context menu, select **Export**.  
The **Export Data** dialog box appears.
- 3 Enter a file name and choose the destination directory.
- 4 Select **.csv** or **.xls** as export file format.
- 5 Click **Save**.

**NOTE**

Result tables can be automatically exported every time a chip run has finished. Refer to “[Exporting Chip Run Data Automatically](#)” on page 176 for details.

---

**To export a log book table:**

- 1 On the **Log Book** tab, right-click a table.
- 2 From the context menu, select **Export**.  
The **Export Data** dialog box appears.
- 3 To specify the file name, the destination directory, and the file type, click the **...** button. You can choose between **HTML file** for *.html* output and **Tabbed text file** for *.txt* output.
- 4 Specify whether you want to export the **Selected rows only** or **All visible rows**.
- 5 Click **OK**.

**Exporting Graphs or Gel-like Images**

You can export graphs or gel-like images as individual graphic files.

**NOTE**

The 2100 Expert Security Pack restricts access to data and functionality to users who are logged in with certain roles. See *User Role Model* (“[Access Control](#)” on page 39) for details.

---

**To export a graph or a gel-like image:**

- 1 Right-click the graph and select the appropriate entry (e.g. **Save Gel** or **Save Electropherogram**) from the **Context** menu.

OR

Click the  button in the toolbar.

The **Save As** dialog box appears.

- 2 To enter a name and choose the destination directory, click **File name**.
- 3 To select a graphic file format: .bmp, .jpg, .wmf, .tif or .gif, click **Save as type**
- 4 Click **Save**.

The graph or gel-like image is written to the specified file.

Note the following:

Electropherograms:

if the grid view is active, an overview image of the electropherograms (of *all* samples and the ladder) is exported.

**HINT**

Electropherograms and gel-like images can be automatically exported every time a chip run has finished. Refer to “[Exporting Chip Run Data Automatically](#)” on page 176 for details.

## Copying Graphs, Gel-like Images and Tables into the Clipboard

You can copy graphs and gel-like images into the clipboard. This applies to most graphs that can be displayed in the 2100 Expert Software, such as electropherograms or standard curves.

You can also copy tables (or parts of tables) into the clipboard. This applies to most of the tables that can be displayed in 2100 Expert Software, such as result tables or log book tables.

To copy a graph, gel-like image or table into the clipboard:

**NOTE**

The 2100 Expert Security Pack restricts access to data and functionality to users who are logged in with certain roles. See *User Role Model* (“[Access Control](#)” on page 39) for details.

- 1 Right-click the graph, gel or table.
- 2 From the context menu, select **Copy Gel/Copy Electropherogram** or **Copy To Clipboard** (tables).

OR

Click the  button in the toolbar.

You can now switch to a word processing, spreadsheet, graphics, or other application, and paste the graph/gel or table there.

### Exporting Result Flagging Rules

You can export result flagging rules for reuse in other electrophoretic assay/method (.xsy) or chip data (.xad) files (see [“Importing Result Flagging Rules”](#) on page 172). Result flagging rules are stored in.xml files.

To export result flagging rules:

#### NOTE

The 2100 Expert Security Pack restricts access to data and functionality to users who are logged in with certain roles. See *User Role Model* (“[Access Control](#)” on page 39) for details.

- 1 Open the electrophoretic assay/method or chip data file with the desired result flagging rules in the respective context.
- 2 Switch to the **Result Flagging** tab.
- 3 In the **Result Flagging** toolbar click the icon  (Export Rules to File).  
The **Save Rules** dialog box appears.
- 4 Browse for a folder where you want to store the rules, and specify a name for the.xml file.
- 5 Click **Save**

## Printing Reports

For documentation and presentation purposes, you can print reports for method/assay (.xsy), chip data (.xad), verification results (.xvd), and comparison (.xac) files.

You can print all reports manually, see [“How to Print a Chip Run Report”](#) on page 181. When printing manually, a preview function allows you to view the printout before starting the print job.

The 2100 Expert Software can also be set to print customized chip run reports automatically at the end of the run. These reports can be set up to contain different information (settings for the manual and automatic print functions are maintained separately). See [“How to create a custom method:”](#) on page 163 for more information.

The 2100 Expert Software can also be set to print customized chip run reports automatically at the end of the run. These reports can be set up to contain different information (settings for the manual and automatic print functions are maintained separately). See [“How to Turn on and Configure Automatic Printing of Chip Run Reports”](#) on page 185 for more information.

### HINT

Beside sending reports to a printer, you can also create .pdf and .html files.

## How to Print a Chip Run Report

The following information can be included in a chip run report:

- You can always include:
  - Run summary—general data about the method/assay, and sample information.
  - Assay details—complete list of data analysis setpoints.
  - Run Logbook
  - Signature Logbook
  - Audit Trail
- For *electrophoretic* chip data files (.xad), depending on the method/assay type you can include:
  - Electropherograms
  - Gel-like image
  - Result tables
  - Standard curve
  - Calibration curve

To print a report:

### NOTE

The contents of the report are specified during the method/assay setup. If a chip run was made based on a method/assay that was released for use, you cannot alter the pre-defined contents of the report.

- 1 Switch to the **Data** context.
- 2 In the **Tree View Panel** select the chip data (.xad) file you want to generate a report of.

## 5 Working with Chip Data and Methods/Assays

### Printing Reports

#### 3 From the **File** menu select **Print**.

Depending on the file type different dialog boxes appear.

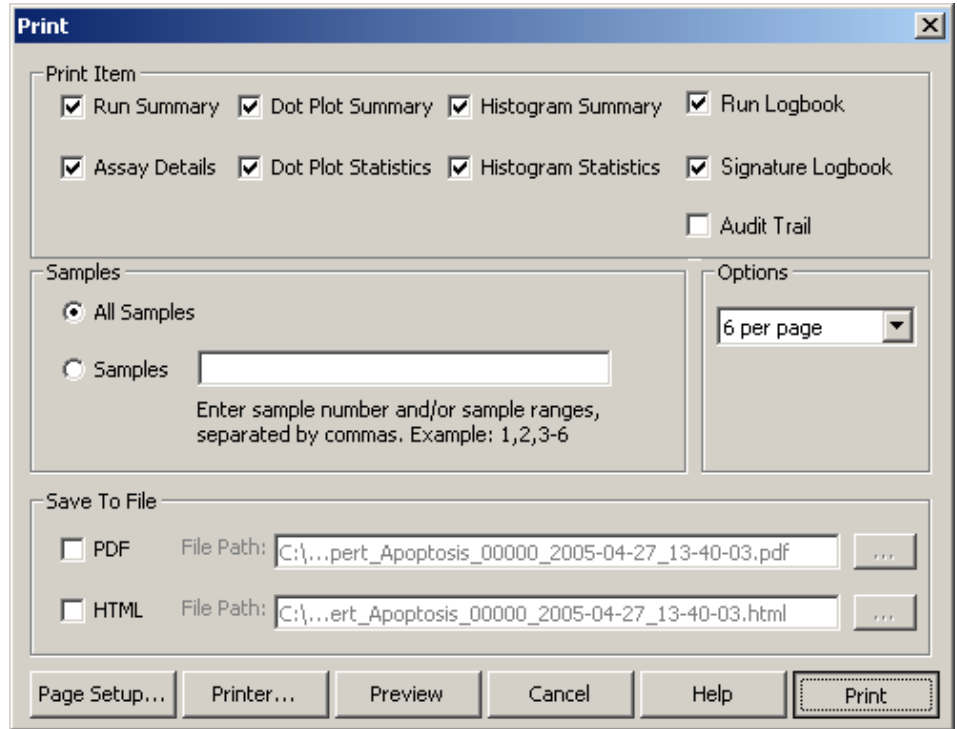

- 4** You generally have the following possibilities:
  - select the items to be included in the report from the **Print Item** section
  - select the wells to be included from the **Wells** (electrophoretic assays) section
  - select the appropriate options
  - specify whether you want to generate the report as a file (PDF or HTML) and specify the file path

**NOTE**

**Security Pack:** You can only select the included Print Items and the additional Options only unless the method is released for use.

---

**NOTE**

Your selections here are separate from the **Auto Print** selections (they do not affect each other). Both are used by default the next time you print (even after restarting the program).

---

- 5** Use the **Page Setup** and **Printer** buttons to access system dialog boxes, allowing you to select a printer, and specify the print medium and page layout.
- 6** To get a preview of the printouts or files to be generated, click the **Preview** button.
- 7** To print out the pages or generate the file(s), click **Print**.

The following example shows the “Run Summary” part of an RNA chip run report.

## 5 Working with Chip Data and Methods/Assays Printing Reports

2100 expert\_mRNA Pico\_00000\_2005-05-17\_15-59-32.xad (V. 1)

Page 1 of 16

Assay Class: mRNA Pico  
Data Path: C:\...NA Pico\2100 expert\_mRNA Pico\_00000\_2005-05-17\_15-59-32.xad

Read: 17.05.2005 15:59:41  
Modified: 17.05.2005 16:02:27

### Electrophoresis File Run Summary

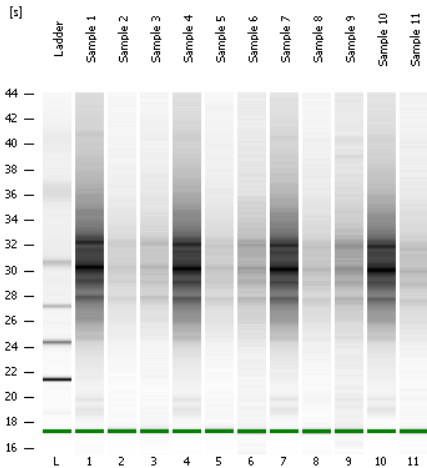

#### Instrument Information:

Instrument Name: N/A  
Serial#: N/A  
Firmware: Simulation Mode  
Type: UNKNOWN

#### Assay Information:

Assay Origin Path: C:\Programme\Agilent\2100 bioanalyzer\2100 expert\SecuredArea\Method\Demo Templates\RNA\Demo mRNA Pico.xad  
Title: Demo mRNA Pico  
Version: 1.0  
Ladder Concentration: 1000,00  
Start Time: 15,00  
End Time: 84,00  
Sizing Accuracy: 15  
Quantitation Accuracy: 30  
Assay Comments: Copyright © 2003 Agilent Technologies

#### Chip Information:

Chip Lot:  
Reagent Kit Lot:  
Chip Comments:

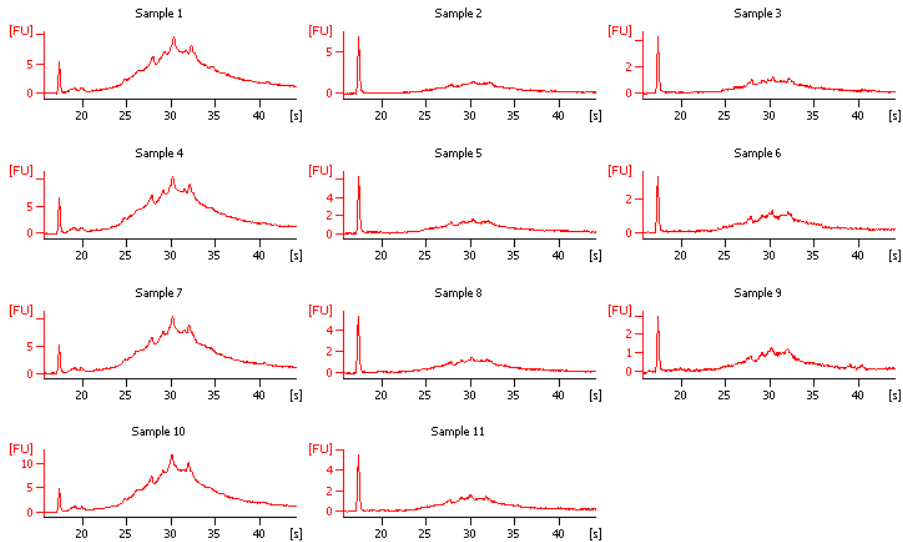

2100 expert (B.02.01.SI211)

© Copyright 2003-2005 Agilent Technologies, Inc.

Printed: 17.05.2005 16:07:10



## How to Turn on and Configure Automatic Printing of Chip Run Reports

A report can be automatically printed on a printer or generated as a file at the end of each chip run. Saving reports as files can be helpful for documentation purposes.

**To enable and configure automatic printing:**

- 1 Switch to the **System** context.
- 2 Select **Run and Result** in the tree navigation.
- 3 Activate the **Auto Print** check box and click the **Settings** button next to this check box.

The **Auto Print** dialog box appears.

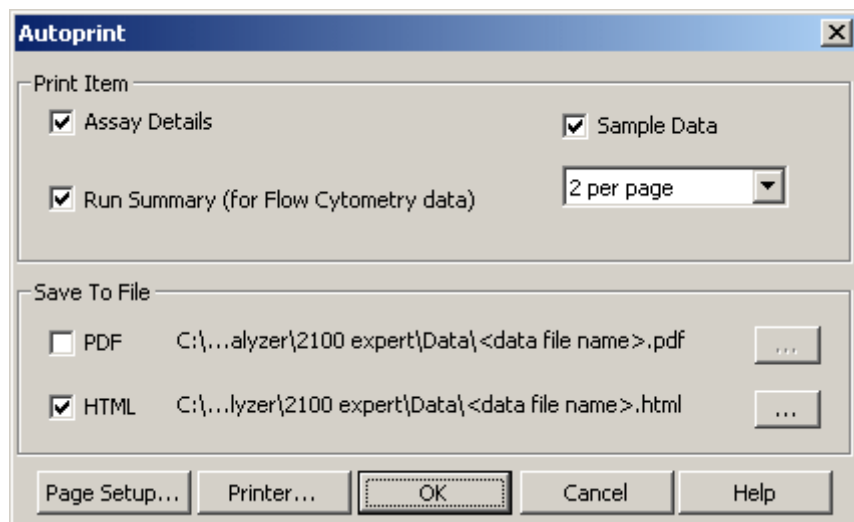

### NOTE

The **Auto Print** settings are independent from those made via the **Print** command of the **File** menu.

## 5 Working with Chip Data and Methods/Assays

### Printing Reports

#### 4 Adjust the settings:

- In the **Print Item** section, select the options that are to be included in the report.
- In the **Save To File** section, you can redirect the automatic printouts to .pdf and .html files.

Note that no print output is generated if you select the **PDF** and/or **HTML** option.

- Using the **Page Setup** and **Printer** buttons, you can access system dialog boxes, allowing you to select a printer for the automatic print, and specify the print medium and page layout.

#### 5 Click **OK** to confirm the automatic print settings.

## Configuring Tables

2100 Expert Software uses various tables to present data:

- Result tables
- Peak tables
- Fragment tables
- Region tables
- Log book tables

In some cases, you might want to reorganize the way the data is presented. To do so, you can hide or show columns, change the column sequence, and adapt the table height.

	Area	FragmentSize	Concentration	Molarity	Observations	
1	50.29	15.00	4.20	424.24	CalculatedLowerMarker	
2	29.49	472.30	0.76	2.45		
3	13.40	500.66	0.34	1.03		
4	84.13	1500.00	2.10	2.12	CalculatedUpperMarker	

The following example demonstrates how to add the migration time to the **Peak Table**.

### NOTE

The 2100 Expert Security Pack restricts access to data and functionality to users who are logged in with certain roles. See *User Role Model* (“[Access Control](#)” on page 39) for details.

## Configuring...

### Showing and Hiding Columns

To add the **Aligned Migration Time** column to the table:

- 1 Right-click the heading row of a table and select **Configure Columns** from the context menu.

The **Configure Columns** dialog box opens:

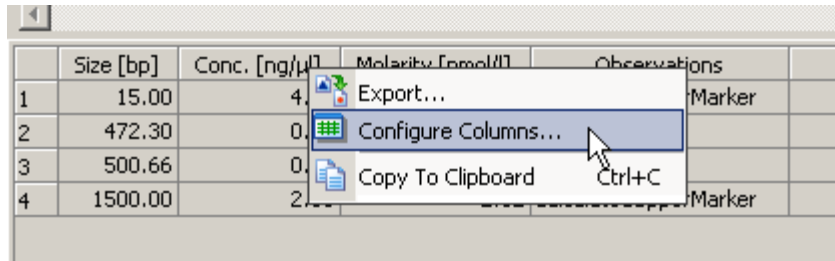

- 2 Move any desired column headers from the **Available** list to the **Displayed** list.

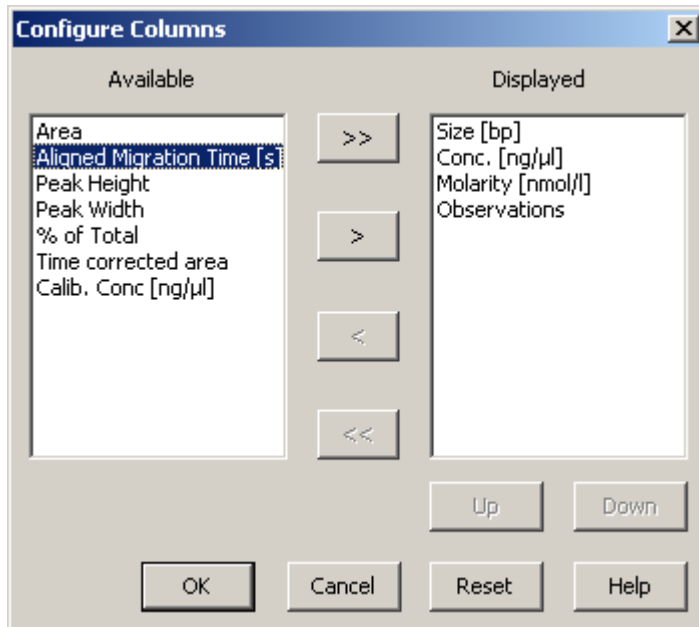

- 3 Configure the order of the column headers in the **Displayed** list by using the **Up** and **Down** buttons.

4 Click **OK**.

A new column **Aligned Migration Time** is inserted in the table:

	Size [bp]	Conc. [ng/μl]	Molarity [nmol/l]	Observations	Aligned Migration Time [s]
1	15	4.20	424.2	Lower Marker	41.00
2	22	1.55	105.6		42.72
3	55	1.23	33.8		47.44
4	104	3.90	56.7		53.04

**To change the column sequence of a table:**

**NOTE**

You can set the column sequence also using the **Up** and **Down** buttons in the **Configure Columns** dialog box.

- 1 Position the mouse pointer on a column header.
- 2 Click and hold the left mouse button to drag the header cell to the desired position.

While dragging, a green arrow indicates the target position.

	Area	FragmentSize	MigrationTime	Concentration	Molarity	Observations	MigrationTime
1	50.29	15.00	44.14	4.20	424.24	CalculatedLowerMarker	44.14
2	29.49	472.30	93.54	0.76	2.45		93.54
3	13.40	500.66	95.53	0.34	1.03		95.53
4	84.13	1500.00	115.56	2.10	2.12	CalculatedUpperMarker	115.56

- 3 Release the mouse button.

The column has moved to its new position:

	Area	FragmentSize	MigrationTime	Concentration	Molarity	Observations
1	50.29	15.00	44.14	4.20	424.24	CalculatedLowerMarker
2	29.49	472.30	93.54	0.76	2.45	
3	13.40	500.66	95.53	0.34	1.03	
4	84.13	1500.00	115.56	2.10	2.12	CalculatedUpperMarker

## 5 Working with Chip Data and Methods/Assays

### Configuring Tables

#### To increase or reduce the column width:

You can customize the view by changing the column width.

- 1 Position the mouse pointer between two columns and move it until the cursor's shape changes to a double arrow.
- 2 Click and hold the left mouse button and drag left or right.

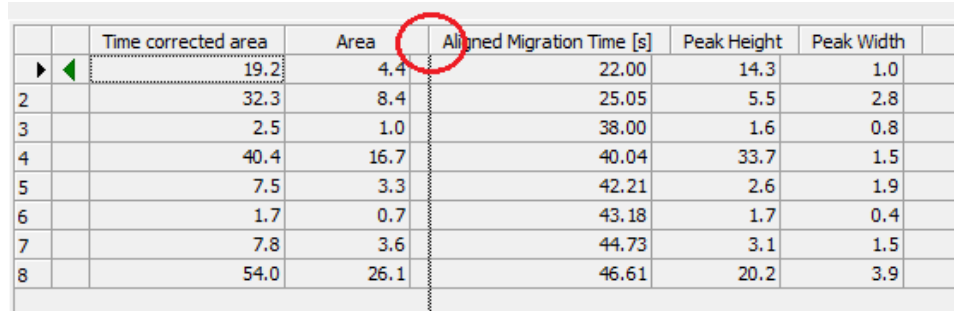

	Time corrected area	Area	Aligned Migration Time [s]	Peak Height	Peak Width
1	19.2	4.4	22.00	14.3	1.0
2	32.3	8.4	25.05	5.5	2.8
3	2.5	1.0	38.00	1.6	0.8
4	40.4	16.7	40.04	33.7	1.5
5	7.5	3.3	42.21	2.6	1.9
6	1.7	0.7	43.18	1.7	0.4
7	7.8	3.6	44.73	3.1	1.5
8	54.0	26.1	46.61	20.2	3.9

- 3 Release the mouse button.

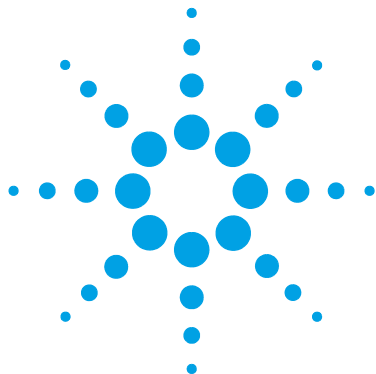

## 6 Administering System Functions and the Security Pack

Administering System Functions and the Security Pack	192
Access Control	193
How 2100 Expert Software Manages Users and Data Access	193
Managing User Accounts and Roles	194
Pre-configurations for the 2100 Expert Software	198
Setup a default printer	198
Default Printer margins	199
Configure regional settings	202
Display settings	205
USB-to-Serial adapter configuration	206
Configuring the 2100 Expert Software	207
How to Configure the 2100 Expert Software	207
Exporting and Importing Multiple Data Files	215
Exporting and Importing Multiple Data Files	215
Archiving Data	217
Archiving Data	217
Using Log Books	220
How to change the display of the logbooks	224
How to Search the Log Book	226

This chapter is your guideline for configuring the 2100 Expert Software.



## Administering System Functions and the Security Pack

The 2100 Expert Software provides the following configuration options and system functions:

- Users can be added, removed, and assigned various roles. See [“Access Control”](#) on page 193 for details.
- Default data file names and directories can be specified. Also, settings such as for automatic printing or automatic data export can be set up. See [“Configuring the 2100 Expert Software”](#) on page 207 for details.
- Chip data files can be exported and imported. See [“Exporting and Importing Multiple Data Files”](#) on page 215 for details.
- Data can be archived to free system space. See [“Archiving Data”](#) on page 217 for details.
- Log books are provided that record all important actions and messages in the 2100 Expert Software. See [“Using Log Books”](#) on page 220 for details.

### NOTE

The 2100 Expert Security Pack restricts access to data and functionality to users who are logged in with certain roles. See *User Role Model* ([“Access Control”](#) on page 39) for details.

---



## Access Control

Among others, the 2100 Expert Software with the Security Pack license provides functionality for access control. With this access control functionality, only authenticated and authorized users can access and modify data, i.e. any electronic record created or managed by 2100 Expert Security Pack.

### How 2100 Expert Software Manages Users and Data Access

2100 Expert Security Pack does not add another level of user management. It utilizes the user accounts setup which is managed by the operating system. The users can either be managed locally (user accounts on the computer) or in a company environment (user accounts managed by a directory service).

Analogously, password management is taken from the Windows operating system. The requirements in respect to user and password management posed in controlled environments, must be achieved by configuring the operating system account and password policies accordingly.

However, not all the users set up at the local PC or domain service are allowed to access the 2100 Bioanalyzer System. During its setup, the 2100 Expert Software will be configured to grant access only to those operating system users, which have been selected by a 2100 administrator.

Here it is also defined, which data and functionality a user is allowed to access. The 2100 Expert Software uses *roles* to determine which data and functions a user is allowed to access. Unless a user has already been assigned a particular role within the 2100 Expert Software, this user has no access to the 2100 Expert data.

There are direct consequences for a user management that is performed by the operating system: When a user changes his/her password within the company's directory service, this new password is also valid for the 2100 Expert Software.

To protect the data generated with the 2100 Bioanalyzer System from access via the Windows environment, a so-called **Secured Area** is defined. The **Secured Area** is a file directory where all Security Pack data gets stored in. It is defined as a folder belonging to the generic 2100 System account. This account performs the underlying security management tasks and is not visible inside the 2100 Expert Software. The System account is not assigned to any roles.

As a consequence the data in the **Secured Area** is controlled by the 2100 Expert Software. Access to the directory through Windows Explorer should only be granted via the software provided user roles "Administrator" and "Backup Operator" as this is recorded in the audit trail. Other users, including Windows users are not granted access to the secured data.

As an example, you may have a PC with 15 user accounts set up in the operating system plus the 2100 System account. Only 5 of these users are also set up as 2100 Expert Software users and, therefore, can access data through the 2100 Expert Software. But only one of them has the role 2100 Administrator and can, thus, access the data also with the Windows Explorer.

## Managing User Accounts and Roles

With the Security Pack license installed, the user management functions are activated. These functions are only available to users with the role *administrator*.

For more information on the various user roles, see *User Role Model* (“[Access Control](#)” on page 39).

### To Add a New User to the 2100 Expert Software:

- 1 Switch to the **System** context and go to the Users and Roles tab.
- 2 Select **Users and Roles > Add User**.

The **Select User** dialog box opens.

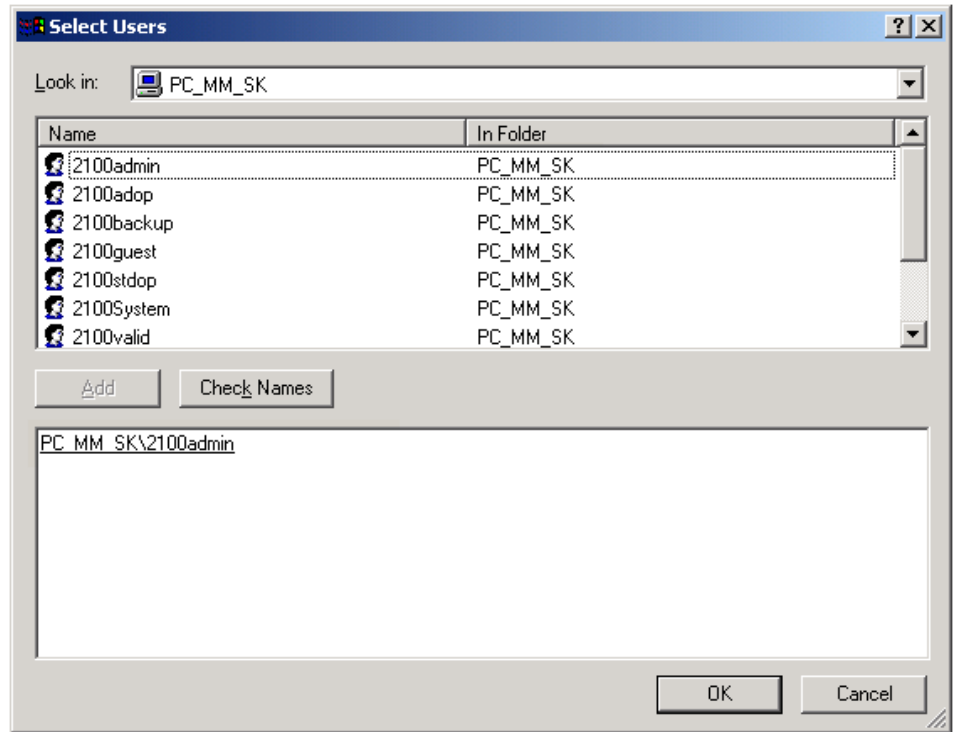

The appearance of this window depends on the installed operating system.

- 3 Select the user you want to add either from the local users or from your company's domain server.

**NOTE**

To select a user for 2100 Expert Software, his/her user account must already be set up in the operating system environment. This can only be done by an operating system administrator.

- 4 To add him/her to the list of selected users, click **Add**. You can add several users to this list.
- 5 To create user accounts for all selected users in the 2100 Expert Software, click **OK**
- 6 You need to confirm this action with your electronic signature.  
The new users now appear in the tree view panel.

### To assign roles to a user or to remove roles from a user:

- 1 Switch to the **System** context and go to the Users and Roles tab.
- 2 Click the name of the user in question in the tree view panel.  
The *User Information* of the selected user is displayed.
- 3 Check the roles that you want to assign to the user. Uncheck the rules that you want to remove from the user.
- 4 When leaving the **Users and Roles** tab, you need to confirm the changes with your electronic signature.

#### HINT

If you are unsure whether you selected the correct user in the tree view panel, you can click the **Full Name** button to retrieve the user's full name from the Windows user account.

### How to Enable and Disable a User Account

A 2100 Expert Software user account may be disabled. Two possible cases cause a 2100 Expert user account to be disabled:

- If the operating system user account is disabled, the respective 2100 Expert account is also disabled. This can happen, for example, due to several failed attempts to log into the operating system.
- The operating system user account may still be working, but the 2100 Expert account is disabled. The account could have been actively switched off by the 2100 administrator, if access for a certain user should be prohibited. Additionally, also 2100 expert may disable the account after too many failed attempts at login or signing.

A disabled account can only be enabled by a 2100 administrator. If the user account cannot be enabled again within 2100 Expert Software, the operating system administrator must check the user's account in the operating system and enable it again.

To enable or disable a user account within 2100 Expert Software:

- 1 The *User Information* including the current status of the selected user is displayed.
- 2 Switch to the **System** context and go to the Users and Roles tab.
- 3 To enable or disable a user account, right-click the user's name in the tree view panel and select the appropriate entry from the context menu.  
The status of the user changes accordingly.
- 4 When leaving the **Users and Roles** tab, you need to confirm the changes with your electronic signature.

## How to Change Your Password

If for security reasons a user needs to change the password immediately, for example if it has been spied upon, this can be done directly in the 2100 Expert Software.

To change your password:

### NOTE

The 2100 Expert Security Pack uses the user accounts from the Windows environment. Thus, changing your password from within the 2100 Expert Software will cause that this new password will also be required for future logins to the Windows operating system.

- 1 From the **File** menu in any context, select **Change Password**.

The Change Password dialog box opens.

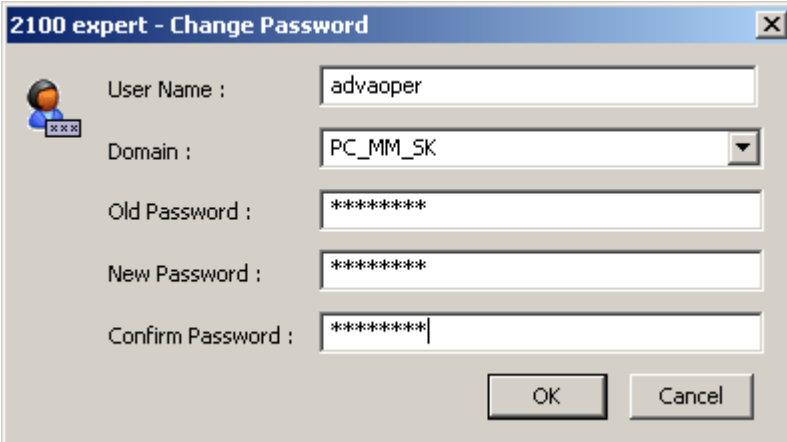

The screenshot shows a dialog box titled "2100 expert - Change Password". It features a user icon on the left. The fields are: "User Name" (advaoper), "Domain" (PC\_MM\_SK), "Old Password" (\*\*\*\*\*), "New Password" (\*\*\*\*\*), and "Confirm Password" (\*\*\*\*\*). "OK" and "Cancel" buttons are at the bottom right.

- 2 Enter your old password to authenticate yourself.
- 3 Enter the new password twice to verify the correct spelling.
- 4 To finish the password change, click **OK**.

## Pre-configurations for the 2100 Expert Software

### Setup a default printer

The 2100 Expert Software requires a printer to be setup for the printing of reports and for some software features, like result flagging, to function properly. This can either be a physical printer, connected to the PC or laptop the 2100 Expert Software is running on, a network printer or a virtual printers, like PDF or XPS printers.

To setup a printer on your PC or laptop, please follow the instructions below:

- 1 Windows 7 OS: To setup a default printer, log on to the operating system with an administrative account, select the **Start** button and then **Devices and Printers**. **Add** or select a printer, then select **Set as default printer**.

OR

Windows 10 OS: To setup a default printer, log on to the operating system with an administrative account, select the **Start** button and then **Settings**. Go to **Devices** and add or select a printer. Then select **Make default**.

#### NOTE

Security Pack Users: Please be aware that you have to setup a printer by logging into the generic 2100 System account. Then follow the instructions for your operating system.

## Default Printer margins

### NOTE

When working with 2100 Expert Software B.02.08 and Operating System Windows 7, certain page margins are not compatible with the document printer.

To modify the printer margins, please follow the instructions below.

### Configure XPS properties in Windows 7

- 1 In the 2100 Expert Software, open **File > Page setup**, then set the margins to 0.5 inches each and click **OK**. Make sure the paper size is **Letter** and **Source** is **Automatically Select**.

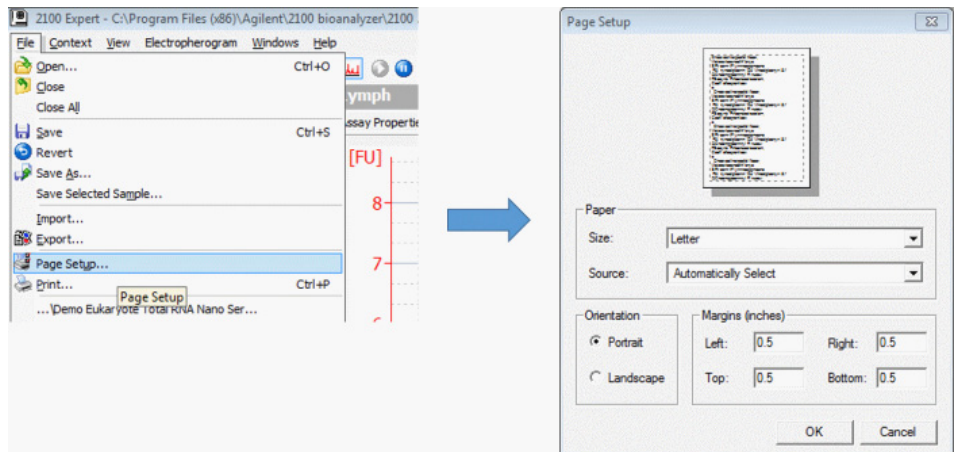

## 6 Administering System Functions and the Security Pack

### Pre-configurations for the 2100 Expert Software

- 2 Log on to the operating system with an administrative account, select the **Start** button and then **Devices and Printers**. Right click on **Microsoft XPS Document Writer**, select **Printing preferences**.

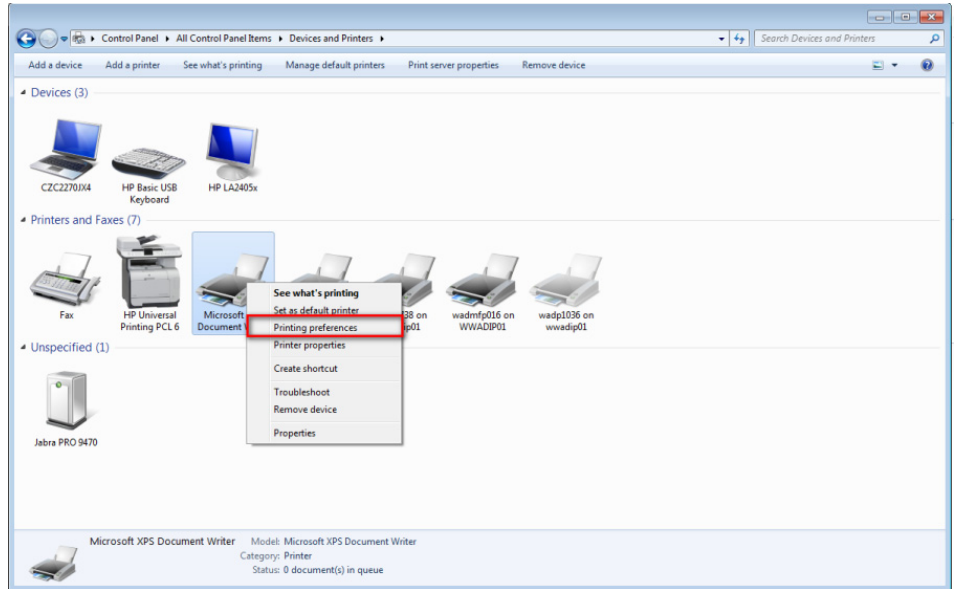



- 3 Select the **Layout** tab and choose **Orientation: Portrait**. Then click on **Advanced** and select **Paper/Output** and under **Paper Size** choose **Letter** and confirm with **OK**.

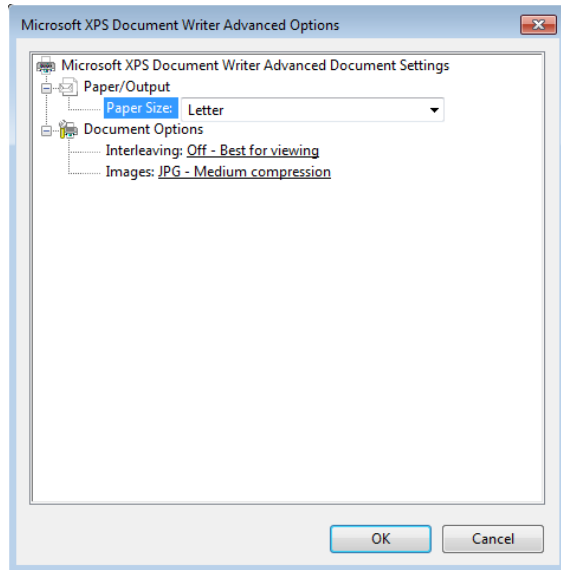

## Configure regional settings

### NOTE

Certain issues in the 2100 Expert Software can be solved by ensuring that your computer's regional and language settings are correct.

To review and change the regional settings please follow the instructions below.

- 1 Log on to the operating system with an administrative account, select the **Start** button and then **Control Panel**.

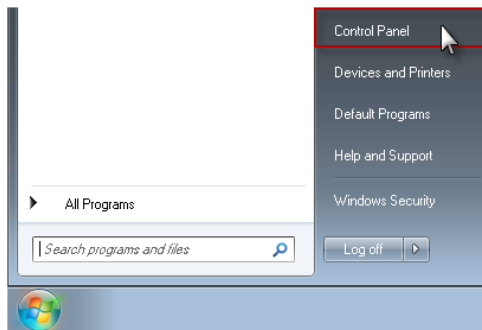

- 2 Select the **Clock, Language, and Region** category.

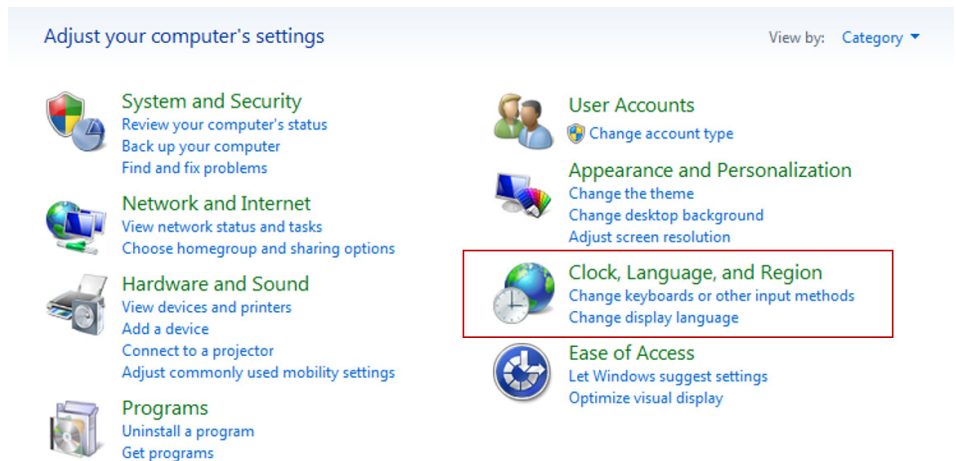

3 Select **Region and Language**.

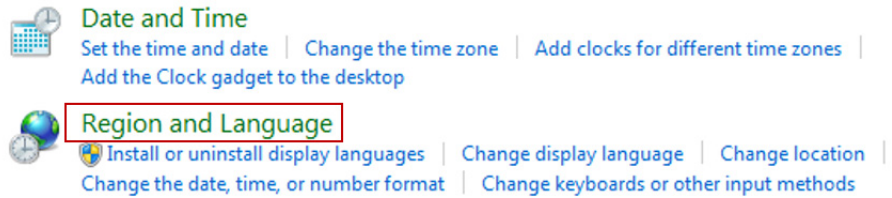

4 Ensure that the format is set to **English (United States)** and click on the **Additional Settings** button.

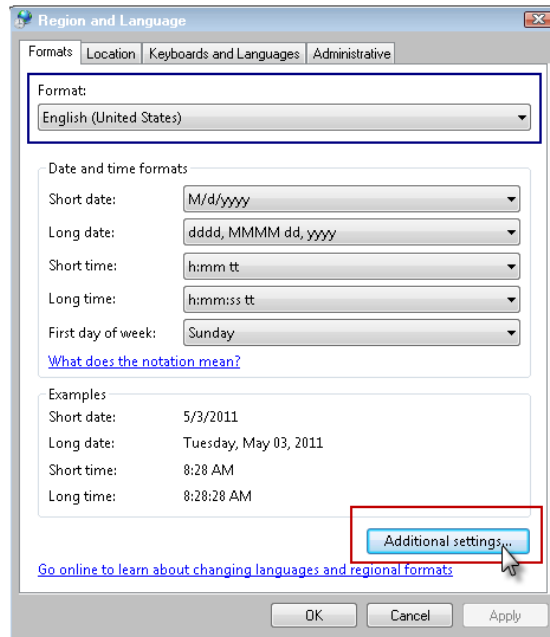

## 6 Administering System Functions and the Security Pack

### Pre-configurations for the 2100 Expert Software

- 5 In the **Customize Regional Options** window, click on the **Date** tab (see the green square) at the top of the window, then confirm that the **Short date** and **Long date** formats are as shown below. If either format is different than shown below, left-click on it and then select the correct format in the drop-down menu.

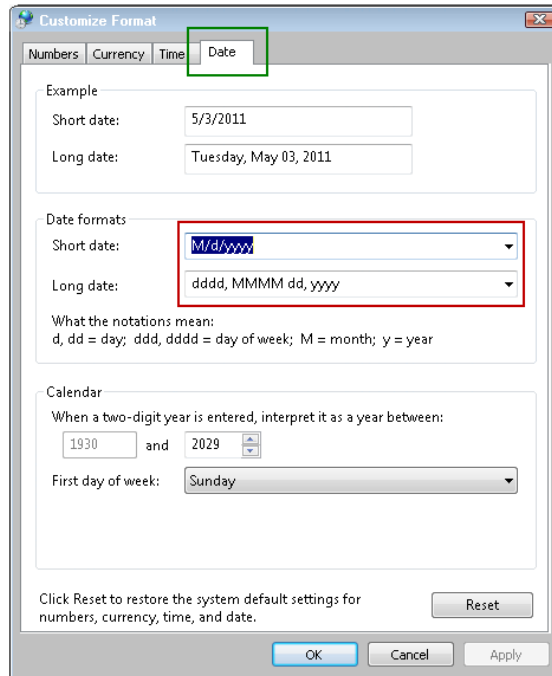

- 6 Click on **Apply** and then **OK** to save any changes. You can click on **OK** again to close down the window.

## Display settings

**The 2100 Expert Software does not support display resolution settings that exceed 2048 \* 1536 pixels. To prevent or resolve problems with your 2100 Expert Software, decrease the display resolution to below 1920 \* 1200 pixels:**

- 1 Windows 7: Right-click on your desktop and select **Display settings** from the menu. In the new windows determine a display resolution below 1900 \* 1200 pixels from the drop-down list. Confirm by pressing **OK**.

OR

Windows 10: Right-click on your desktop and select **Display settings** from the menu. In the new windows select **Advanced display settings** and determine a display resolution below 1900 \* 1200 pixels. Confirm by pressing **Apply**.

## USB-to-Serial adapter configuration

The 2100 Bioanalyzer instrument can be connected to a USB port of the PC by using the auxiliary USB-to-Serial adapter cable. The correct drivers for the Agilent USB adapter cable (black) are available on your 2100 Expert Software media. A previous version of the adapter cable (blue/silver) is not supported for Windows 7 or Windows 10. Moreover, other manufacturer's USB-to-serial adapter cables are not supported and should be exchanged with the standard Agilent USB adapter cable (black) that is delivered with each system.

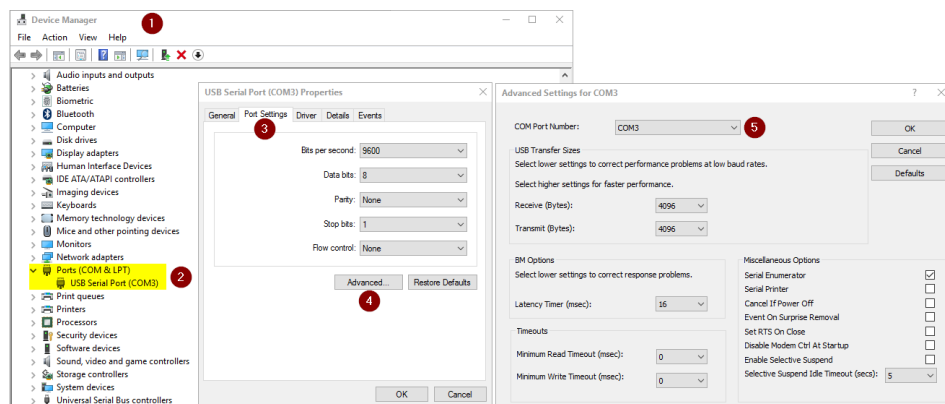

Once the adapter drivers are installed on the PC, a COM-port number will be assigned to the adapter. In case your PC has other physical COM-ports assigned, the available numbers become restricted. Double digit values for the 2100 Bioanalyzer USB-to-Serial adapter cable COM-port are not supported and need to be changed accordingly:

- 1 Open the device manager.
- 2 Navigate to the Ports section and right-click on the **USB Serial Port** to select **Properties**.
- 3 Select the **Port Settings** menu tab.
- 4 Open the **Advanced** settings by clicking the corresponding button.
- 5 Select an appropriate **COM-Port Number** with a single digit only. Confirm by pressing **OK**.

## Configuring the 2100 Expert Software

The available options for configuring the 2100 Expert Software can be found in the **System** context on the **System Wide Settings** tab.

### How to Configure the 2100 Expert Software

#### How to Specify Data File Names and Directories

The measurement results are stored automatically when the chip run is complete. To make it easier for you to identify the chip data files, you can configure an automatic naming scheme for the files.

However, due to the regulations of the FDA compliance, the names of the files and directories cannot be chosen freely. You can only specify a custom prefix that will be used for the file names.

To specify the names and destination for generated chip data files:

#### NOTE

The 2100 Expert Security Pack restricts access to data and functionality to users who are logged in with certain roles. See *User Role Model* ("[Access Control](#)" on page 39) for details.

---

- 1 Select **Data Files** in the tree navigation.

The **Data Files** screen becomes visible:

- 2 In the **Data File Name** section, select the check boxes of the strings you want to insert in the file names:

Option	Meaning
<b>Prefix</b>	Inserts an arbitrary string to identify the data file. This string can be modified. The default file prefix is "2100 expert".
<b>Assay Class</b>	Inserts the assay class in the file name. Examples: "DNA1000".
<b>Serial Number</b>	Inserts the serial number of the Agilent 2100 Bioanalyzer instrument used for the chip run.
<b>Date</b>	Inserts the date of the chip run.
<b>Time / Counter</b>	Inserts the time of the chip run/inserts an auto-incremented 3-digit number.



- 3 In the **Data File Directory** section, specify the **Default Directory** where the chip data files are to be stored. Use the **Browse** button to select a directory or click **Reset** if you want to use the ..\ > **Data** directory under the 2100 Expert Software installation directory.
- 4 Optionally, you can select the check box **Create Daily Subdirectories** if you want daily subdirectories to be created.

This option helps you to better organize your chip data files. If selected, a subdirectory is created for every day in which a chip run was started. The name of the subdirectory has the format "YYYY-MM-DD", for example, "2005-01-22". All chip data files generated on this day will be stored in this subdirectory.
- 5 In the Data File Format section, select whether you want to save the data files in **Binary Format** or in **XML Format**.
- 6 Use the **Prefix** field to specify a default prefix for the created files. This default prefix can be changed by every analyst in the **Instrument** context for each chip run.

### How to Set Run and Result Options

You can select several options such as to pause the analysis on setpoint changes, the maximum log file size, or the graph colors.

The 2100 Expert Security Pack restricts access to data and functionality to users who are logged in with certain roles. See User Role Model for details (“[Access Control](#)” on page 39).

To set the **Run and Result** options:

- 1 Select **Run and Result** in the tree navigation.

The **Run and Result** screen becomes visible:

The screenshot shows the configuration interface for the Run and Result options. It is organized into several sections:

- Advanced:** Contains two checkboxes, **Auto Run** and **Auto Print**, both of which are currently unchecked. To the right of these checkboxes is a button labeled **Settings...**.
- Analysis:** Contains one checkbox, **Pause Analysis on Setpoint Change**, which is currently unchecked.
- Graph Signal Color:** Displays 12 color swatches arranged in a 4x3 grid, labeled **Signal 1** through **Signal 12**. The colors are: Signal 1 (Blue), Signal 2 (Green), Signal 3 (Cyan), Signal 4 (Magenta), Signal 5 (Orange), Signal 6 (Black), Signal 7 (Lime Green), Signal 8 (Purple), Signal 9 (Light Blue), Signal 10 (Teal), Signal 11 (Brown), and Signal 12 (Yellow).
- Auto Lock Interval:** Contains a text input field with the label "Time until application gets locked, if no user interaction happens (in minutes):" and the value **10**.

- 2 In the **Advanced** section, you can
  - select **Auto Run** to activate the automatic start of a chip run once the lid of the Agilent 2100 Bioanalyzer instrument is closed and a chip suiting the selected assay is detected.
  - select **Auto Print** to enable the automatic report printing function.

You can now click **Settings** to display the **Autoprint** dialog box, where you set the options for automatic printing after a chip run is complete.

**NOTE**

The **Auto Print** settings are independent from those made via the **Print** command of the **File** menu.

- 3 In the **Analysis** section, you can activate the **Pause Analysis on Setpoint Change** function.

If this function is not active, the measurement results are recalculated every time after you change a setpoint. If you need to change several setpoints at once, activating this function saves you time, because the results are only recalculated when leaving the setpoint explorer or when starting the analysis manually with the start button.

- 4 In the **Graph Signal Color** section, click the colored rectangles to the right of the signals.

You can now choose a new color for the selected signal in the **Color** dialog box.

### To define auto export options:

The 2100 Expert Security Pack restricts access to data and functionality to users who are logged in with certain roles. See User Role Model for details (“[Access Control](#)” on page 39).

- 1 Switch to the **System** context and select the **System Wide Settings** tab.
- 2 Select **Auto Export** in the tree navigation.  
The **Auto Export** screen becomes visible:

## 6 Administering System Functions and the Security Pack

### Configuring the 2100 Expert Software

Auto Export

---

Electrophoresis Export

Result Tables  
Create a csv file containing result table values.

Exclude Markers

Include Ladders

Strip off Excluded Peaks

Sample Data  
Export textual list files, one file per sample.

Gel Image  
Export the gel image.

As one image  [Formats]

Each lane separately  [Formats]

Electropherogram Images  [Formats]  
Export the electropherogram of each sample as a separate file.

---

Flow Cytometry Export

Result Tables  
Create a csv file containing result table values.

Sample Data  
Export textual list files, one file per sample.

FCS Data  
Create FCS standard files, one file per sample.

Dot Plot Images  [Formats]  
Export the Dot Plot image, one file per sample.

Histogram Images  [Formats]  
Export the blue and red histogram images, one file per sample.

- 3 To export a datafile automatically after every chip run, activate the **Auto Export** check box.

- 4 Specify which elements are to be included in the exported file for electrophoresis measurements.
- 5 Select **Default Export Directories** in the tree navigation and define the default directories for the various file types. Optionally, you can activate the **Create daily subdirectories** check box to automatically export the files of each day to separate directories.
- 6 When leaving the **System** context, you are asked to confirm your changes with your electronic signature.

## How to Activate Software Licenses

By installing the 2100 Expert Software you have also installed a license administration tool. This tool is used to activate the different software modules. The following licenses are available:

- 2100 electrophoresis license
- 2100 Security Pack license
- 2100 instrument control license

To activate an additional software license:

- 1 Select **Help > Registration** to open the **License Administration Tool** window.

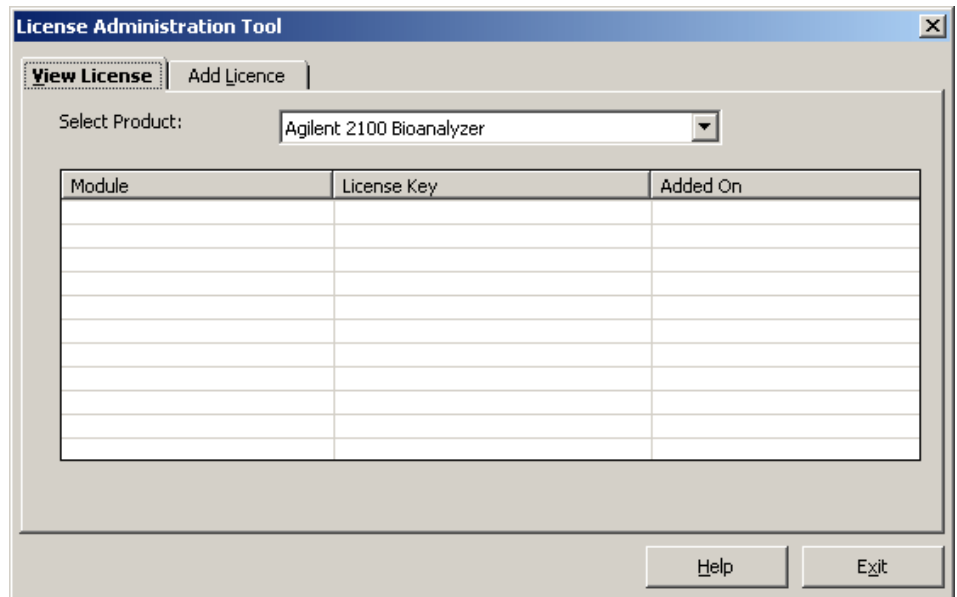

## 6 Administering System Functions and the Security Pack

### Configuring the 2100 Expert Software

- 2 Switch to the **Add License** tab.
- 3 In the **Select Product** field, the **Agilent 2100 Bioanalyzer** must be selected.
- 4 In the **Select Module** field, select the license for the software module that you want to activate.

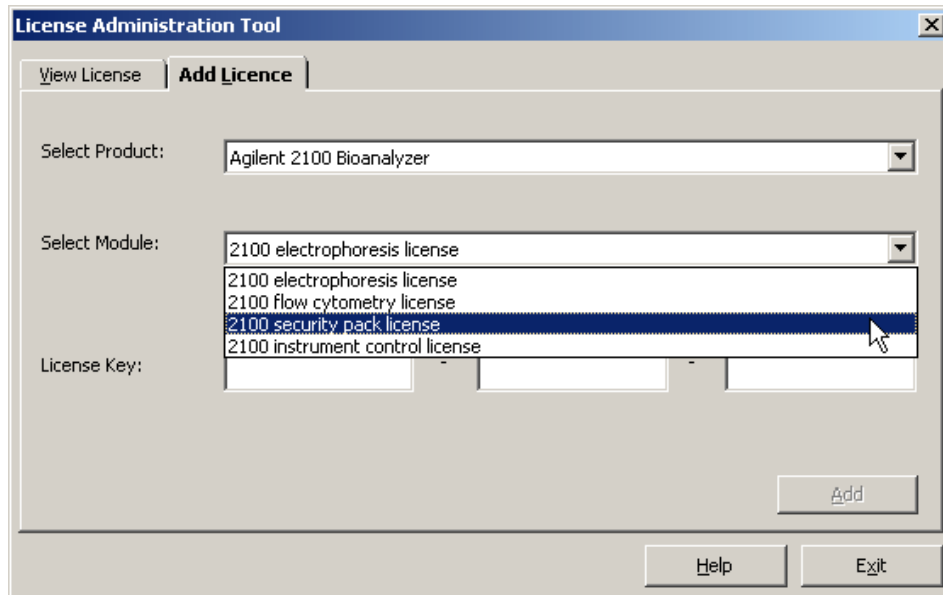

- 5 Enter the correct **License Key** and click **Add**.  
A message box informs you whether the license key was added successfully.
- 6 If you want to add more licenses, repeat the previous two steps for every license key.
- 7 To close the **License Administration Tool** window, click **Exit**.

The licensed software modules are now activated and can be used.

#### NOTE

If you added the license key to activate the security pack, the 2100 Expert Software closes and the secured file area will be set up. Follow the instructions displayed in the different pages of the setup wizard.

#### NOTE

Store your license keys in a secure place and make sure you do not lose them.

## Exporting and Importing Multiple Data Files

### NOTE

The 2100 Expert Security Pack restricts access to data and functionality to users who are logged in with certain roles. See *User Role Model* (“[Access Control](#)” on page 39) for details.

---

2100 Expert Software allows to export and import multiple data files at once. With this functionality, you produce *copies* of these files outside the secured area, for example, to use them for presentations or analysis with external tools.

### NOTE

This behavior is in contrast to the archiving functionality, which *moves* the files to a distinct destination. Exporting does not remove any files from their original location.

Files that are marked to be read-only will not be archived.

---

### To export multiple 2100 Expert data files:

- 1 Switch to the **System** context and go to the **Import - Export** tab.  
On the left side of this tab, you can see the structure of the **Secured Area** of the 2100 Expert Software. On the right side you see the structure of the currently selected import directory.
- 2 If you want to export data to a different directory, click the Browse button and select the correct directory.
- 3 Activate the **Export** radio button.
- 4 In the structure of the Secured Area, navigate to the folder or file to be exported (open folders by double-clicking them) and click the >>> button.  
The selected folder or file is added to the structure in the selected export directory.
- 5 If you need to export more folders or files, repeat this step for all remaining data to be exported.
- 6 If you want the files to be exported including their original path, activate the **Include Path** checkbox.
- 7 To start the actual exporting procedure, click the **Export** button.  
The signature dialog opens and lists all files that are selected to be exported.

After the exporting procedure is finished, you can click the **Report** button to see, whether all files have been successfully exported or not. This information is also written to the system log file.

The files that are exported can now be normally accessed with external tools without any restrictions.

#### To import multiple 2100 Expert data files:

- 1 Switch to the **System** context and go to the **Import - Export** tab.

On the left side of this tab, you can see the structure of the **Secured Area** of the 2100 Expert Software. On the right side you see the structure of the currently selected import directory.

- 2 If you want to import data from a different directory, click the **Browse** button and select the correct directory.
- 3 Activate the **Import** radio button.
- 4 In the structure of the import directory, navigate to the folder or file to be imported (open folders by double-clicking them) and click the <<< button.  
The selected folder or file is added to the list below the **Secured Area**.
- 5 If you need to import more folders or files, repeat this step for all remaining data to be imported.
- 6 Click the **Import** button to start the actual importing procedure.

The signature dialog opens and lists all files that are selected to be imported.

After the importing procedure is finished, you can click the **Report** button to see, whether all files have been successfully imported or not. This information is also written to the system log file.

The files that are imported to the **Secured Area** can now be normally accessed with 2100 Expert Software.



## Archiving Data

### NOTE

The 2100 Expert Security Pack restricts access to data and functionality to users who are logged in with certain roles. See *User Role Model* ( “Access Control” on page 39) for details.

---

It is recommended that you regularly archive data to preserve systemspace and to alleviate file handling and file search. 2100 Expert Software will not allow deleting electronic records, but will allow you to remove files after successfully completed archiving operations.

Users that have the roles 2100 administrator and backup operator have the necessary read (for performing a backup) and write (for restoring) permissions in the secured area. Thus, they are able to both do regular copies and to apply functionality of an external backup system to that part of the file system occupied by the secured area.

2100 Expert Software does not provide any other backup functionality besides the read and write permissions for backup operator and 2100 administrator.

### To archive 2100 Expert data files:

- 1 Switch to the **System** context and go to the **Archiving** tab.  
On the left side of this tab, you can see the structure of the **Secured Area** of the 2100 Expert Software. On the right side you see the structure of the currently selected archiving directory.
- 2 To archive data to a different directory , click the **Browse** button and select the correct directory.

### NOTE

It is recommended to archive the data to the archive folder of the secured area.

---

- 3 Activate the **Archiving** radio button.

- 4 In the structure of the **Secured Area**, navigate to the folder or file to be archived (open folders by double-clicking them) and click the >>> button.  
The selected folder or file is added to the tree structure in the archiving directory.
- 5 If you need to archive more folders or files, repeat this step for all remaining directories to be archived.
- 6 To start the actual archiving procedure, click the **Archive** button.  
The signature dialog opens and lists all files that are selected to be archived.
- 7 Confirm this action with your electronic signature.

After the archiving procedure is finished, a message box opens, informing you about whether all files have been archived successfully or not. This information is also written to the system log file.

The files that are moved to the archiving directory can now be processed with external archiving tools or mechanisms.

#### To de-archive 2100 Expert data files:

- 1 Switch to the **System** context and go to the **Archiving** tab.  
On the left side of this tab, you can see the structure of the **Secured Area** of the 2100 Exert Software. On the right side you see the structure of the currently selected archiving directory
- 2 If you want to de-archive data from a different archiving directory, for example, from a CD drive, click the **Browse** button and select the correct directory.
- 3 Activate the **De-archive** radio button.
- 4 Click the <<< button.  
The secured area directories and file structure follows an inherent rule. So a file carries all information to locate it into it's correct location automatically.
- 5 If you need to de-archive more directories, repeat the previous step for all remaining directories to be de-archived.
- 6 To start the actual de-archiving procedure, click the **De-archive** button.

## How to Generate Archiving Reports

After you have archived and/or de-archived data files, it is recommended to generate and save a report to document your work.

To generate an archiving report:

- 1 Click the **Report** button.

The **Report** dialog box opens.

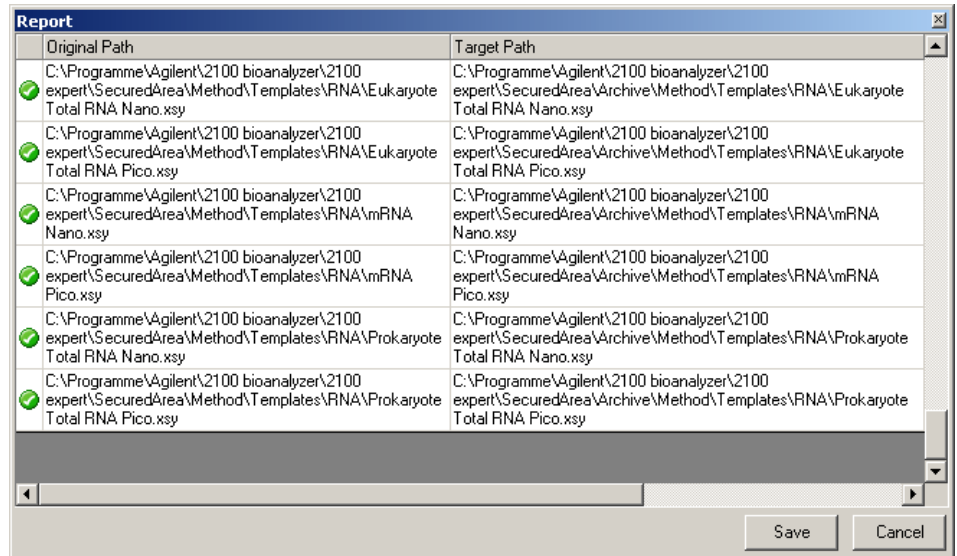

- 2 Save the report by clicking the **Save** button. Then select a file name and destination to save the report as .TXT file.

## Using Log Books

2100 Expert Software provides several log books to document all relevant actions and changes. Due to requirements of data integrity and data security, none of the log books can be cleared.

### Run Logs

The run log books can be found in the following contexts as sub-tabs of the **Log Book** tab:

- **Data** context
- **Verification** context
- **Comparison** context
- **Method** context

They contain events such as the start and end time of a chip run, and any errors or problems that occurred during the run.

General Properties   Assay Properties   Chip Summary   Gel   Electropherogram   Result Flagging   Log Book							
	Description	Number	Source	Category	Sub Category	Time Stamp /	
▶	Demo Run Started (File: C:\Programme\Agilent\2100 bioanalyzer\2100 expert\SecuredArea\Data\dsDNA\DNA_7500\demo DNA_7500\2100		Instrument	Run		Apr-27-2005 09:34:57	
▶	Demo Run ended (Number of wells acquired: 13)		Instrument	Run		Apr-27-2005 09:36:49	

All run logs are saved in the data files within the respective context.

### Signature Logs

The signature log books can be found as sub-tabs in the following contexts:

- **Data** context on the **Log Book** tab
- **Verification** context on the **Log Book** tab
- **Comparison** context on the **Comparison Log Book** tab
- **Method** context on the **Log Book** tab
- **System** context on the **System Log Book** tab

They contain all actions that have been performed and confirmed with electronic signatures.

General Properties	Assay Properties	Chip Summary	Gel	Electropherogram	Result Flagging	Log Book	
	Timestamp / Time Zone	User Name	Role	Meaning	Comment	Version	
	Apr-27-2005 09:34:55 (GMT +02:00)	Mr. Advanced	Advanced Operator	Started Chip Run		1	
	Apr-27-2005 09:39:37 (GMT +02:00)	Mr. Advanced	Advanced Operator	Altered Analysis Set Points		2	
	Apr-27-2005 09:41:12 (GMT +02:00)	Mr. Advanced	Advanced Operator	Altered Analysis Set Points		3	
	Apr-27-2005 09:48:25 (GMT +02:00)	Mr. Advanced	Advanced Operator	Altered Analysis Set Points		4	
	Apr-27-2005 10:01:02 (GMT +02:00)	Mr. Advanced	Advanced Operator	Altered Analysis Set Points		5	
	Apr-27-2005 10:47:10 (GMT +02:00)	Mr. Advanced	Advanced Operator	Altered Analysis Set Points		6	
	Apr-27-2005 10:51:35 (GMT +02:00)	Mr. Advanced	Advanced Operator	Altered Analysis Set Points		7	
	Apr-27-2005 10:54:34 (GMT +02:00)	Mr. Advanced	Advanced Operator	Altered Analysis Set Points		8	
	Apr-27-2005 12:55:15 (GMT +02:00)	2100 Administrator	2100 Administrator	Archived file	Altered Analysis Set Points	9	
	Apr-27-2005 13:30:37 (GMT +02:00)	2100 Administrator	2100 Administrator	Restored file	Altered Analysis Set Points	10	

All signature logs are saved in the data files within the respective context.

## Audit Trails

The audit trails can be found as sub-tabs in the following contexts:

- **Data** context on the **Log Book** tab
- **Verification** context on the **Log Book** tab
- **Comparison** context on the **Log Book** tab
- **Method** context on the **Log Book** tab
- **System** context on the **System Log Book** tab

They contain all actions that have been performed and confirmed with electronic signatures. While the signature logs only contain one entry per entered signature, the audit trails list all actions in detail.

## 6 Administering System Functions and the Security Pack Using Log Books

General Properties											
Assay Properties			Chip Summary		Gel	Electropherogram		Result Flagging		Log Book	
Description	Timestamp	Time Zone	User Name	Setpoint	Operation	Old Value	New Value	Version	Meaning	Sample	
+ Started Chip Run											
+ Modified file for Restored file											
+ Modified file for Archived file											
+ Applied result flagging rule											
+ Altered Chip Summary											
+ Altered Analysis Set Points											
+ Smear Region modified											
- Smear Region added											
Smear Region added	Apr-27-2005 09:56:01	(GMT +02:00)	Mr. Advanced	Region Color	Modified	0	10465547	5	Altered Analysis Set Points	PCR IV	
Smear Region added	Apr-27-2005 09:56:01	(GMT +02:00)	Mr. Advanced	Region end size	Modified	0	405.2018	5	Altered Analysis Set Points	PCR IV	
Smear Region added	Apr-27-2005 09:56:01	(GMT +02:00)	Mr. Advanced	Region start	Modified	0	287.724	5	Altered Analysis Set Points	PCR IV	
Smear Region added	Apr-27-2005 09:56:01	(GMT +02:00)	Mr. Advanced	Region ID	Modified	-1	2	5	Altered Analysis Set Points	PCR IV	
Smear Region added	Apr-27-2005 09:56:01	(GMT +02:00)	Mr. Advanced	Regions	Item added in collection			5	Altered Analysis Set Points	PCR IV	
Smear Region added	Apr-27-2005 09:53:55	(GMT +02:00)	Mr. Advanced	Region Color	Modified	0	2921.797	5	Altered Analysis Set Points	PCR IV	
Smear Region added	Apr-27-2005 09:53:55	(GMT +02:00)	Mr. Advanced	Region end size	Modified	0	517.8918	5	Altered Analysis Set Points	PCR IV	
Smear Region added	Apr-27-2005 09:53:55	(GMT +02:00)	Mr. Advanced	Region start	Modified	0	392.419	5	Altered Analysis Set Points	PCR IV	
Smear Region added	Apr-27-2005 09:53:55	(GMT +02:00)	Mr. Advanced	Region ID	Modified	-1	1	5	Altered Analysis Set Points	PCR IV	
Smear Region added	Apr-27-2005 09:53:55	(GMT +02:00)	Mr. Advanced	Regions	Item added in collection			5	Altered Analysis Set Points	PCR IV	
+ Altered Analysis Set Points											
+ Altered Chip Summary											
Run Log   Signature Log   Audit Trail											

All audit trails are saved in the data files within the respective context.

## System Log

The system log book can be found in the **System** context under the **System Log Book** tab.

It includes start-up and shut-down events of the 2100 Expert Software, and, for example, errors or problems with the connected 2100 Bioanalyzer instruments.

Users and Roles   System Wide Settings   Archiving   Import - Export   System Log Book							
	Description	Number	Source	Category	Sub Category	Time Stamp	
	File has been modified: C:\Programme\Agilent\2100 bioanalyzer\2100 expert\SecuredArea\System\SystemFile.xml	3	Security Service	System		Apr-26-2005 08:10:42	
	File has been modified: C:\Programme\Agilent\2100 bioanalyzer\2100 expert\SecuredArea\System\SystemFile.xml	3	Security Service	System		Apr-26-2005 08:10:40	
	User switched, new user is PC_MM_SK\advvaoper and old user was PC_MM_SK\2100admin	0	User Interface			Apr-26-2005 08:10:20	
	File has been modified: C:\Programme\Agilent\2100 bioanalyzer\2100 expert\SecuredAreaMethod\Templates\RNA\Eukaryote Total RNA Nano.xsy	3	Security Service	System		Apr-26-2005 08:09:12	
	File has been modified: C:\Programme\Agilent\2100 bioanalyzer\2100 expert\SecuredArea\Archive	3	Security Service	System		Apr-26-2005 08:09:12	
	File has been modified: C:\Programme\Agilent\2100 bioanalyzer\2100 expert\SecuredArea\Archive	3	Security Service	System		Apr-26-2005 08:09:11	
	File has been modified: C:\Programme\Agilent\2100 bioanalyzer\2100 expert\SecuredArea\Archive	3	Security Service	System		Apr-26-2005 08:09:10	
	File has been modified: C:\Programme\Agilent\2100 bioanalyzer\2100 expert\SecuredArea\System\SystemFile.xml	3	Security Service	System		Apr-26-2005 08:09:07	
	File has been modified: C:\Programme\Agilent\2100 bioanalyzer\2100 expert\SecuredArea\System\SystemFile.xml	3	Security Service	System		Apr-26-2005 08:09:06	
	File has been modified: C:\Programme\Agilent\2100 bioanalyzer\2100 expert\SecuredAreaMethod\Demo Templates\dsDNA\Demo DNA 7500.xsy	3	Security Service	System		Apr-26-2005 07:53:50	
	2100 Administrator as 2100 Administrator has started 2100 expert (Version: B.02.01.SI209)	0	User Interface			Apr-26-2005 07:53:18	
	File has been modified: C:\Programme\Agilent\2100 bioanalyzer\2100 expert\SecuredArea\System\SystemFileLogs.xml	3	Security Service	System		Apr-26-2005 07:53:18	
	File has been modified: C:\Programme\Agilent\2100 bioanalyzer\2100 expert\SecuredArea\System\SystemFileLogs.xml	3	Security Service	System		Apr-26-2005 07:53:17	
	2100 expert security service started	0	Security Service	System		Apr-26-2005 06:34:16	
	Security Guard has been started to watch C:\Programme\Agilent\2100 bioanalyzer\2100 expert\SecuredArea	0	Security Service	System		Apr-26-2005 06:34:16	
	2100 expert ended (Version: B.02.01.SI209)	0	User Interface			Apr-25-2005 12:45:45	
	2100 Administrator as 2100 Administrator has successfully unlocked the application.	0	User Interface			Apr-25-2005 12:45:40	
	2100 Administrator as 2100 Administrator has started 2100 expert (Version: B.02.01.SI209)	0	User Interface			Apr-25-2005 11:02:26	

The system log book is saved in config/SystemFile.xml. The log book entries can be exported from this file.

The system log book is saved in SecuredArea/System/SystemLogs.xml. This file can be exported by the 2100 administrators and the backup operators. Additionally, this log book will be split up automatically when a certain file size is reached and saved as SystemLogs\_dddTttt.xml, where *ddd* and *ttt* are the current date and time. These files can be accessed via the operating system or opened in the 2100 Expert Software.

## How to change the display of the logbooks

### NOTE

The 2100 Expert Security Pack restricts access to data and functionality to users who are logged in with certain roles. See *User Role Model* (“[Access Control](#)” on page 39) for details.

---

### To deal with logbook table

#### To sort a log book table:

- 1 Click the column header you want to sort the table by.  
The log book table is sorted by the entries in the selected column in ascending order.
- 2 Click the column header again to reverse the order.

#### To filter a log book table:

- 1 In the **Log Book** toolbar, click **Filter** .  
The **Filter** dialog box appears.
- 2 To define a filter for events from a specified period of time, specify a **Start Time** and an **End Time**.
- 3 To define a filter for events with certain entries in a column, specify the column name and the value to search for.
- 4 Use the **Filter Action** radio buttons to define whether only events that match the filter criteria are displayed (**Appropriate events only**) or whether those events are highlighted that do not match the filter criteria while the others are still listed (**Mark inappropriate events**).



- To apply the filter to the log book table, click **OK**.

The filter definition in the following example excludes all events from the **Run Log** in the **Data** context with an **Event Type** other than **Critical**.

### To remove the filter from a log book table

- In the **Log Book** toolbar, click  for reset.

#### NOTE

You can hide/show any of the log table columns, and re-sort the columns by right-clicking the table and selecting **Columns** from the context menu.

## How to Search the Log Book

You can search the various log books for any string.

To search the **Log Book**:

### NOTE

The 2100 Expert Security Pack restricts access to data and functionality to users who are logged in with certain roles. See *User Role Model* (“[Access Control](#)” on page 39) for details.

- 1 In the **Log Book** toolbar, click **Find** .
- The **Find** dialog box appears.
- 2 Enter a search string in the **Find What** field.
- 3 Use the **Column** selection list to specify whether you want to search all columns or a particular column only.
- 4 Select the search **Direction**.

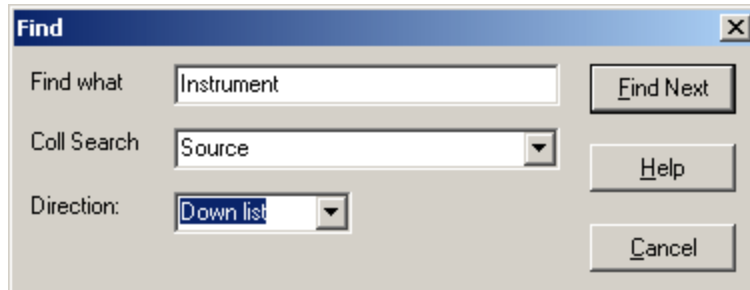

- 5 Click **Find Next**.  
If the search string was found in an event, the event row gets highlighted in yellow.

### NOTE

The search is case-sensitive!

- 6 To continue the search, click **Find Next**.

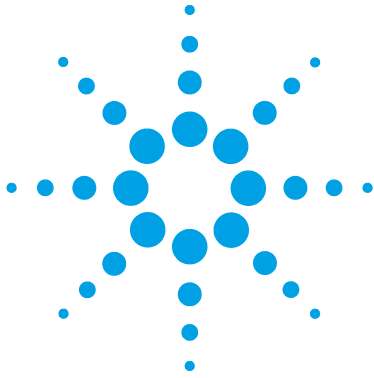

## 7 Running Instrument Diagnostics

Running Instrument Diagnostics [228](#)

How to Run Instrument Diagnostics Test [230](#)

This chapter shows how to use the diagnostic tests to check the 2100 Bioanalyzer instrument for proper functioning.



## Running Instrument Diagnostics

2100 Expert Software provides several tests to check proper functioning of the 2100 Bioanalyzer instrument. You should perform the tests on a regular basis, or if incorrect measurements occur.

**NOTE**

The 2100 Expert Software Security Pack restricts access to data and functionality to users who are logged in with certain roles. See *User Role Model* ( [“Access Control”](#) on page 39) for details.

### Generic 2100 Bioanalyzer Hardware Tests

<b>Diagnostics Test</b>	<b>Purpose</b>
<i>Electronics Test</i>	Verifies proper functioning of all electronic boards in the 2100 Bioanalyzer instrument.
<i>Fan Test</i>	Checks if the fan is running at the appropriate speed.
<i>Lid Sensor Test</i>	Verifies proper operation of the lid sensor, ensuring that the laser and LED are off when the lid is open.
<i>Stepper Motor Test</i>	Checks for proper movement of the stepper motor.
<i>Temperature Test</i>	Checks if the temperature ramp-up speed of the heater plate is within specifications.

## Electrode Cartridge Tests

Diagnosics Test	Purpose
<i>HV Stability and Accuracy Test</i>	Tests high voltage accuracy and stability of all 16 high voltage power supplies and the high voltage controller. Unused chip (DNA, RNA, or protein) required.
<i>HV Accuracy Test (On-Load)</i>	Check of channel-reference diode in transmission direction (Only available for G2939A and G2938C instruments.).
<i>Short Circuit Test</i>	Checks for instrument leak currents using an empty chip. Note: the limits of this test specify an ambient temperature of 25 °C and relative humidity less than or equal to 50 %. Higher temperatures or relative humidity could result in a leak current.
<i>Electrode/Diode Test</i>	Checks the photo diode and current-versus-voltage performance of the 2100 Bioanalyzer instrument. Electrode/diode test chip required.
<i>Optics Test</i>	Checks for proper alignment of internal optics and proper function of the laser and LED.
<i>Electrophoresis Autofocus Test</i>	Checks the focusing capability of the optical system. Autofocus test chip required.
<i>Laser Stability Test</i>	Measurement of stability of red laser signal.

## Test Chips

Test chips are required for the following tests and are included in the 2100 Bioanalyzer system (G2939BA).

*Test Chip Kit for Electrophoresis Methods (reorder no. G2938-68100)*

Test Chip	Comment	Quantity
Autofocus Test Chip	Values for fluorescence and offset are printed on the chip. Can be used multiple times.	1
Electrode/Diode Test Chip	Can be used multiple times.	1

## How to Run Instrument Diagnostics Test

### NOTE

Diagnostics tests cannot be run while the 2100 Expert Software is performing a chip run.

### NOTE

The 2100 Expert Security Pack restricts access to data and functionality to users who are logged in with certain roles. See *User Role Model* ( “Access Control” on page 39) for details.

- 1 Switch to the **Instrument** context.
- 2 In the **Tree View Panel**, select the 2100 Bioanalyzer instrument on which you want to run the tests.
- 3 Switch to the **Diagnostics** tab.
- 4 Select the tests you want to run:
  - Select the **Apply** check boxes to select single tests.
  - Click **Select All** to select all available tests.
  - Click **Unselect All** to deselect all tests.

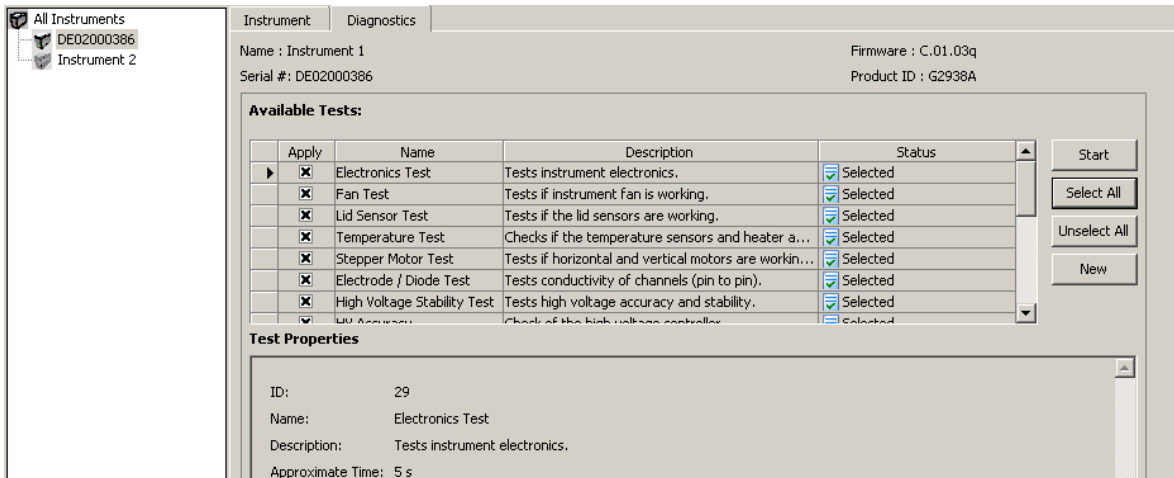

Apply	Name	Description	Status
<input checked="" type="checkbox"/>	Electronics Test	Tests instrument electronics.	Selected
<input checked="" type="checkbox"/>	Fan Test	Tests if instrument fan is working.	Selected
<input checked="" type="checkbox"/>	Lid Sensor Test	Tests if the lid sensors are working.	Selected
<input checked="" type="checkbox"/>	Temperature Test	Checks if the temperature sensors and heater a...	Selected
<input checked="" type="checkbox"/>	Stepper Motor Test	Tests if horizontal and vertical motors are workin...	Selected
<input checked="" type="checkbox"/>	Electrode / Diode Test	Tests conductivity of channels (pin to pin).	Selected
<input checked="" type="checkbox"/>	High Voltage Stability Test	Tests high voltage accuracy and stability.	Selected

**Test Properties**

ID: 29  
Name: Electronics Test  
Description: Tests instrument electronics.  
Approximate Time: 5 s

- 5 Click **Start**.

You need to confirm this action with your electronic signature.

- Follow the instructions given by the 2100 Expert Software. For example to put in a test chip in the receptacle of the 2100 Bioanalyzer instrument when requested by the software.

The **Status** column indicates the status of each test:

- **Executing**
- **Execution pending**
- **Executed, passed**
- **Executed, failed**

The screenshot shows the 'Diagnostics' window for 'Instrument 1'. The 'Available Tests' table is as follows:

Apply	Name	Description	Status
<input checked="" type="checkbox"/>	Electronics Test	Tests instrument electronics.	Executed, passed
<input checked="" type="checkbox"/>	Fan Test	Tests if instrument fan is working.	Executed, passed
<input checked="" type="checkbox"/>	Lid Sensor Test	Tests if the lid sensors are working.	Executed, passed
<input checked="" type="checkbox"/>	Temperature Test	Checks if the temperature sensors and heater a...	Executing
<input checked="" type="checkbox"/>	Stepper Motor Test	Tests if horizontal and vertical motors are workin...	Execution pending
<input checked="" type="checkbox"/>	Electrode / Diode Test	Tests conductivity of channels (pin to pin).	Execution pending
<input checked="" type="checkbox"/>	High Voltage Stability Test	Tests high voltage accuracy and stability.	Execution pending
<input checked="" type="checkbox"/>	UV Accuracy	Check of the high voltage controller	Execution pending

The 'Bioanalyzer hardware test' dialog box contains the following text:

Please insert Cartridge and an empty chip!  
Close the lid and press OK.

The 'Test Properties' section for the 'Temperature Test' shows:

- ID: 4
- Name: Temperature Test
- Description: Checks if the temperature sensors
- Approximate Time: 360 s

The 'Limits' section shows:

- Heater test destination Temperature : 40 °C
- Heater Ramp Timeout : 300 s
- Duration of stability test : 45 s
- Required Temperature Stability : 0.4 °C

The 'Requirements' section is currently empty.

All selected tests are performed.

## **7** Running Instrument Diagnostics

### How to Run Instrument Diagnostics Test

- 7** If any test failed, redo the test.
- 8** If failures still persist, contact Agilent service.

The results of diagnostics tests are stored in .xdy files in the 2100 Expert Installation folder under “..\diagnosis”. If tests fail, send the .xdy files to the Agilent service.





## 8 Performing Verifications

Performing Verifications 234

Verifications 235

This chapter describes how you can validate your 2100 Bioanalyzer system.



## Performing Verifications

To ensure a validated Agilent 2100 Bioanalyzer system, verification steps have to be performed at installation and operation level. 2100 Expert Software allows for detailed *installation verification* and *system verification* on both the 2100 Bioanalyzer system hardware and software. Each verification comprises a series of tests and measurements that you can run and document in the **Verification** context of the 2100 Expert Software.

### NOTE

The 2100 Expert Security Pack restricts access to data and functionality to users who are logged in with certain roles. See *User Role Model* ( [“Access Control”](#) on page 39) for details.

---

# Verifications

## Installation Verification

Installation verification includes tests to verify that the 2100 Bioanalyzer system is installed properly and that all electrical connections are correct.

Installation verification must be performed once after installation.

## System Verification

System verification proves that the 2100 Bioanalyzer system will function according to its operational specifications in the selected environment.

System verification should be performed:

- at first use of the instrument,
- after relocating the instrument,
- after changing essential parts of the system, for example software updates or exchange of cartridges,
- after instrument repair,
- on regular time intervals.

## To perform verification tests:

- 1 Switch to the **Verification** context.
- 2 From the **File** menu select **New**.

A **New Verification** item appears in the **Tree View Panel**. Now it is possible to choose in the **Tree View Panel** from the possible actions: **Installation Verification** for hardware and software **System Verification** for hardware and software

### NOTE

If you plan to perform a hardware verification please make sure that the correct instrument and cartridge is selected (displayed in the Configuration Tab)

## 8 Performing Verifications

### Verifications

- Under **Cartridge Details**, click **Select** and specify details on the cartridge that is currently installed in the 2100 Bioanalyzer instrument. Use the free-text **Identifier** field to specify cartridge details.
- Under **Configure 2100 Bioanalyzer HW Test Chips**, enter the test chips you will use for this hardware verification (not required if performing software verification only):

	Test Chip Type	Lot Number	Offset	Intensity	
1	Autofocus Test Chip	F07CTF	270	410	
2	Electrode/Diode Test Chip	F23CTE			
3	Cell Autofocus Test Chip	EA09E			

#### NOTE

To execute hardware tests the 2100 Bioanalyzer instrument must be properly connected and switched on.

- 5 In the **Tree View Panel**, navigate to the test category you want to execute. Select the category via **Installation/System Verification – Software/Hardware**. The **Configuration** tab now lets you select verification tests to be executed in the verification run:

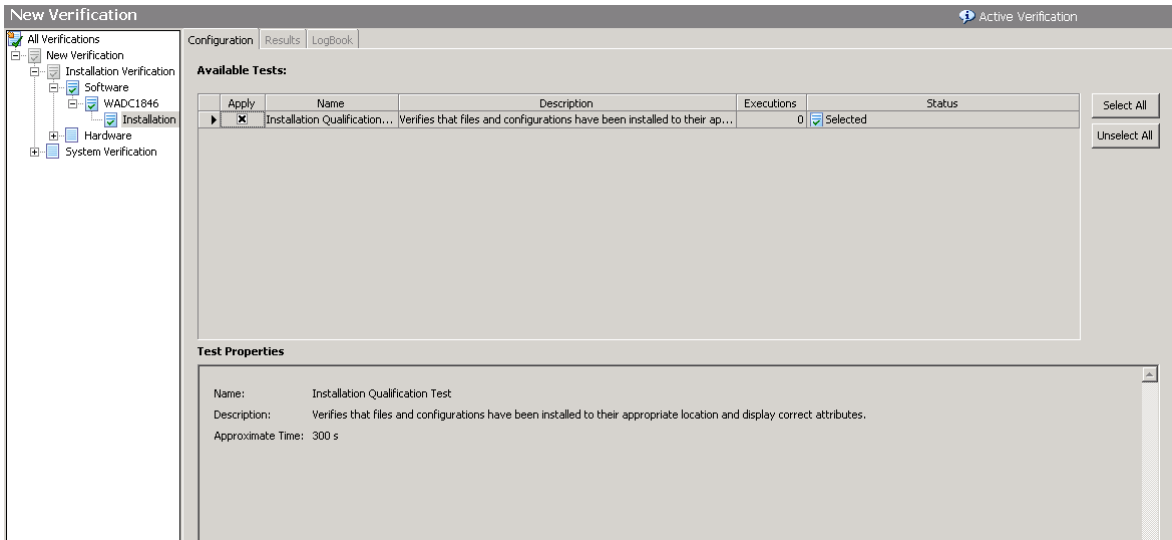

To select tests, check the **Apply** check box next to the test(s).

- 6 To start the selected tests, click  **Start** button in the toolbar. The **Save As** dialog box appears. You need to confirm this action with your electronic signature.

## 8 Performing Verifications

### Verifications

- 7 Specify a name and location for the verification results file (.xvd) and click **Save**.

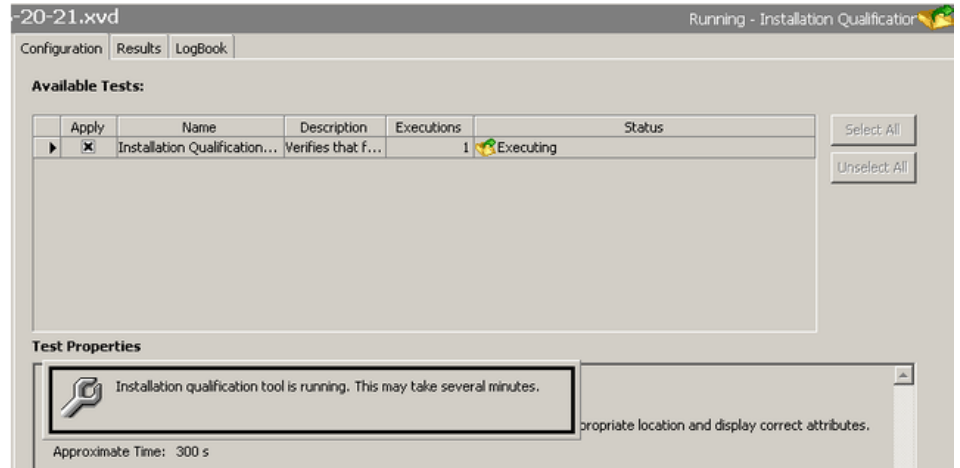

The selected tests are executed.

- 8 If a test fails, you can **Repeat** test execution, **Abort** the verification run, or skip the current test and **Continue** with the next test:

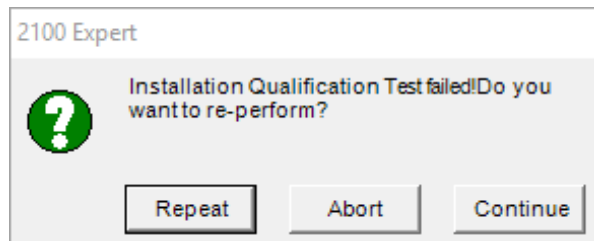

After all tests have been executed the following message appears:

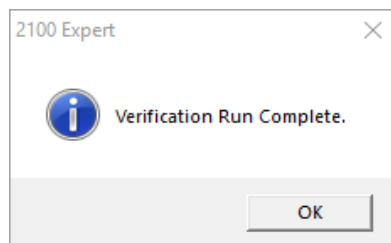

9 Click **OK**.

The **Status** column shows which of the tests have been run successfully, which have failed, and which have mixed results with multiple executions.

Executions	Status
1	✔ Executed, passed
1	✔ Executed, passed
2	⚠ Executed, mixed results after multiple executi... ▼
1	✔ Executed, passed
1	✔ Executed, passed
1	✔ Executed, passed
1	✔ Executed, passed
1	✔ Executed, passed
1	✔ Executed, passed
2	✘ Executed, failed after multiple executions
1	✔ Executed, passed
1	✔ Executed, passed

**10** To view details on test execution, select the **Results** tab.

The screenshot displays a software interface with three tabs: 'Configuration', 'Results', and 'LogBook'. The 'Results' tab is active, showing a table with the following data:

Execution #	Date and Time	Status	Comment
1	27.04.2005 16:20:25	Failed	failed (results beyond limits)

Below the table, the test details are shown:

Name: Installation Qualification Test  
Description: Verifies that files and configurations have been installed to their appropriate location and display correct attributes.  
Approximate Time: 300 s  
Test Status: **Executed, failed**

The 'IQ/SW results' section contains the following text:

Installation Qualification of Agilent 2100 Bioanalyzer System Software - 2100 expert Version (27.04.2005 16:20:28)  
Check of application directory structure ...  
Passed C:\Programme\Agilent\2100 bioanalyzer\2100 expert\help  
Passed C:\Programme\Agilent\2100 bioanalyzer\2100 expert\configuration\validation OQ\electrophoresis  
Passed C:\Programme\Agilent\2100 bioanalyzer\2100 expert\reports\templates  
Passed C:\Programme\Agilent\2100 bioanalyzer\2100 expert\reports  
Passed C:\Programme\Agilent\2100 bioanalyzer\2100 expert\assays  
Passed C:\Programme\Agilent\2100 bioanalyzer\2100 expert\data\packets  
Passed C:\Programme\Agilent\2100 bioanalyzer\2100 expert\assays\demo\flow cytometry

**11** You can now navigate to other test categories and execute additional verification tests.



**12** When you close the verification result file (**File > Close**), try to switch to another context, or exit 2100 Expert Software, the following message appears:

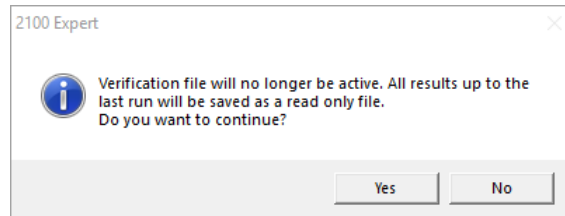

If you select **No**, you return to the **Verification** context and can run further verification tests.

If you select **Yes**, the verification result file (.xvd) is closed and becomes read-only.

**NOTE**

You can re-open verification result files only for viewing and printing.

**HINT**

Select **File > Print** to generate a printed report of the verification run.

## **8 Performing Verifications**

### **Verifications**

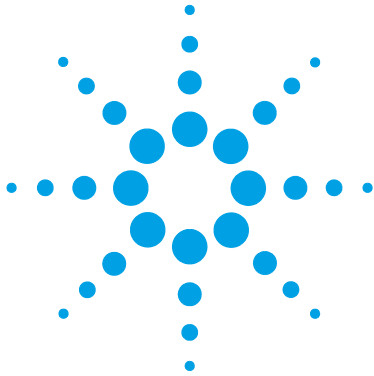

## 9 Products, Spare Parts, and Accessories

Products, Spare Parts, and Accessories 244

This chapter lists all parts and accessories—including reorder numbers.



## Products, Spare Parts, and Accessories

To buy the following products, spare parts and accessories for the Agilent 2100 Bioanalyzer system, please refer to our webpage:

<http://www.genomics.agilent.com/en/>

- **G2939BA** – Agilent 2100 Bioanalyzer System  
Includes 2100 Bioanalyzer instrument, Start-up Service, Electrode Cartridge, 2100 Expert Software on CD-ROM and software license, accessories, IKA Vortex Mixer.
- **G2953CA** – Agilent 2100 Bioanalyzer System Upgrade Laptop  
Includes HP laptop PC

### Software and Services

- **G2946CA** – Agilent 2100 Expert Software Upgrade  
Software package for upgrade to the latest 2100 Expert Software and licence.
- **G2949CA** – Agilent 2100 Expert Security Pack  
Includes Security Pack software license for the 2100 Expert Software and Start-up Service.

Additional services for Installation Qualification (IQ) and Operation Qualification/Performance Verification (OQ/PV) and Operational Services are available and can be ordered separately.

## Spare Parts and Accessories

- **2110-0007** - Fuse
- **5042-1398** - Adjustable Clip for use as spare part for the chip priming station
- **5065-4401** - Chip Priming Station including gasket kit and adjustable clip
- **5065-4413** - 16-pin bayonet Electrode Cartridge
- **5065-9951** - Electrode Cleaner Box, contains 7 electrode cleaners
- **5067-1589** - IKA Vortex mixer, must be ordered at IKA (<http://www.ika.de>)
- **5067-1599** - IKA Vortex Mixer Adapter
- **8121-1013** - USB-Serial Adapter Cable
- **G2938-68100** -Test Chip Kit for Electrophoretic Methods, includes 1 Autofocus, and 1 Electrode/Diode test chip
- **G2938-68716** - Gasket Kit, includes spare parts for the chip priming station: 1 plastic adapter, 1 ring and 10 gaskets
- **G2938-81605** - RS 232 cable, (communication cable PC – Agilent 2100 Bioanalyzer instrument)

## Glossary

Area Threshold	The Area Threshold setpoint determines the minimum amount of peak area that must be detected before a peak is recognized.
Assay	An assay is a solution with defined chip, chemicals, instrument methods, data analysis, data output settings and data display settings.
Audit Trail	Audit trails are available in the 2100 Expert Software only with the security pack installed. They are used to record the activities of the logged-in users and cannot be modified. The audit trails as well as log books are subject to data protection. Only authorized users are allowed to inspect them. They are saved with the data files or into an audit file repository, which is automatically archived.
Base pair	A base pair (bp) is a unit of two nucleobases bound to each other by hydrogen bonds. The length of DNA or RNA molecules is often expressed in base pairs.
Baseline	<p>A baseline is established just after the First Peak Time setpoint. After the overall baseline is established, a local baseline is calculated for each peak to compensate for baseline drift.</p> <p>For isolated peaks, the local peak baseline is simply a straight line connecting the Start Point of the peak with the End Point.</p> <p>For peaks that are very close together, an average baseline is used when the value between the peaks does not drop to the actual baseline.</p>
Baseline Plateau	This setpoint (found in the setpoint explorer) rejects brief, low slope areas such as at peaks and between non-baseline-resolved peaks. The signal is recognized to be at baseline whenever the slope of the data is less than the Slope Threshold setpoint (either positive or negative) for longer than the time set for the Baseline Plateau.
BMP file	BMP is the standard Windows image format. The BMP format supports RGB, indexed-color, grayscale, and bitmap color modes.
Bubble	If the tip of a pipette is not positioned all the way to the bottom of a well, bubbles can result (and sometimes bubbles happen even when you are very careful). The vortexing step that occurs after samples are loaded into the chip is designed to rid the wells of bubbles and is usually very effective. If a large bubble is seen at the bottom of a well, remove the sample from the well, pipette it back in, and continue with the loading procedure.
Center Point	After locating a start point, the peak find algorithm looks for the first negative slope value and saves the previous point as the center. If the value of the center point is less than the Minimum Peak Height, the algorithm starts looking for a new peak.
COM Port	See Serial port.
Concentration	Concentration is the amount of substance or solute per unit volume of solution. Concentration is measured in nanogram per microliter (ng/ $\mu$ L) within the 2100 Expert Software.
CSV file	Comma-separated variable file. The simplest form of file for holding tabular data. Data is listed in columns in a text file, each value being separated by a comma. Each new line represents a new set of data. Import and export with Microsoft Excel is possible.

Data Filtering	The first step 2100 Expert Software takes in analyzing raw data is to apply data filtering. Data filtering is done by means of a polynomial “filter” that is applied to the raw data. The setting for the Polynomial Order in the setpoint explorer determines the amount of data to be applied: the smaller the number, the more data that is applied and the more filtering that takes place.
Data Points	Data points are 0.05 seconds apart. Show Data Points is an option that enables the display of the data points used to generate the graph.
Electrode Cleaner	An electrode cleaner should be used to clean the electrodes after each run is complete. The cleaning procedure is slightly different depending upon the type of assay that was just performed. The electrode cleaner looks like a chip except that it is clear. With RNA assays you must use two different electrode cleaners: one for general cleaning using RNase-free water and another for decontamination using RNaseZAP. It is recommended to use a permanent marker to label the electrode cleaners so as not to mix them up.
Electrokinetic forces	Electrokinetic forces are used to move, switch and separate the samples. Active control over voltage gradients directs the movement of materials using the phenomenon of electrophoretic flow.
Electroosmotic Flow	A phenomenon that results from an electrical double layer formed by ions in the fluid and surface electrical charges immobilized on the capillary walls. When an electric field is applied, the bulk solution moves towards one of the electrodes. This phenomenon can be used to move fluids through microfabricated channels.
Electrophoresis	A standard technique of separating molecules on the basis of their mobility (charge-to-mass ratios). An electrical potential is applied across a capillary containing a sample in a fluid medium. Positive molecules migrate towards the cathode and negative molecules migrate towards the anode at different speeds, depending on their electrophoretic mobility.
Electrophoretic flow	A macroscopic phenomenon that results from an electrical double layer formed by ions in the fluid and surface electrical charges immobilized on the capillary walls. When an electric field is applied, the bulk solution moves towards one of the electrodes (cathode). Electrodes sit in the reservoirs that connect to the ends of the various channels. Electrode potentials are applied to the various reservoirs in a time-dependent fashion to move the fluid in the required direction. The gel-filled channels of the chips do not exhibit a measurable flow because of dynamic channel coating and viscosity of the polymer matrix.
End Point	The peak find algorithm looks for a leveling off when the value of the slope is less than the value set for the slope threshold. This is considered to be the end point of the peak.
End Time	This setpoint determines the time after the start of a run before which the last peak or fragment will be located (any peaks appearing after this time are ignored).
Filter Width	This setpoint determines the width of the polynomial (in seconds) to be applied to the data for filtering (noise reduction). The default depends on the assay selected. This setting should be less than twice the width of the peaks of interest or the peaks will be distorted. Peaks that are distorted by the filter have positive and negative peaks on both sides. To see an example of such distortion, increase the filter width to 5.
Firmware	The firmware is a program to control the hardware components of the Agilent 2100 Bioanalyzer instrument. It is downloaded from your computer to the Agilent 2100 Bioanalyzer instrument and controls, among others, data transfer or the measurement procedures.
GIF file	Graphics Interchange Format, GIF is a graphics file format that uses a compression scheme originally developed by CompuServe. Because GIF files are compressed, the file can be quickly and easily transmitted over a network. This is why it is the most commonly used graphics format on the World Wide Web.

## Glossary

Height Threshold	<p>The Height Threshold setpoint determines whether a peak is kept. It represents the minimal peak height. For each peak, the difference between the baseline height at the center position and the center height must be greater than the Height Threshold value.</p> <p>This setting is chosen in the setpoint explorer.</p>
HTML file	<p>HTML (Hyper Text Markup Language) is the authoring language used to create documents on the World Wide Web. HTML defines the page structure, fonts, graphic elements and hypertext links to other documents on the Web.</p>
JPG file	<p>Joint Photographic Experts Group Image File. A JPEG file is a compressed raster or bitmapped graphic image. When a JPEG is created, a range of compression qualities may be considered. JPEG compression is a lossy process, which means that you sacrifice quality for file size the more you compress the image (the highest quality images results in the largest file size). Whereas GIF images are limited to 256 colors (8-bit), JPEG images may contain millions of colors (24-bit) as well as additional information including PostScript clipping paths.</p>
Lab-on-a-chip	<p>The generic term for a microfluidic product, signifying a chemical process or material movement taking place on a microchip. In contrast to analysis in a standard laboratory that relies on human intervention at several stages to manipulate or observe samples and record results, the self-contained lab-on-a-chip represents an almost hands-free technology.</p> <p>Lab-on-a-chip technology means downsizing of analytical techniques from lab-scale to chip-scale:</p> <ul style="list-style-type: none"><li>- using techniques like electrophoresis, chromatography, and sieving.</li><li>- with fluorescence, absorbance, and MS detection.</li><li>- with a higher degree of automation, integrating multiple steps of a complex protocol into a miniaturized system.</li></ul>
Ladder	<p>Virtually any biochemical testing that can be done in a laboratory can theoretically be done on a chip.</p> <p>Each electrophoretic kit contains a ladder. A ladder contains DNA, RNA fragments or proteins of known sizes and concentrations.</p> <p>A ladder well is located at the bottom right of the chip. The ladder is analyzed first before sample analysis takes place.</p> <p>The peak sizes and markers defined for the ladder are assigned consecutively, starting with the first peak detected in the ladder. Peaks appearing above the upper marker do not have to be detected. The peak table for the ladder well shows the peak size and concentration.</p>
Lower Marker	<p>An internal standard that is added to a sample in a well to assist in determining size of the sample. The lower marker is the same as the first peak found in the ladder.</p>
Method	<p>Methods are available in the 2100 Expert Software only with the Security Pack installed. A method is referred to as an electrophoretic assay with additional information stored to it. This additional information includes instrument information, study information, report settings, and workflow definitions.</p>
Microfluidics	<p>The movement of liquids through micro-fabricated structures by means of electrical fields or pressure/vacuum, holding the promise of greater functionality with significantly improved reliability:</p> <ul style="list-style-type: none"><li>- small glass or plastic devices with micro-channels as experimental platform</li><li>- active control of fluids without moving parts on-chip through miniature electrodes or pumps controlled by software scripts</li><li>- emulation of conventional liquid pumps, valves, dispensers, reactors, separation systems, etc.</li><li>- capability of liquid transfer, separation, dilution, reactions and more</li></ul>



Molarity	Molarity is the number of moles of solute per liter of solution. Molarity is calculated as nanomoles per liter (nmol/L) within the 2100 Expert Software.
PDF file	PDF (Portable Document Format) is a file format created by Adobe Systems Incorporated that preserves all of the fonts, formatting, colors, and graphics of any source document, regardless of the software and computer platform used to create it.
Peak Baseline	A local peak baseline is calculated for each peak. For isolated peaks, the local peak baseline is simply a straight line connecting the start point with the end point. For peaks that are very close together, an average baseline is used when the value between the peaks does not drop to the actual baseline.
Peak Filter Width	The Peak Filter Width setpoint determines the minimum amount of time that must elapse before a peak is recognized.
Peak Height	The value at the center point of the peak minus the local baseline start value.
Point-to-Point Fit	This curve fit is composed of line segments between each pair of data points that are used to interpolate data between those points.
Polynomial Filter	The first step 2100 Expert Software takes in analyzing the raw data is to apply data filtering. Data filtering is done by means of a polynomial "filter" that is applied to the raw data.
Priming Station	Consists of a chip holder that has a syringe mounted on the lid that seals over the chip. The syringe is used to force the buffer solution loaded into the well marked "G" with a circle around it into all the passageways inside the chip prior to running it in the 2100 Bioanalyzer instrument.
Serial port	The serial ports (COM ports) are used to connect your computer with the Agilent 2100 Bioanalyzer instrument. If your computer does not have a serial port, you should use the Agilent USB to Serial Adapter (8121-1013).
Signature	Signatures are available in the 2100 Expert Software only with the Security Pack installed. All activities on data such as creating or modifying data must be confirmed by the user with an electronic signature (user name and password). By requesting this signature it is ensured that only authorized users can create or modify data.
Slope Threshold	The Slope Threshold setpoint determines the difference in the slope that must occur in order for a peak to begin. The inverse of this value is used to determine the peak end.
Standard Curve	The standard curve is obtained by plotting the size of the ladder peaks vs. time using a point-to-point fit. For each sample peak, the center time is interpolated from the Standard Curve to determine the peak size in base pairs.
Start Point	The peak find algorithm walks the data from time zero looking for a slope greater than the Slope Threshold. This is considered to be the start point of a peak. With RNA assays, individual peak start times can be moved manually by dragging the diamond-shaped start points shown in the single view.
Start Time	This setting determines the time after which the first peak or fragment will be located (any peaks appearing before this time are ignored). In RNA and Protein assays, the start time is shown on the single view display as a long-dashed vertical green line (note that this is true for protein assays when analysis is on; the start time is shown as a solid green line when analysis is off for protein assays). With RNA assays, another start time setting is available that determines the start time for an individual peak. With RNA assays, individual peak start times can be moved manually by dragging the diamond-shaped start points shown in the single view.

## Glossary

Size	Size or length of nucleic acids is calculated in base pairs (bp) in reference to a sample with molecules of known length.
Tool Tip	A small box containing text that describes the item indicated by the mouse pointer. To view a Tool Tip, position the mouse pointer over an object on the screen. Leave the mouse stationary for a moment and a Tool Tip (if one exists for that item) will appear.
TIF file	A file extension indicating one of a set of popular bitmap graphics formats. Tiffs are commonly used in DTP work because of their support for color specification.
Upper Marker	An internal standard that is added to a DNA or Protein sample in a well to assist in determining size and concentration of the sample. The upper marker is the same as the last peak found in the sizing ladder.
WAV file	A type of computer file used to store a sound digitally.
Workflow	The workflow defines the order of steps that need to be taken for a measurement to ensure data validity and data reliability. This includes steps such as the execution of methods, result reviews, and the final approval. The workflow definition is part of the methods and is available in the 2100 Expert Software only with the Security Pack installed.
WMF file	Windows Metafile. Windows metafile documents can contain any mix of vector and raster (or bitmapped) information to describe the contents of an image. WMF graphics are generally used on the Windows platform as a standard format for clip art and other graphically rich information such as charts.
XAD file	2100 Expert Software chip data file. The files contain raw data, assay information, data analysis setpoints, information on chip, samples and study, and the run log information.
XAC file	2100 Expert Software comparison file.
XLS file	Microsoft Excel spreadsheet file.
XML file	Extensible Markup Language files. XML is the Extensible Markup Language, a system for defining specialized markup languages that are used to transmit formatted data. XML is conceptually related to HTML, but XML is not itself a markup language. Rather it is a metalanguage, a language used to create other specialized languages. 2100 Expert Software uses the XML format to: - export chip data - save and load result flagging rules.
XSX file	2100 Expert Software assay file. The files contain the assay properties, data acquisition settings, and information on chip, samples, and study.
XVD file	2100 Expert Software verification result file. The files contain results of verification tests regarding the 2100 Bioanalyzer system hardware and software. xvd. files are stored in the ".\validation" subfolder of the 2100 Expert Software installation directory. For each verification run, an .xvd file is generated. Date and time of the verification run are included in the file name. Example: "Verification_23-05-2005_10-28-40".
Zero Baseline	All electropherograms produced with the 2100 Bioanalyzer system show some amount of background fluorescence. By default, the 2100 Expert Software enables the zero baseline function. Enabling this setting offsets the graphs shown for the individual wells but does not affect analysis. The mean of 100 points before the baseline time (derived when calculating well noise) is used as the zero baseline value. To remove the zeroing, disable the Zero Baseline box in the setpoint explorer (baseline calculation under Global and Advanced setting).

# Index

## A

- Accessories 244
- Agilent Online Store 244
- Assays
  - Creating new 163
  - Opening 165

## B

- Bioanalyzer tests 228

## C

- Comparing samples 139
- Comparison context 139
- Creating new assays 163

## D

- Data files 160
- Data points 78
- Data
  - Specify file names and directories 207

## F

- Fluorescence dye 53

## L

- Log
  - Run log 220
  - System Log 223

## M

- Marker 91
- Multi channel mode 75

## O

- Opening assays 165

## P

- Products 244

## R

- Raw data 160
- Region table 108
- Result flagging
  - Exporting rules 179
  - Importing rules 172
- RIN 91
- RNA integrity number 91
- RNA samples 91
- Run log 220

## S

- Show data points 80
- Sieving polymer 53
- Single channel mode 75
- Smear analysis 106
- Spare parts 244
- System Log 223

## U

- Undo zoom 79

## Z

- Zoom
  - Dot Plot 78
  - Histogram 78
  - Undo 79

## In this Manual

This manual provides 2100 Bioanalyzer system users with the following information:

- *Typographic conventions in this Manual*
- *Quick Start*
- *Looking at 2100 Expert*
- *Running and Evaluating Electrophoretic Assays*
- *Working with Chip Data and Assays*
- *Administering System Functions*
- *Running Instrument Diagnostics*
- *Performing Verifications*
- *Products, Spare Parts, and Accessories*
- *Related Documents*
- *Glossary*

© Agilent Technologies 2000-2020

Published in Germany  
02/2020

Document No: SD-UF0000050 Rev. D.00

