

Operator's Manual

General Purpose Water Baths

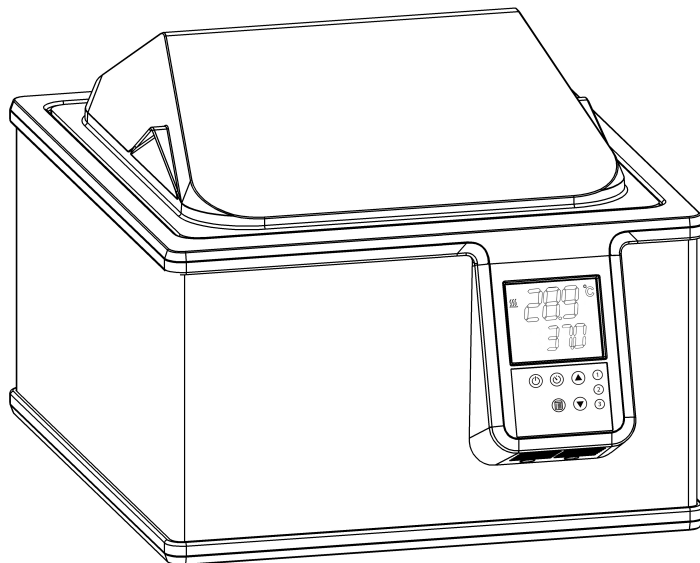

North American Catalog Number

	<u>120V</u>	<u>240V</u>
2L Digital Water Bath	89501-460	89501-462
5L Digital Water Bath	89501-464	89501-466
10L Digital Water Bath	89501-468	89501-470
20L Digital Water Bath	89501-472	89501-474
28L Digital Water Bath	89501-476	89501-478

Version: 1
Issued: 25 February 2014

Legal Address of Manufacturer

United States

VWR International, LLC
Radnor Corporate Center, Building One, Suite 200
P.O. Box 6660, 100 Matsonford Road
Radnor, PA 19087 U.S.A.
800-932-5000
<http://www.vwr.com>

Country of Origin

China

Table of Contents

Introduction	2
General Safety Information	2
Safety Recommendations	3
Regulatory Compliance & Testing	3
Unpacking Your Water Bath	4
Contents	4
LCD Display	5
Keypad	5
Installation and Startup	6
General Site Requirements	6
Adding Liquid to the Reservoir	6
Electrical Power	6
Controller Setup	7
Power On	7
Selecting the Temperature Unit	7
Setting the High Limit Value	7
Setting the Temperature Presets	7
Normal Operation	8
Keypad Controls	8
Turning Your Water Bath ON	8
Adjusting the Set Point Temperature	8
Setting and Using the Timer	8
Using the Temperature Presets	9
Entering a Calibration Offset	9
Resetting the Factory Default Values	9
Loss of Power Restart	10
Displaying the Firmware Version	10
Display Messages and Alarms	10
Routine Maintenance & Troubleshooting	11
Draining the Bath Reservoir	11
Resetting the Over Temperature/Low Liquid Level Safety	11
Cleaning the Bath	11
Troubleshooting Chart	12
Technical Information	12
Performance Specifications	12
Reservoir Fluids	13
Application Notes	13
Equipment Disposal (WEEE Directive)	13
Technical Service	14
Warranty	14









Introduction

Thank you for choosing this Water Bath. It is designed to handle a wide range of laboratory procedures including: incubation, inactivation and agglutination as well as most pharmaceutical, serological, biomedical and industrial procedures.

To ensure optimum temperature uniformity, your Water Bath features an energy efficient, large-area heater and thermostatic control. Its PID (Proportional Integral Derivative) microprocessor control system provides proportional heat control by anticipating the approach to your set point temperature and preventing overshoot. A redundant safety thermostat is standard on all models.

General Safety Information





When installed, operated and maintained according to the directions in this manual and common safety procedures, your Water Bath should provide safe and reliable temperature control. Please ensure that all individuals involved in the installation, operation or maintenance of this Water Bath read this manual thoroughly prior to working with the unit.

	This symbol marks chapters and sections of this instruction manual that are particularly relevant to safety. When attached to the unit, this symbol draws attention to the relevant section of the instruction manual.
	This symbol indicates that hazardous voltages may be present.
	This symbol indicates that hot surfaces or liquids may be present.
	This symbol marks information that is particularly important.
	This symbol indicates alternating current.
	These symbols on the Power Switch indicate that they place the main power supply ON/OFF.
	This symbol on the Power Button indicates that it places the unit in a standby mode. IT DOES NOT fully disconnect the unit from the power supply.
	This symbol indicates a protective conductor terminal.

**Read all instructions pertaining to safety, set-up and operation.
Proper operation is the user's responsibility.**

Safety Recommendations

To prevent injury to personnel and/or damage to property, always follow your workplace's safety procedures when operating this equipment. You should also comply with the following safety recommendations:

	WARNING: <ul style="list-style-type: none">• Always connect the power cord on this Water Bath to a grounded (3-prong) power outlet. Make certain that the outlet is the same voltage and frequency as your unit.• Never operate the Water Bath with a damaged power cord.• Always turn the Water Bath Off and disconnect mains power before performing any maintenance or service.
	WARNING: <ul style="list-style-type: none">• Never operate the Water Bath without bath fluid in the reservoir. Periodically check the reservoir to ensure that the liquid depth is within acceptable levels. Always refill the reservoir using the same bath fluid type that is already in the reservoir. Bath oil must not contain any water contaminants and should be preheated to the actual bath temperature before adding as there is an explosion hazard at high temperatures.• Use compatible bath fluids only.• Always drain all fluid from the reservoir before moving or lifting your Water Bath. Be sure to follow your organization's procedures and practices regarding the safe lifting and relocation of heavy objects.
	WARNING: Always allow the bath fluid to cool to ambient temperature before draining.
	WARNING: It is the user's responsibility to properly decontaminate the unit in the event hazardous materials are spilled on exterior or interior surfaces. Consult manufacturer if there is any doubt regarding the compatibility of decontamination or cleaning agents.
	CAUTION: If the equipment is used in a manner not specified by the manufacturer, the protection provided by the equipment may be impaired.

Regulatory Compliance & Testing

-  This product has been tested to the requirements of CAN/CSA-C22.2 No. 61010-1, second edition, including Amendment 1, or a later version of the same standard incorporating the same level of testing requirements.

ETL (60 Hz units)

UL 61010-1 / CSA C22.2 No. 61010-1, 2nd Edition 07/12/04 (R 10/28/2008)
IEC 61010-2-010: 2003, CSA C22.2 No. 61010-2-010:2004/07/01 Ed:2 (R2009)

CE (50 Hz units)

Low Voltage Directive 2006/95/EC
EN 61010-1, 2nd Edition Issued March, 2001
EN 61010-2-010 2nd Edition Issued October, 2003
EMC Directive 2004/108/EC
EN 61326-1: 2006
Machinery Directive 2006/42/EC Annex I

All Units - RoHS2 2011/65/EU

Unpacking Your Water Bath

Your water bath is shipped in a special carton. Retain the carton and all packing materials until the unit is completely assembled and working properly. Set up and run the unit immediately to confirm proper operation. Beyond one week, your unit may be warranty repaired, but not replaced. If the unit is damaged or does not operate properly, contact the transportation company, file a damage claim, then contact the company where your unit was purchased.



WARNING: Keep unit upright when moving. Be sure to follow your company's procedures and practices regarding the safe lifting and relocation of heavy objects.

Contents

The items included with your Water Bath are:

- Water Bath
- Gabled Reservoir Cover Assembly
- Sample Tray
- Operator's Manual on Flash Drive
- Quick-Start Guide

LCD Display

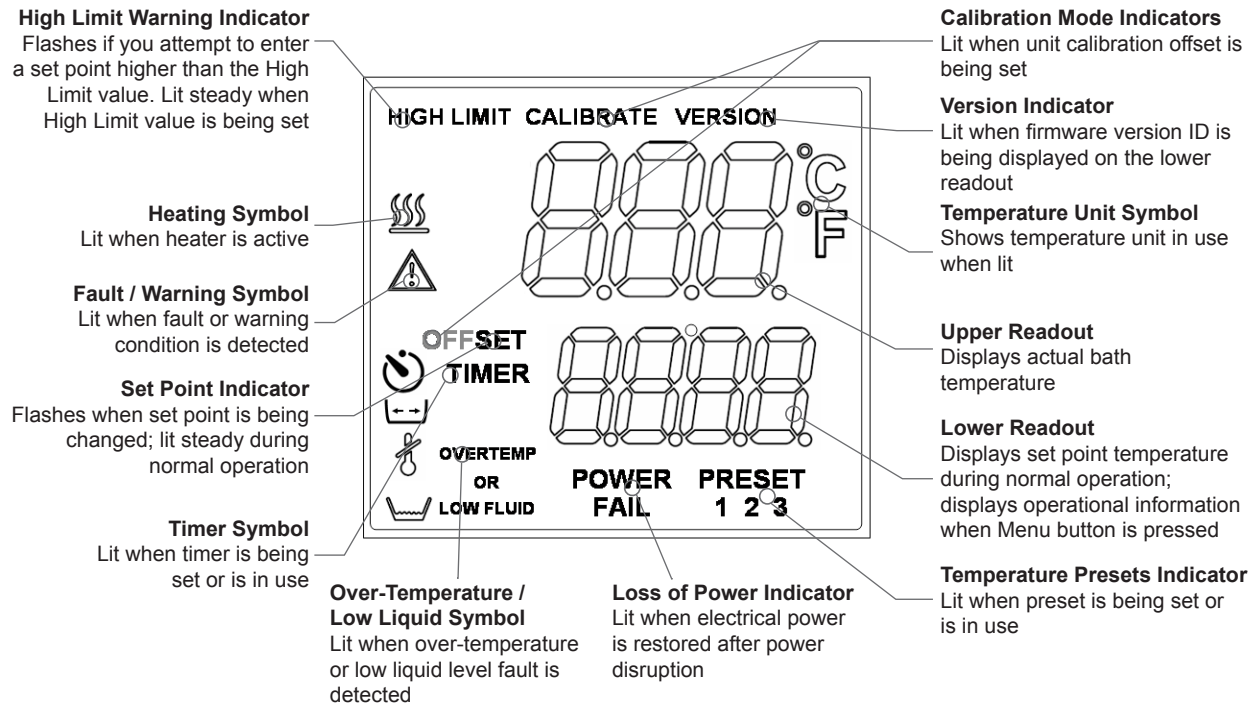

Keypad

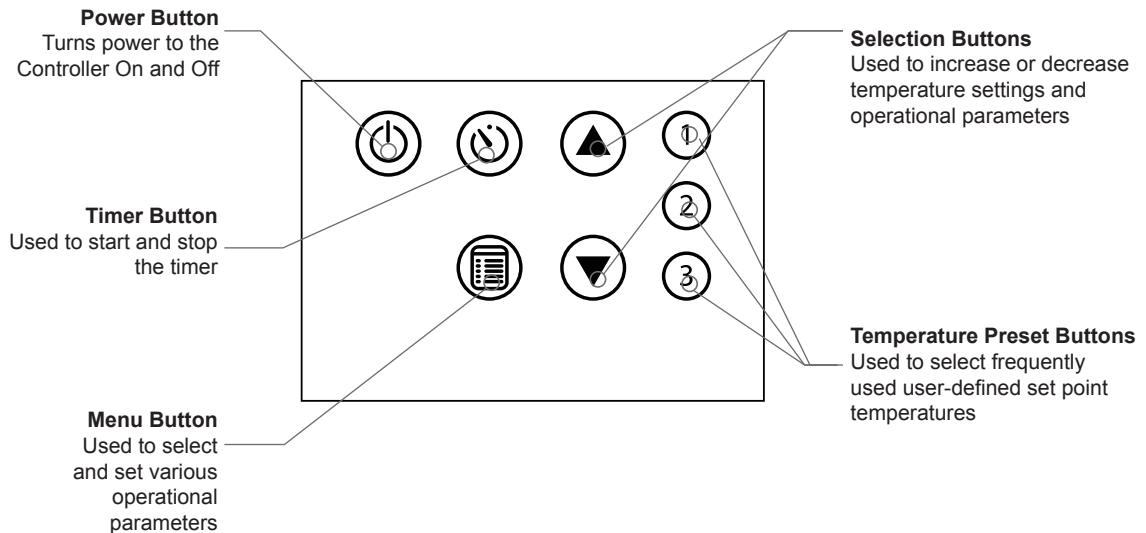

Installation and Startup

Your Water Bath is designed to be simple to setup and install. All that is required is a container for adding water or another suitable fluid to the bath reservoir.

General Site Requirements

Locate your Water Bath on a level surface in an area that is free from drafts and wide ambient temperature variations, such as near heater or air conditioning vents. Do not place it where there are corrosive fumes, excessive moisture, or in excessively dusty areas.

Avoid voltage drops by using properly grounded power outlets wired with 14 gauge or larger diameter wire and, if possible, be close to the power distribution panel. The use of extension cords is not recommended; this will reduce the potential for problems caused by low line voltage.

Adding Liquid to the Bath Reservoir



WARNING: Read the safety data sheet for the bath fluid being used carefully before filling reservoir.
WARNING: See *Technical Information, Reservoir Fluids* (page 13) for a list of compatible liquids.
WARNING: If the proper fluid level is not maintained, the unit could possibly be damaged (fluid level too low) or the bath may overflow (fluid level too high).



CAUTION: Fumes from acidic solutions may cause corrosion of the stainless steel reservoir. Care should be taken to maintain a neutral pH at all times.

Fill bath so that the liquid level is approximately one inch (2.54 cm) from top when samples are placed in the bath.

To ensure accurate reading of temperature, the fluid level should not be less than 2 inches (5.08 cm) from the bottom of the unit. Operation of the bath without fluid will not damage the heater, but will cause permanent discoloration of the tank and will not provide accurate temperature information.

Distilled water is preferred for temperatures from 10° to 90°C (50° to 194°F). A variety of fluids can be used with the bath depending on the application. The fluid must be compatible with 300 series stainless steel. See *Technical Information, Reservoir Fluids* (page 13) for a list of compatible fluids.

If using water, a few drops of algacide should be used to help prevent algae formation.



WARNING: Always drain all fluid from the reservoir before moving or lifting your Water Bath. Be sure to follow your organization's procedures and practices regarding the safe lifting and relocation of heavy objects.



WARNING: To avoid the potential for burns, allow the Water Bath to cool completely before cleaning or performing any maintenance.

Electrical Power



WARNING: The Water Bath's power cord must be connected to a properly grounded electrical receptacle. Make certain that this electrical outlet is the same voltage and frequency as your Water Bath. The correct voltage and frequency of your Water Bath are indicated on the identification label on the rear of the unit.



CAUTION: The use of an extension cord is not recommended. If one is necessary, it must be properly grounded and capable of handling the total wattage of the unit. The extension cord must not cause more than a 10% drop in voltage to the unit.

Insert the power cord into a properly grounded electrical outlet.

Place the Mains Switch on the rear of the unit in the On position. The three decimal points in the upper readout light to indicate that the Water Bath is in the Standby mode.

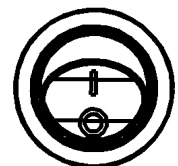





Controller Setup

Power On





1. Place the Mains Switch on the rear of the unit in the On position. The three decimal points in the upper readout light to indicate that the Water Bath is in the Standby mode.
2. Press . The actual bath temperature is displayed on the upper readout and the set point temperature is displayed on the lower readout. Both values are displayed to one decimal point. If the actual bath temperature is lower than the set point temperature, the unit will automatically begin heating and the heating symbol will light.

Selecting the Temperature Unit



1. Press  until °C or a °F appears on the lower readout.
2. If °C is shown, press  to change it to °F. If °F is shown, press  to change it to °C.
3. Press  or allow the display to timeout (~10 seconds) to accept the displayed temperature unit.

Setting the High Limit Value

This menu item allows you to enter a high temperature alarm value, and can establish a temperature above which a set point temperature cannot be entered. If you try to increase the set point to a temperature higher than the High Limit value, further increases will be blocked and the words HIGH LIMIT on the LCD will flash.











1. Press  until the words HIGH LIMIT appear on the LCD; the current High Limit value will appear on the lower readout.
2. Use the  and  buttons to set the high limit value to the desired temperature; this value may be set as high as 105°C (221°F).
3. Press  or allow the display to timeout (~10 seconds) to accept the displayed High Limit value. The words HIGH LIMIT will no longer be lit.

Setting the Temperature Presets

1. Press  until PRESET appears on the lower readout.
2. Use the  and  buttons to adjust the set point displayed on the lower readout to the desired temperature.











NOTE: Steps 3 through 7 below are optional.

3. Press  until the word TIMER is displayed on the LCD; the two left hand digits in the lower readout will begin flashing.
4. Use the  and  buttons to set the time duration in hours; this value may be set anywhere from 00 to 99 hours.
5. Press  again; the two right hand digits in the lower readout will begin flashing.
6. Use the  and  buttons to set the time duration in minutes; this value may be set anywhere from 00 to 59 minutes.
7. Press  or allow the display to timeout (~10 seconds) to accept the displayed Time Duration value.
8. Press and hold the Preset button (,  or ) you wish to associate with the set point and time optional timer values you entered for ten seconds to accept. The unit will beep to indicate the Preset has been accepted.

Normal Operation

Keypad Controls





Power		Turns the Controller On and Off.
Menu		Used to select and set temperature units, timer time duration, high limit temperature and calibration offset. Also used to display the firmware version ID.
Timer		Used to start, pause and reset the timer.
Selection	 	Used to increase/decrease temperature set point and other operational settings/values.
Temperature Presets (1, 2, 3)	  	Used to select one of three user-defined set point temperatures and optional time duration.

Turning Your Water Bath On











1. Place the Mains Switch on the rear of the unit in the On position. The three decimal points in the upper readout light to indicate that the Water bath is in the Standby mode.
2. Press . The actual bath temperature is displayed on the upper readout and the set point temperature is displayed on the lower readout. Both values are displayed to one decimal point. If the actual bath temperature is lower than the set point temperature, the unit will automatically begin heating and the heating symbol will light.

Adjusting the Set Point Temperature

This is the temperature at which the fluid in your bath will be maintained. It may be set to one-tenth of a degree. The factory default set point is +20.0°C/+68°F.

1. Press the  or  button. The word SET on the LCD will begin flashing.
2. Use the  and  buttons to adjust the set point temperature to the desired value. Press  or allow the display to timeout (~10 seconds) to accept the new value; the word SET on the LCD will be lit steady.

Setting and Using the Timer

1. Press  until TIMER appears on the LCD; the two left hand digits in the lower readout will begin flashing.
2. Use the  and  buttons to set the time duration in hours; this value may be set anywhere from 00 to 99 hours.
3. Press  again; the two right hand digits on the lower readout will begin flashing.
4. Use the  and  to set the time duration in minutes; this value may be set anywhere from 00 to 59 minutes.
5. Press  or allow the display to timeout (~10 seconds) to accept the displayed Time Duration value.
6. Press  to start the timer;  and the word TIMER on the LCD will light. To pause the Timer, press  a second time; press again to restart the Timer from the point at which it was stopped. To reset the Timer to 00:00, press and hold  for two seconds.

The Timer counts down until it reaches 00:00, beeps and then begins counting up. This is intended to inform you about how much time has elapsed since the timer reached 00:00. To clear the Timer Value, place the unit in Standby mode and press  to return from Standby mode.



NOTE: When the Timer is operating, the lower readout alternates between the time remaining (or elapsed) and the temperature set point at 5 second intervals.

Using the Temperature Presets

Press the desired Preset button (①, ② or ③). The word PRESET and the number associated with that preset will light on the LCD. If the Preset includes a Timer function, the word TIMER and ⏰ will also light. The actual bath temperature and the set point temperature / time (alternating) will be displayed on the upper and lower readouts, respectively (set point only if there is no timer function associated with the Preset).



NOTE: When the Preset includes a Timer function, ⏰ will light and the timer will begin counting down when the actual bath temperature is within $\pm 0.5^\circ$ of the set point temperature. The Timer can also be activated manually by pressing the Timer button.

Entering a Calibration Offset

This menu item allows you to offset all bath temperature readings by -7 to +7°C. For example, if the Calibration Offset is set to +0.5° the bath will display temperature readings of 20°C, 50°C and 70°C as 20.5°C, 50.5°C and 70.5°C, respectively.

The Calibration Offset is always set in °C. If you have selected °F as the temperature unit, the Water Bath automatically converts the °C calibration offset value to the correct °F value when normal operation is resumed.

To prevent the Calibration Offset from being changed unintentionally, the following power down/power up sequence is required to enable the Calibration Offset function:



NOTE: If the operator tries to enter a Calibration Offset without following the proper power down/power up sequence, the words CALIBRATION OFFSET on the LCD will flash.

1. Place the Mains Switch on the rear of the unit in the Off position.
2. Press and hold ⏻ while returning the Mains Switch to the On position.
3. When the unit enters Standby (the three decimal points in the upper display lit), release ⏻.
4. Press ⏰.
5. Press ⏻ until the words CALIBRATION OFFSET light on the LCD. The actual bath temperature will be displayed in degrees C on the upper readout and the current Calibration Offset value will be displayed in degrees C on the lower readout.
6. Use the ▲ and ▼ buttons to set the Calibration Offset to the desired value. As the Calibration Offset value is entered, the reading on the upper display will also change to reflect the new calibration offset value.
7. Press ⏻ or allow the display to timeout (~10 seconds) to accept the displayed Calibration value. The words CALIBRATION OFFSET will no longer be lit.

The Calibration Offset function will remain enabled until the unit is turned Off by pressing ⏻.

Resetting the Factory Default Values

1. Press ⏻ to turn the Water Bath Off.
2. Place the Mains Switch on the rear of the unit in the Off position.
3. Return the Mains Switch to the On position while pressing and holding either the ▲ or ▼ button.



The factory default values are:

Operational Parameter	Factory Default Value
Temperature Set Point	20°C/68°F
Temperature Scale	°C
Timer	00:00
High Limit	99.9°C/211.8°F
Calibration Offset	0.0°C
Preset 1	Set Point: 37°C Timer: 0
Preset 2	Set Point: 44°C Timer: 0
Preset 3	Set Point: 70°C Timer: 0



























Loss of Power Restart

In the event that electrical power is lost while your Water Bath is in use, it will begin operating automatically at the set point temperature once power is restored. The timer will begin counting up from the point at which power was restored. POWER FAIL will appear on the display to alert you that there was a power disruption. To clear the message, turn the bath Off and then back On again by pressing .

Displaying the Firmware Version

The version number for the Water Bath's firmware is accessed by pressing  until the word VERSION appears on the LCD. The version number will be displayed on the lower readout; this is a read-only value. Press  or allow the display to timeout (~10 seconds) to exit the Menu function.

Display Messages and Alarms

Symbol and/or Word	Description	Comments/Corrective Action
HIGH LIMIT (flashing)	Warning: The operator is attempting to enter temperature set point that is above the High Limit temperature value.	Increase the High Limit temperature value or decrease the set point temperature.
 OVERTEMP OR LOW FLUID	Fault: The liquid in the bath has dropped too low or the temperature of the bath fluid has exceeded the Safety Set temperature. Power to the heater will remain Off until the over-temperature thermostat resets.	Fluid level in the reservoir has fallen below minimum level; remove power, allow bath to come to room temperature and add fluid. Fluid temperature is higher than one or both Over-Temperature Safety thermostats. Remove power and allow bath to come to room temperature; if problem persists, consult factory.
CALIBRATION OFFSET (flashing)	Warning: The operator is attempting to enter a Calibration Offset value without first performing the proper power down/power up sequence.	Place Mains Switch on rear of unit in Off position. Press and hold  while returning Mains Switch to On position. Release  when unit enters Standby mode. Press  on keypad and then press  until CALIBRATION OFFSET appears on LCD.
POWER FAIL	Informational: Indicates that there was a loss of electrical power during operation.	Press  to turn the Water Bath Off and then back On. This will clear the message.
SET (flashing)	Informational: Indicates that the temperature set point is being changed.	Press  or  until desired set point temperature is displayed on lower readout. Press  or allow the display to timeout to accept.
°C or °F on lower readout.	Informational: Indicates that the temperature unit is being changed.	Press  to change °C to °F; press  to change °F to °C. Press  or allow the display to timeout to accept.
TIMER	Informational: Indicates that the timer is being set.	Use the  or  buttons to increase/decrease the time duration. Press  or allow the display to timeout to accept.
HIGH LIMIT (steady)	Informational: Indicates that the high limit value is being changed. Warning: Indicates that the bath temperature has exceeded the high limit value for more than 5 seconds.	Press  or  until desired high limit temperature is displayed on lower readout. Press  or allow the display to timeout to accept. Allow bath temperature to fall below the High Limit Value. Place unit in Standby mode and press  to return from Standby mode. Reset factory default values.
CALIBRATION OFFSET (steady)	Informational: Indicates that the calibration offset value is being changed.	Press  or  until desired calibration offset is displayed on lower readout. Press  or allow the display to timeout to accept.
PRESET 1, 2 or 3	Informational: Indicates that the bath is operating using the indicated Preset set point temperature and timer (optional) values.	No action required.
 TIMER	Informational: Indicates that the timer is being used.	Press and release  to pause timer. Press and hold  for two seconds to reset to 00:00.
	Informational: Indicates that heat is being applied to the bath.	This symbol is lit steady while the bath is heating to the set point temperature and flashes when the set point temperature is being maintained.
--- Beeping Pattern	Warning: Sensor Failure	Turn the Water Bath Off. Place mains switch in the Off position. Unplug the unit and contact factory.

Routine Maintenance & Troubleshooting



WARNING: Hazardous voltages may be present. Disconnect power before performing maintenance.



WARNING: Always allow the bath to cool to ambient temperature before performing any maintenance.

Draining the Bath Reservoir

Water Baths with 10, 20 and 28 liter reservoirs have a drain port located on the rear of the unit. To drain fluid from the bath reservoir, place a suitable container beneath the drain port and remove the cap and o-ring.

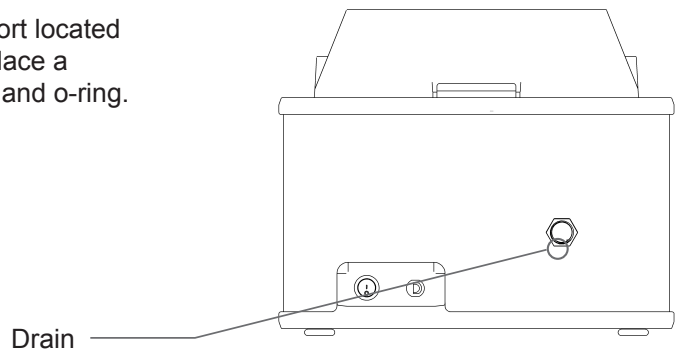



WARNING: Be sure to reinstall the cap on the drain outlet before refilling the bath reservoir. Always verify the o-ring is properly installed inside the cap.

Resetting the Over-Temperature/Low Liquid Level Safety

Also see *Display Messages and Alarms* (page 10) and the *Troubleshooting Chart* (page 12).

For optimal protection, your Water Bath incorporates redundant over-temperature safeties. These over-temperature/low liquid level safeties automatically remove power from the heater in the event that the bath temperature exceeds their factory set temperature settings.

While these safeties are designed to automatically reset when the bath returns to a temperature below the factory set safety settings, we recommend that you take the following actions when the over-temperature/low liquid level warning is activated.

1. Press  to place the Water Bath in the Standby mode.
2. Allow the liquid in the Water Bath to cool to ambient temperature.
3. If the liquid level in the bath is too low, add liquid as required.
4. Press .

If the problem persists, contact the factory.

Cleaning the Bath

Thoroughly clean the bath before each use. Use only mild soap and water when cleaning. Do not use steel wool as damage to the unit may result. Non-steel scouring pads are acceptable.

The entire unit is housed in a tough, well-insulated powder-coated steel casing that is corrosion and chemical resistant.

Troubleshooting Chart

Problem	Cause	Corrective Action
No display	No power to unit	Check that power cord is plugged into an operating electrical outlet.
	Mains Switch in Off position	Check that Mains Switch on the rear of the unit is in the On position.
No heating	Set point lower than bath temperature	Check set point temperature; increase as required.
	Bath temperature above High Limit temperature	Verify that High Limit temperature is higher than current set point temperature; adjust as required (see page 7).
	Liquid level in bath is too low	Check that liquid level is at least 2 inches (5.08 cm) above bottom of tank; add fluid as required.
Insufficient heating	Improper line voltage	Check that line voltage meets specifications.
	Recent change in set point or heat load	Allow sufficient time for bath temperature to stabilize when changes in heat load or set point are made.
	Bath cover not in place	Check that bath cover is in place.
Inaccurate bath temperature	Incorrect calibration	Adjust Calibration Offset as required (see page 9).

Technical Information

Performance Specifications

Working Temperature: Ambient +5°C to 100°C (ambient +10° to 212°F)
60°C (140°F) without cover

Temperature Uniformity: ±0.2°C @ 37°C (±0.4°F @ 98.6°F)

Temperature Stability: ±0.1°C (±0.2°F)

Reservoir Size	Reservoir Dimensions (L x W x D)	Heater Wattage	Electrical Requirements	
			120 V, 60 Hz	240 V, 50 Hz
2 liter	3.9 x 4.3 x 6" 9.9 x 10.9 x 15.2 cm	120	WB02**1* 1.1 A	WB02**2* 0.5 A
5 liter	5 x 10.8 x 6" 12.7 x 27.4 x 15.2 cm	360	WB05**1* 3.3 A	WB05**2* 1.6 A
10 liter	10.6 x 11.6 x 6" 26.9 x 29.5 x 15.2 cm	1000	WB10**1* 8.6 A	WB10**2* 4.5 A
20 liter	9.5 x 17.5 x 5" 24.1 x 44.5 x 15.2 cm	1400	WB20**1* 12.0 A	WB20**2* 6.0 A
28 liter	9.5 x 17 x 8" 24.1 x 43.2 x 20.3 cm	1400	WB28**1* 12.0 A	WB28**2* 6.0 A

Environmental Conditions

Indoor use only

Maximum Altitude: 2000 meter

Operating Ambient: 5° to 40°C (41° to 104°F)

Relative Humidity: 80%, non-condensing

Installation Category: II

Pollution Degree: 2

Reservoir Fluids



WARNING: Do not operate unit with any potentially flammable materials, as a fire hazard may result.



CAUTION: Fumes from acidic solutions may cause corrosion of the stainless steel reservoir. Care should be taken to maintain a neutral pH at all times.

Stay within the fluid's normal range for best temperature stability and low vaporization. At fluid's high temperature extreme:

- A fume hood may be required to prevent the buildup of vapors inside the room.
- Fluid loss from vapor will have to be frequently replenished.
- Caution must be taken to stay well below the fluid's flashpoint.

Application Notes

For optimum results, maintain fluid level throughout the operating period, adding fluid as needed. Attempt to refill fluid at same temperature as bath.

Use the bath lid and/or hollow plastic floating balls to help prevent heat and vapor loss.

This unit is designed for indoor use only with an allowable ambient temperature between +5°C to 40°C (41° to 104°F) and relative humidity not greater than 80%.

Equipment Disposal (WEEE Directive)

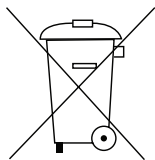

This equipment is marked with the crossed out wheeled bin symbol to indicate it is covered by the Waste Electrical and Electronic Equipment (WEEE) Directive and is not to be disposed of as unsorted municipal waste. **Any products marked with this symbol must be collected separately, according to the regulatory guidelines in your area.**

It is your responsibility to correctly dispose of this equipment at lifecycle-end by handing it over to an authorized facility for separate collection and recycling. It is also your responsibility to decontaminate the equipment in case of biological, chemical and/or radiological contamination, so as to protect the persons involved in the disposal and recycling or the equipment from health hazards. By doing so, you will help to conserve natural and environmental resources and you will ensure that your equipment is recycled in a manner that protects human health.

Requirements for waste collection, reuse, recycling and recovery programs vary by regulatory authority at your location. Contact your local responsible body (e.g., your laboratory manager) or authorized representative for information regarding applicable disposal regulations.

Technical Service

Web Resources

Visit the VWR's website at www.vwr.com for:

- Complete technical service contact information
- Access to VWR's Online Catalogue, and information about accessories and related products
- Additional product information and special offers

Contact us for more information or technical assistance. Contact your local VWR representative or visit www.vwr.com.

Warranty

VWR International warrants that this product will be free from defects in material and workmanship for a period of two (2) years from date of purchase. If a defect is present, VWR will, at its option, repair, replace, or refund the purchase price of this product at no charge to you, provided it is returned during the warranty period. This warranty does not apply if the product has been damaged by accident, abuse, misuse, or misapplication, or from ordinary wear and tear.

For your protection, items being returned must be insured against possible damage or loss. This warranty shall be limited to the replacement of defective products. IT IS EXPRESSLY AGREED THAT THIS WARRANTY WILL BE IN LIEU OF ALL WARRANTIES OF FITNESS AND IN LIEU OF THE WARRANTY OF MERCHANTABILITY.