

## INSTRUCTIONS

### FISHER DRY BATH INCUBATORS

Catalog Nos.	11-718
	11-718-2
	11-718-4
	11-718-6
	11-718-8

Fisher Dry Bath Incubators provide controlled heat for a wide variety of clinical and general chemistry applications. They operate through a temperature range from slightly over ambient to 130 C. The various models can accommodate 1, 2, 3, 4, or 6 dry blocks. Each unit is controlled by two adjustable thermostats, one for operation up to about 60 C, and the other for up to 130 C. A fully-insulated pad-type heating element is bonded directly to the entire underside of the dry block support plate to provide even heat distribution. The support plate is made from aluminum for rapid heat transfer.

Each model is designed to be used with any of eight different accessory dry blocks. (See the Accessories Section for a listing of catalog numbers). Blocks are made from solid aluminum with a black anodized finish. Each block is marked so that every well can be identified. Dry blocks can handle a variety of tubes from 1.5 ml microcentrifuge tubes to 25 mm diameter tubes. All of these accessory dry blocks are interchangeable.

Typical applications for these dry baths include incubation, culture inactivations, enzyme reactions, melting and boiling points, and many other procedures that require controlled heat.

#### Performance Characteristics

Temperature Range: Slightly Above Ambient to 130 C

Note: Tolerances on temperature ranges are approximately -5 to +10 C. Maximum attainable temperature may exceed 140 C.

Uniformity: \* + or - 0.5 C

\*Variation, at a given time, of a sample temperature from the average of all sample temperatures within a dry block (at 37C). Temperature variation between blocks may exceed this spec.

#### Capacities:

11-718	1 Block
11-718-2	2 Blocks
11-718-4	3 Blocks
11-718-6	4 Blocks
11-718-8	6 Blocks

#### Power Requirements:

11-718	115V, 50/60 Hz, 90 Watts
11-718-2	115V, 50/60 Hz, 180 Watts
11-718-4	115V, 50/60 Hz, 270 Watts
11-718-6	115V, 50/60 Hz, 360 Watts
11-718-8	115V, 50/60 Hz, 540 Watts

#### Physical Data:

11-718	9in X 8in X 3.5in	4.6 lbs
11-718-2	9in X 8in X 3.5in	4.7 lbs
11-718-4	9in X 11in X 3.5in	5.8 lbs
11-718-6	12.5in X 8.5in X 3.5in	6.1 lbs
11-718-8	12.5in X 11in X 3.5in	7.4 lbs

#### Unpacking

These Dry Bath Incubators are shipped in a single carton, completely assembled. Each is supplied with this manual, a warranty card, and a Dry Block Handle (for handling or moving dry blocks). The warranty card should be completed and returned as soon as possible. In cases where shipping damage is observed, keep the unit and carton intact, including the packaging materials, and file a claim with the final carrier.

Note; Because of the wide variety of applications and sample block designs, dry blocks are not included with dry baths. The user must select and order the blocks that best suit the particular application.

#### OPERATION

Each dry bath is equipped with two temperature controls (thermostats), a selector switch, and a red-lensed lamp which indicates heater operation. The lamp comes on when the controlling thermostat, as selected by the switch, closes to supply power to the heater. Once the dry bath reaches thermal equilibrium, the cycling of the lamp, and the heater, should continue on a regular basis. In case of a malfunction, such as a heater failure or thermostat stuck in the closed position, the lamp will remain on. Should the thermostat fail with the contacts open, the light will remain off.

1. Place the unit on a flat, level surface, in an area free of drafts and temperature changes. (Note; Drafts and ambient temperature changes will adversely affect temperature constancy and uniformity.)

2. Make sure that bath cavity is free of foreign matter, then place empty dry block(s) into bath cavity.
3. Connect unit to an appropriate, grounded power source as specified on the unit's data plate.
4. Insert an immersion type thermometer, graduated to the desired temperature range, into the thermometer well in the dry block. Note; For more precise measurements, the thermometer can be placed into the sample tube or a similar tube adjacent to the sample tube.
5. Set the three-position switch at the appropriate setting:
  - "Low" setting for ambient to 60 C
  - "High" setting for 50C to 130 C
6. Adjust the appropriate temperature control to a setting that approximates the desired temperature. The following can be used as a general guideline. On the Low temperature control a setting of "0" will be ambient, "6" or "7" about 40 C, and "10" about 60 C. On the High temperature control a setting of "0" will heat samples to about 50 C, "5" will heat to about 90 C, and "10" about 130 C.
7. As the dry bath is heating, monitor the temperature reading on the thermometer and observe the indicator lamp. If the thermometer reading exceeds the desired temperature, reduce the temperature control setting. When the lamp cycles on and off at regular intervals (or "flickers"), the unit has reached equilibrium. If the dry bath is not at the desired temperature, adjust the temperature control in the appropriate direction.
8. Once the dry bath has stabilized at the desired temperature, samples may be inserted into the blocks.
9. Use the Dry Block Handle to remove blocks. Be sure that the Dry Block Handle is securely engaged with the block before lifting it from the bath.

#### CAUTION:

- Be sure dry bath is connected to only grounded power sources of the appropriate voltage.
- Never heat samples beyond safe levels.
- Tightly capped sample tubes may burst when heated.
- Use the Dry Block Handle to move the dry blocks.
- Turn the Selector Switch to the Off position and unplug unit when not in use.

#### FOR BEST RESULTS:

- Use Dry Bath Incubators in an area with a constant ambient temperature and no drafts.
- All samples should be placed in identical tubes, filled to equal levels no higher than top of block. All sample tubes should be placed in identical blocks.

## MAINTENANCE

These dry baths require no periodic maintenance other than routine cleaning with mild cleaning products. Be sure units are unplugged prior to cleaning. Never use abrasives or harsh chemicals to clean units. Never immerse units in liquids or pour liquids onto the dry block support plate.

## SERVICE

It is recommended that dry baths be serviced only by those qualified in instrument maintenance. Service is available at any of the Instrument Service District Offices located throughout the country. If you need service or service information, please contact the office nearest to you. The representatives there can issue a return authorization number, if necessary. Emergency, on-site service calls are not covered under the warranty.

### Unit Disassembly

#### WARNING: Unplug unit prior to disassembly.

1. Loosen set screws and remove temperature control knobs.
2. Turn unit upside-down and remove four screws.
3. Remove base by first lifting at rear, then moving forward to clear temperature control stems.
4. Note the routing of wires and the location of insulation so that the unit can be properly re-assembled.
5. Carefully remove insulation.

### Thermostat Replacement

1. (Optional) Remove screws that attach Heater Base Assembly to the Top Cover Assembly.
2. Observe wiring connections, then remove two wires connected to appropriate thermostat.
3. Remove fastener holding thermostat in place, then remove thermostat.
4. Connect wires to new thermostat and install.
5. Re-attach Heater Base Assembly if it has been removed.
6. Position base onto unit and check alignment of thermostat shaft with center of hole in front of base. Remove base and reposition thermostat as required, then tighten securely.

### Heater Replacement

1. The heater is permanently bonded to the dry block support plate, and can only be replaced as a pre-assembled unit. This assembly is called a Heater Base Assembly.
2. Remove the fasteners which attach the thermostats to the dry block support plate.
3. Remove the fasteners that attach the dry block support plate to the dry bath top cover assembly.
4. Locate and remove the splices at the end of the heater leads.

5. Connect the new heater leads, making sure that the connections are secure and properly insulated.
6. Attach the new dry block support plate and thermostats (see Thermostat Replacement section).

## ACCESSORIES

Item	Capacity	Cat. no.
Dry Block, 24 tubes, 1.5ml		11-718-9
Dry Block, 30 tubes, 6mm diameter		11-718-10
Dry Block, 20 tubes, 10mm diameter		11-718-12
Dry Block, 20 tubes, 13mm diameter		11-718-14
Dry Block, 12 tubes, 16mm diameter		11-718-16
Dry Block, 8 tubes, 20mm diameter		11-718-18
Dry Block, 6 tubes, 25mm diameter		11-718-20
Dry Block, Combination		11-718-22
	6 tubes, 6mm diameter	
	5 tubes, 13mm diameter	
	3 tubes, 25mm diameter	

### Selector Switch or Indicator Lamp Replacement

1. Note wiring connections of device to be replaced, then remove wires.
2. Squeeze tabs that hold device in place, then push out through front of base.
3. Install new device into appropriate hole in base.
4. Reconnect wires.

### Re-Assembly

1. Position insulation over heater.
2. Make sure that wires are routed so as not to come in contact with heater.
3. Properly position base, checking alignment of thermostats as in Thermostat Replacement section.
4. Fasten base to top cover, and replace knobs.

### Replacement Parts

Item	Part Number
Thermostat, Low Temp	83310
Thermostat, High Temp	83311
Selector Switch	83364
Indicator Lamp	64057
Dry Block Handle	83326
Heater Base Assembly for 11-718	83305
Heater Base Assembly for 11-718-2	83306
Heater Base Assembly for 11-718-4	83307
Heater Base Assembly for 11-718-6	83308
Heater Base Assembly for 11-718-8	83309

**Part No. 83315**  
**Instructions for Dry Bath Incubators**  
 Rev. A. (12/91)

**Fisher Scientific**  
**711 Forbes Ave**  
**Pittsburgh, Pa. 15219**

**1-800-388-8355**

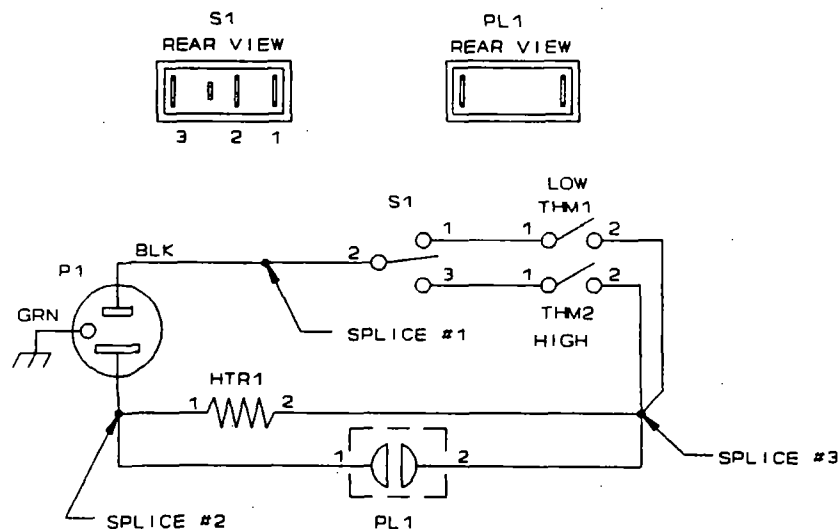

SCH E M A T I C

FOR REPAIR INFORMATION OR REPLACEMENT PARTS ASSISTANCE, PLEASE CONTACT YOUR NEAREST CUSTOMER SUPPORT CENTER LISTED IN THE BACK OF THIS MANUAL.

SERVICE MANUAL  
FOR  
FISHER AUTOMATIC CO<sub>2</sub>  
WATER-JACKETED INCUBATORS

Models covered by this manual:

116875	1168710
116875H	1168710H
1168751	11687101
1168751H	11687101H

**NOTICE**

THE MATERIAL IN THIS MANUAL IS FOR INFORMATION PURPOSES ONLY. THE CONTENTS AND THE PRODUCT IT DESCRIBES ARE SUBJECT TO CHANGE WITHOUT NOTICE. FISHER SCIENTIFIC MAKES NO REPRESENTATIONS OR WARRANTIES WITH RESPECT TO THIS MANUAL. IN NO EVENT SHALL FISHER SCIENTIFIC BE LIABLE FOR ANY DAMAGES, DIRECT OR INCIDENTAL, ARISING OUT OF OR RELATED TO THE USE OF THIS MANUAL.

FISHER SCIENTIFIC  
CORPORATE HEADQUARTERS  
711 FORBES AVENUE  
PITTSBURGH, PA 15219

REV. D DATED 9-11-95

MANUAL P/N 512S-AZ-4



## SERVICE MANUAL TABLE OF CONTENTS

SECTION	PAGE
INTRODUCTION .....	1
PART 1	
1.1 DESCRIPTION OF SYSTEM OPERATION .....	1
1.2 TROUBLESHOOTING THE INCUBATOR SYSTEM .....	4
1.3 CALIBRATION .....	6
1.3.1 TEMPERATURE DISPLAY CALIBRATION .....	6
1.3.2 SAFETY SET POINT CALIBRATION .....	6
1.3.3 RELATIVE HUMIDITY CALIBRATION .....	7
1.3.4 CO <sub>2</sub> CALIBRATION .....	7
1.3.5 THERMOCONDUCTIVE CO <sub>2</sub> SENSORS .....	8
1.3.6 GAS SAMPLES .....	8
PART 2	
TEST PROCEDURES .....	9
2.1 POWER SWITCH/EMI FILTER .....	9
2.2 TRANSFORMER .....	10
2.3 POWER PRINTED CIRCUIT BOARD .....	10
2.3.1 POWER BOARD CALIBRATION .....	11
2.4 CONTROLLER CIRCUIT BOARD .....	12
2.5 CHAMBER HEATER .....	12
2.6 DOOR HEATER .....	13
2.7 AUXILIARY CHAMBER HEATER .....	13
2.8 FAN MOTOR .....	13
2.9 CO <sub>2</sub> SOLENOID VALVE .....	14
2.10 FLOAT SWITCH .....	14
2.11 TEMPERATURE SENSOR .....	15
2.12 T/C CO <sub>2</sub> SENSOR .....	15
2.13 I/R CO <sub>2</sub> SENSOR .....	15
2.14 RELATIVE HUMIDITY SENSOR .....	15
PART 3	
REMOVAL/REPLACEMENT PROCEDURES .....	17
3.1 SHELF SUPPORTS & BLOWER DUCT .....	17
3.2 SOLENOID VALVES .....	17
3.3 T/C CO <sub>2</sub> SENSOR .....	17
3.4 I/R CO <sub>2</sub> SENSOR ASSEMBLY .....	17
3.5 TEMPERATURE SENSOR .....	18
3.6 RELATIVE HUMIDITY SENSOR .....	18
3.7 FAN MOTOR .....	18
3.8 CARTRIDGE HEATERS .....	18
3.9 AIR HEATER .....	19
3.10 DOOR HEATERS .....	19
3.11 AUXILIARY CHAMBER HEATER .....	19

SERVICE MANUAL TABLE OF CONTENTS (cont.)

SECTION	PAGE
3.12 FLOAT SWITCHES .....	20
3.13 INNER GLASS DOOR .....	20
3.14 OUTER DOOR .....	20
3.14.1 SINGLE CHAMBER UNITS .....	20
3.14.2 DOUBLE CHAMBER UNITS/LOWER DOOR .....	21
3.14.3 DOUBLE CHAMBER UNITS/UPPER DOOR .....	22
3.15 WATER-JACKET CHAMBER MODULE .....	23
3.15.1 SINGLE CHAMBER UNITS .....	23
3.15.2 DOUBLE CHAMBER UNITS/LOWER DOOR .....	24
3.15.3 DOUBLE CHAMBER UNITS/UPPER DOOR .....	25
3.16 FUSES .....	26
3.17 CONTROLLER BOARD ASSEMBLY .....	26
3.18 POWER CIRCUIT BOARD .....	27
3.19 TRANSFORMER .....	27
3.20 EMI FILTER .....	27
3.21 REPLACEMENT PARTS LIST .....	28
Model 5 (100/120 Volts - 50/60 Hz) .....	28
Model 5H (100/120 Volts - 50/60 Hz) .....	29
Model 51 (100/120 Volts - 50/60 Hz) .....	30
Model 51H (100/120 Volts - 50/60 Hz) .....	31
Model 10 (100/120 Volts - 50/60 Hz) .....	32
Model 10H (100/120 Volts - 50/60 Hz) .....	33
Model 101 (100/120 Volts - 50/60 Hz) .....	34
Model 101H (100/120 Volts - 50/60 Hz) .....	35

PART 4

ILLUSTRATIONS, FIGURES AND SCHEMATICS

FIG. NO.	PAGE
1. CONTROL PANEL .....	36
2. CONTROLLER BOARD REMOVAL .....	36
3. POWER CIRCUIT BOARD .....	37
4. DOOR HEATER & ATTACHING PARTS .....	37
5. TOP COVER REMOVED .....	38
6. REAR VIEW - COVER REMOVED .....	38
7. FAN MOTOR PLATE .....	39
8. I/R INTERFACE BOARD AND RELATED COMPONENTS .....	39
9. SHELF SLIDE REMOVAL .....	40
10. BLOWER DUCT REMOVAL .....	40
11. SHELF SLIDE .....	41
12. TOP COVER REMOVAL .....	41
13. DUAL CHAMBER UNITS - FILL/SIPHON PORT COVER REMOVAL .....	42
14. LOWER DOOR SUPPORT .....	42
15. UPPER DOOR SUPPORT BRACKET .....	43
WIRING DIAGRAMS & SCHEMATICS .....	44
U.S. CUSTOMER SUPPORT CENTERS .....	45

## PART 1

### DESCRIPTION OF SYSTEM OPERATION TROUBLESHOOTING TEST PROCEDURES

#### INTRODUCTION

This manual covers the maintenance and servicing of the Model 5, 10, 51, and 101 series of Fisher automatic CO<sub>2</sub> water jacketed incubators.

#### NOTE

*FOR THE REMAINDER OF THIS MANUAL,  
AND TO SIMPLIFY UNIT DESIGNATIONS,  
FISHER CATALOG NUMBERS WILL BE  
REFERRED TO BY THE FOLLOWING MODEL  
NUMBERS:*

<u>Catalog Number:</u>	<u>Model Number:</u>	<u>Description:</u>
116875	5	Single Chamber, T/C CO <sub>2</sub>
116875H	5H	Single Chamber, T/C CO <sub>2</sub> , RH
1168751	51	Single Chamber, I/R CO <sub>2</sub>
1168751H	51H	Single Chamber, I/R CO <sub>2</sub> , RH
1168710	10	Double Chamber, T/C CO <sub>2</sub>
1168710H	10H	Double Chamber, T/C CO <sub>2</sub> , RH
11687101	101	Double Chamber, I/R CO <sub>2</sub>
11687101H	101H	Double Chamber, I/R CO <sub>2</sub> , RH

This manual is divided into 4 basic parts. Part One (1) deals with the description of system operation, troubleshooting and calibration of the system. Part Two (2) deals with test procedures. Part Three (3) deals with removal/replacement procedures, and replacement parts lists. Part Four (4) offers illustrations, figures, and schematics for troubleshooting the incubator. It also offers a list of Fisher Scientific customer support centers and phone numbers.

#### 1.1 DESCRIPTION OF SYSTEM OPERATION

The FISHER incubators described herein incorporate microprocessor based control systems in a modular chassis design. All parameters for each chamber can be entered independently through the set point switches on

each door mounted controller. The incubator is completely automatic, easy to maintain and service in your laboratory. The following is a description of the system and how it operates.

The control systems are housed in each door, with signal conditioning and processing sent to a power board at the rear of the incubator. Most troubleshooting procedures for this system can be carried out with the rear covers removed and the controller pulled to the "Service Position." All electrical wires are identified and referenced to terminal connections in accordance with the schematic diagrams. All components and tubing connections can also be examined. The shelves, shelf support panels, and blower ducts are easy to removed from the chambers for cleaning. With these assemblies removed, the chamber walls can be cleaned without interference. There are no hard-to-clean areas.

Each water-jacket chamber is manufactured individually and mounted into the incubator chassis, allowing easy removal and replacement of a damaged chamber. The chamber modules have been conveniently fitted with a combination fill/siphon port so the water jackets can be filled or emptied with the same hose connection. The water in the jacket maintains a constant temperature source surrounding the chamber, enhancing the incubator's ability to provide a uniform temperature throughout the chamber.

All environmental parameters in the incubator's chambers are monitored and regulated by microprocessor-based electronic controls. All sensors are located on the motor plate of each individual chamber, as are the gas injection ports, and air heaters. The close proximity of the sensors to the control devices permits the system to maintain precise control over the chamber environment and efficient recovery of the environment after the door is opened.

Temperature control is achieved by means of a temperature sensor located on the motor plate, which monitors the chamber temperature. The primary control circuits provide proportional control



to the heaters, thereby eliminating temperature overshoot. A safety temperature control also monitors the chamber temperature through the primary temperature sensor. In the unlikely event the primary temperature control circuit fails, and tries to heat the chamber continuously, the safety temperature control will remove power from the chamber heaters, thus eliminating a run away temperature condition. When set properly, the safety temperature control can easily limit the maximum chamber temperature to within + 1.0°C of the set point entered with the primary control.

The unit is equipped with heated exterior doors which remove a majority of the condensation from the inner glass doors. This feature enables laboratory personnel to make a visual check of the incubator's contents without disturbing the incubator atmosphere. The door heaters are controlled by the same circuitry that controls the chamber heaters.

There are four (4) heaters for each chamber, consisting of two cartridge heaters located in the bottom of the water jacket, directly heating the water, one auxiliary heater located on the exterior top of the chamber, to eliminate ceiling condensation, and one air heater mounted to the fan motor plate. The air heater extends into the area enclosed by the fan blower duct at the rear of each chamber, which heats the atmosphere within the chamber. The circulating fan draws air in from the bottom of the chamber, moves the air across the air heater and up the blower duct, and then re-enters the chamber at the top.

The CO<sub>2</sub> percentage in each chamber is maintained independently by the electronic controls and either a thermo-conductivity type CO<sub>2</sub> sensor (Model 5H or 10H), or an Infra-Red type CO<sub>2</sub> sensor (Model 51H or 101H). The different types of CO<sub>2</sub> sensors are explained below.

The thermo-conductivity type CO<sub>2</sub> sensor (Model 5H or 10H) consists of a matched set of thermistor beads operating at an elevated temperature. One side of the sensor (reference section) is hermetically sealed, and senses only the chamber temperature. The other side is exposed to both chamber temperature and atmosphere.

When CO<sub>2</sub> is introduced into the chamber, the CO<sub>2</sub> has an insulating effect on the exposed section of the sensor. This causes the exposed thermistor temperature to increase, causing a voltage imbalance between the reference and sensing sections, which is compared by the analog circuitry. If the CO<sub>2</sub> level sensed is below set point, the control circuit will proportionally control the CO<sub>2</sub> solenoid valve, and meter small amounts of CO<sub>2</sub> into the chamber, as required. Proportional control accounts for less deviation in the amount of CO<sub>2</sub> fluctuation within the chamber.

Normally, CO<sub>2</sub> levels are affected by changes in relative humidity, when using a thermal-conductivity type CO<sub>2</sub> sensor. Care must be taken to avoid wide changes in operating relative humidity levels, in order to maintain good CO<sub>2</sub> control accuracy. Re-calibration of the CO<sub>2</sub> control will be necessary when changing to a different operating relative humidity.

The Infra-Red (I/R) type of CO<sub>2</sub> sensor (Model 51H or 101H) works on the principle of detecting the amount of I/R energy absorbed by the CO<sub>2</sub>. An I/R source is energized at predetermined intervals. This source is passed through a special filter (lens) and then passed on to an I/R detector. The amount of I/R energy is measured by the analog circuitry.

When CO<sub>2</sub> is introduced into the chamber, some of this CO<sub>2</sub> gas is passed through the optimal path inside the CO<sub>2</sub> sensor. As the CO<sub>2</sub> level increases, the amount of I/R energy absorbed increases. This amount of energy is measured and compared by the analog circuitry. If the CO<sub>2</sub> level is below set point, the control circuit will proportionally control the CO<sub>2</sub> solenoid valve as before. The I/R CO<sub>2</sub> sensor is not significantly affected by changes in operating relative humidity.

Relative humidity is measured by using a solid-state type humidity sensor mounted on the motor plate. The sensor monitors the relative humidity level within the chamber, which in turn is displayed on the front panel. It will monitor conditions from ambient to 99.0% relative humidity. The "tenths" digit is always fixed at "0".

Relative humidity is provided by pouring distilled water directly into a tray, which can be placed on a shelf or, if desired, by pouring the water directly onto the chamber floor. Pouring the water onto the floor will help maintain the highest relative humidity obtainable. However, this water should not be placed directly on the chamber floor when active chemicals to reduce fungus and mold growth are involved.

These units are also equipped with a temperature recorder jack and a provision for connection to a central monitoring system. The temperature recorder jack allows the user to monitor each incubator operating temperature independently,

by connecting a voltage type chart recorder to this jack. In this way complete temperature documentation can be provided along with the experiment or project. The output to the recorder is 10 mv/°C. This output does not monitor CO<sub>2</sub>.

The 1/4" phone jack, provided next to the recorder jack, can be used to connect the incubator to a central monitoring system. The jack can be wired either as "Normally Closed" or "Normally Open". There are "Form C" contacts used for the output of this jack. Alarm conditions that will activate this jack are High Temperature, Low or High CO<sub>2</sub> concentrations, and a safety set point adjusted below the desired operating set point.

## 1.2 TROUBLESHOOTING THE INCUBATOR SYSTEM

1. Too much condensation on glass door
  1. Door heater faulty; see Section 2.6
  2. Low or no voltage: check connections and wiring to Power circuit board; see Section 2.3
  3. Fan motor defective; see Section 2.8
  
2. CO<sub>2</sub> not regulating
  1. Check if CO<sub>2</sub> supply tank is empty
  2. Check CO<sub>2</sub> tubing for leaks, kinks, bends, or bad connections.
  3. Check CO<sub>2</sub> solenoid; see Section 2.9
  4. Defective Controller board; see Section 2.4
  5. + 7.35 volt supply not adjusted properly; see Section 2.13
  6. Fuse on I/R interface board defective; see Section 2.13
  7. CO<sub>2</sub> sensor defective; see Section 2.12, 2.13
  8. Fan motor defective; see Section 2.8
  
3. Displays not lighted
  1. Power circuit board not adjusted properly or defective power circuit board; see Section 2.3
  2. Power circuit board fuse blown; see Sections 2.2 & 2.3
  3. Transformer defective; see Section 2.2
  
4. Displays show random data
  1. Power circuit board not adjusted properly or defective power circuit board; see Section 2.3
  2. Defective controller board; see Section 2.4
  
5. No DC power.
  1. Check fuse F-1 on Power circuit board; see Section 2.3
  2. Check if there is AC power to the AC input terminals of the power circuit board. If not, check EMI filter fuses; see Section 2.1.
  3. Power circuit board defective; see Section 2.3
  4. Transformer defective; see Section 2.2.
  
6. DC voltages below normal.
  1. Disconnect J-10 from power circuit board to see if Controller board is loading the power supply.
  2. Power circuit board calibration; see Section 2.3.

- |  |   |
|--|---|
| 6. DC voltages below normal.   | <ol style="list-style-type: none"> <li>1. Disconnect J-10 from power circuit board to see if Controller board is loading the power supply.</li> <li>2. Power circuit board calibration; see Section 2.3.</li> </ol>   |
| 7. No AC power.  | <ol style="list-style-type: none"> <li>1. Defective AC power switch in EMI filter; see Section 2.1.</li> <li>2. Fuse blown in EMI filter; see Section 2.1.</li> <li>3. Defective power cord.</li> </ol>   |
| 8. Temperature above set point and "Hi" temp. indicator on.  | <ol style="list-style-type: none"> <li>1. Defective temperature sensor; see Section 2.11.</li> <li>2. Defective Controller board; see Section 2.4.</li> </ol>   |
| 9. Temperature in chamber not the same as that displayed.  | <ol style="list-style-type: none"> <li>1. Temperature calibration; see Section 1.3.</li> <li>2. Check temperature sensor connection.</li> <li>3. Temperature sensor defective; see Section 2.11.</li> <li>4. Fan motor defective; see Section 2.8.</li> </ol>   |
| 10. Temperature too low.   | <ol style="list-style-type: none"> <li>1. Safety temperature control set below temperature set point; see operator's manual.</li> <li>2. Heating element(s) defective; see Sections 2.5, 2.6 &amp; 2.7.</li> <li>3. Defective Power circuit board; see Section 2.3</li> <li>4. Fan motor defective; see Section 2.8.</li> <li>5. Temperature sensor defective; see Section 2.11.</li> </ol> |
| 11. Low water indicator LED on and chamber known to be full. Low water LED off and chamber known to be low on water. | <ol style="list-style-type: none"> <li>1. Float switch defective; see Section 2.10</li> </ol>   |
| 12. Relative humidity display indication too high (above 99.0%)  | <ol style="list-style-type: none"> <li>1. R.H. calibration; see Section 1.3.</li> <li>2. Defective R.H. sensor; see Section 2.14.</li> </ol>  |
| 13. Relative humidity display indication appears too low.  | <ol style="list-style-type: none"> <li>1. R.H. water supply depleted; see operator's manual.</li> <li>2. Defective door seals or fan motor plate gaskets; repair and replace as necessary.</li> <li>3. R.H. calibration; see Section 1.3.</li> </ol>  |

### 1.3 CALIBRATION

The calibration procedure is used to adjust the Temperature display, Safety Set Point and CO<sub>2</sub> parameters. Read this section carefully before attempting to calibrate the unit. Follow this procedure for the most accurate calibration. CO<sub>2</sub> must be calibrated last for best accuracy. It is assumed that the incubator is to be operating at 37.0°C. You can however operate at any desired temperature from 5°C above ambient to 50.0°C.

Prior to calibration, the CO<sub>2</sub> supply should be shut off. Be sure the CO<sub>2</sub> set point is set for "00.0". Place an accurate thermometer in the center of the chamber so it can be read with the glass door closed. Now the door must be CLOSED for a minimum of one (1) hour before performing the calibration procedure.

*IF THE INCUBATOR IS BEING OPERATED FOR THE FIRST TIME OR HAS BEEN OUT OF SERVICE FOR SOME TIME, THEN THE INCUBATOR TEMPERATURE MUST HAVE A CHANCE TO STABILIZE. WE RECOMMEND THE UNIT BE IN OPERATION FOR ABOUT 24 HOURS BEFORE ATTEMPTING CALIBRATION.*

#### 1.3.1 TEMPERATURE DISPLAY CALIBRATION

1. An accurate thermometer should have been placed in the center of the incubator chamber previously. Read the thermometer and compare it with the temperature display. If the display and the thermometer readings disagree, open the outer door and remove two (2) screws from the top of the control module. See Figure 1. Pull the control module up about three (3) inches until it locks in place, see Figure 2. On the right side of the control module are four (4) potentiometers. The top potentiometer (R-8) is used to adjust the temperature display. Adjust R-8 until the display agrees with the thermometer inside the chamber. Push the retainer in to release the control module. Slide the control module back into the door. Close the outer door.

2. Allow the incubator to stabilize for a minimum of one (1) hour and check the temperature readings. Recalibrate if necessary.

#### WARNING

**HANDLE MERCURY THERMOMETERS WITH THE UTMOST CARE. MINUTE AMOUNTS OF MERCURY IN THE INCUBATOR FROM A BROKEN THERMOMETER MAY CAUSE DAMAGE TO THE CHAMBER BY ELECTROLYSIS, AS WELL AS CREATING A TOXIC ENVIRONMENT WITHIN THE CHAMBER, RENDERING THE INCUBATOR USELESS.**

#### 1.3.2 SAFETY SET POINT CALIBRATION

When the "SAFETY SET PT." button is pressed, the "TEMP °C" window displays the set point of the back-up overtemperature control. Normally, this setting is between 0.5° and 1.0°C above the desired operating temperature (The desired operating temperature was determined when you selected the temperature with the set point switches.). This will allow the incubator to heat properly under normal conditions. In the unlikely event of a primary control failure, the back-up control acts as a guard to prevent the incubator chamber from overheating more than this set value. Proper calibration of the safety set point can not be overstressed.

From this you can also see that if the back-up overtemperature control is set below the desired operating temperature, the incubator will never heat. So if you decide to change the desired operating temperature, you must readjust the back-up overtemperature control.

If the overtemperature control set point is set equal to or less than the desired operating temperature, the "HI" temperature LED will flash, and the audible alarm will sound.

1. Press the "SAFETY SET PT." button. If the displayed reading is between 0.5° and 1.0°C above the desired operating temperature, then no further calibration of the back-up overtemperature control is needed.

2. If calibration is required, then open the outer door and pull the control module up about three (3) inches until it locks in place. See Figure 2. On the right side of the control module are four (4) potentiometers. The third potentiometer (R-10) is used to adjust the back-up control. While pressing the "SAFETY SET PT." button, adjust R-10 until the display reads between 0.5° and 1.0°C above the desired operating temperature. Push the retainer in to release the control module. Slide the control module back into the door before attempting to close the door.

### 1.3.3 RELATIVE HUMIDITY CALIBRATION

Normally the Relative Humidity Display will not require calibration. As a matter of fact, sophisticated equipment is required to verify calibration. Home type humidity gauges are not considered accurate. Their accuracy drops off dramatically in the upper humidity levels where the incubator normally operates.

1. Place an accurate humidity probe on the middle shelf of the incubator. Close the door and allow the unit to stabilize for a minimum of one (1) hour.
2. Compare the reading of your humidity instrument with the Relative Humidity Display. If the display and the humidity instrument

readings disagree, open the outer door and remove two (2) screws from the top of the control module. See Figure 1. Pull the control module up about three (3) inches until it locks in place. See Figure 2. On the right side of the control module are four (4) potentiometers. The bottom potentiometer (R-11) is used to adjust the R.H. display. Adjust R-11 until the display agrees with your humidity instrument. Push the retainer in to release the control module. Slide the control module back into the door and close the outer door.

### 1.3.4 CO<sub>2</sub> CALIBRATION

Now that the temperature controls have been calibrated properly, you will be finishing the calibration procedure by adjusting the CO<sub>2</sub>. Again, we will assume the doors have been closed a minimum of one (1) hour, and that the incubator is operating at the desired temperature and relative humidity. Remember, a tray of cool water placed in the chamber to provide humidity could take up to eight (8) hours before it reached the same temperature as the chamber. There should not be any CO<sub>2</sub> in the chamber, since the gas supply has not been turned on yet, and the CO<sub>2</sub> set point is set to "00.0".

#### NOTE

**MODELS 5, 5H, 10 AND 10H ARE SENSITIVE TO CHANGES IN OPERATING RELATIVE HUMIDITY. THESE UNITS MUST BE CALIBRATED AT THE DESIRED OPERATING RELATIVE HUMIDITY. KEEPING THE DOOR CLOSED A MINIMUM OF 1 HOUR WILL ASSURE THIS CONDITION.**

1. Open the outer door and pull the control module up about three (3) inches until it locks in place. See Figure 1. On the right side of the control module are four (4) potentiometers. The second potentiometer (R-9) is used to adjust the CO<sub>2</sub> display. Adjust R-9 until the display reads "00.0". This will "ZERO" the display. Push the retainer in to release the control module. Slide the control module back into the door and close the outer door.
2. Turn the CO<sub>2</sub> supply ON. Adjust the CO<sub>2</sub> line pressure between 15 and 25 PSI. (1.0-1.7 BAR.) Enter the desired CO<sub>2</sub> level with the CO<sub>2</sub> set point switches. Allow the unit to stabilize for a minimum of one (1) hour.
3. Take a gas sample, from the "Gas Sample Port" with CO<sub>2</sub> measuring instrument. The displayed reading and the actual reading from your CO<sub>2</sub> measuring instrument should agree. If not, open the outer door and pull the control module up and re-adjust potentiometer (R-9), until the two readings agree.
4. Push the retainer in to release the control module. Replace the two (2) control module screws and close the door.

#### 1.3.5 THERMOCONDUCTIVE CO<sub>2</sub> SENSORS

A thermoconductive (TC) CO<sub>2</sub> Sensor consists of exposed and sealed sensing sections. The sealed section of the sensor is isolated from ambient atmosphere and is not affected by changes in CO<sub>2</sub> concentration or relative humidity. This section is used as a reference level. The exposed section reacts with changes in CO<sub>2</sub> concentration, relative humidity and temperature. Any sudden change in any of those parameters will cause the sensor to rapidly react to the change. Increasing

humidity will cause the CO<sub>2</sub> display to fall. Conversely, if humidity decreases, the CO<sub>2</sub> display will rise. Also an increase or decrease in temperature will cause the display to rise or fall. When the gass door is opened, the rapid change in relative humidity may cause the CO<sub>2</sub> display to rise, contrary to what would be logical. The change is momentary and will stabilize quickly.

If you change the operating relative humidity level for any reason on Models 5H or 10H, re-calibration of the CO<sub>2</sub> control system is required. This is a natural physical phenomenon common to all thermo-Conductivity type CO<sub>2</sub> sensing systems. Most users do not change their operating relative humidity, so this is not normally a concern. The basic principle behind obtaining a different operating relative humidity is based on the amount of surface area of water provided by the humidity tray or dish. There are other factors such as the integrity of the chamber seals, etc. Under stable temperature and relative humidity conditions, FISHER's thermo-conductivity type CO<sub>2</sub> sensing systems rival Infra-Red type CO<sub>2</sub> sensing systems, when comparing control accuracy.

Users with the desire or need to change their operating relative humidity frequently or for those who open and close the inner door many times on a daily basis (which tends to lower the average relative humidity within the chamber) will benefit the most from the Infra-Red type CO<sub>2</sub> sensing system models (Models 51, 51H, 101 and 101H). Infra-Red CO<sub>2</sub> sensing systems are not adversely affected by wide changes in relative humidity.

#### 1.3.6 GAS SAMPLES

Gas samples are taken with a suitable sampling instrument ("Bacharach Fyrite" or Blood Gas Analyzer for example) through the gas sample ports.

## Part 2

### TEST PROCEDURES

#### NOTE

**VOLTAGE AND RESISTANCE MEASUREMENTS ARE TAKEN ACROSS THE PART UNDER TEST. ALWAYS REMOVE POWER CORD FROM ELECTRICAL OUTLET WHEN REMOVING A WIRE FOR TESTS. NEVER MAKE A RESISTANCE CONTINUITY MEASUREMENT WHILE UNIT IS PLUGGED INTO ELECTRICAL OUTLET. REFER TO ENCLOSED SCHEMATICS AND ILLUSTRATIONS TO AID IN TESTS.**

#### 2.1 POWER SWITCH/EMI FILTER

1. Turn on power switch, located on left side of unit, next to the power cord.
2. Check voltage across the EMI filter where the black and white wires are connected. See Figure 6.
3. If no power is indicated at the above connection, disconnect the power cord and check the fuses inside the EMI filter. This is accomplished by prying the cover off the fuse holder section of the EMI filter. The cover is located beneath the power switch. The fuses can be visually checked or checked with an ohmmeter on the low resistance scale. The resistance should be less than 0.2 ohm. When replacing the fuse holder, be sure the fuse holder orientation coincides with the electrical configuration of your unit. This is accomplished by aligning the arrows on the fuse holder for the proper voltage.

#### WARNING

**CHANGING THE FUSE HOLDER VOLTAGE CONFIGURATION DOES NOT CHANGE THE OPERATING VOLTAGE OF THE UNIT. DO NOT ATTEMPT TO USE THIS FOR THAT PURPOSE. THE UNIT OPERATING VOLTAGE IS CONFIGURED AT THE FACTORY AT THE TIME OF ASSEMBLY.**

4. Connect the power cord to the EMI filter, and turn on the power switch. If voltage is still not present, and the fuses are known to be good, replace the EMI filter.
5. If the fuses continue to open, remove the black and white wires from the EMI filter. Check the voltage at this connection again. If voltage is now present there is a short circuit in the unit. (A short circuit would cause the fuse(s) to continually open. This is why no voltage was present when the black and white wires were connected to the EMI filter.)
6. To isolate a short circuit, reconnect the wires to the EMI filter (after removing power to unit). Remove Connectors J-3, J-4, and the wires from Connector J-5 from the power circuit board, one at a time.
7. Turn the power switch to the ON position. When the fuse(s) stop opening, you have isolated the short circuit. If the fuse(s) stop opening after removing connector J-3, look for a defective water jacket heater or door heater. If they stop after removing J-4, look for a defective fan motor, or air heater. If they stop after removing the wires from J-5, look for a defective auxiliary heater. Leave voltmeter connected across EMI filter to monitor voltage.



8. If the short circuit is still not isolated, remove Connector J-2 from the circuit board. If the fuse(s) stop opening, the short circuit is on the power circuit board.

## 2.2 TRANSFORMER

The transformer located above the power circuit board provides isolated power for the secondary components. See Figures 3 and 6. The primary of the transformer is multi-taped to allow an input of 120 Volts. The secondary is a center-tapped design providing an isolated UL Class 2 rating of 9.5 Volts to the power circuit board. The 3/8 Ampere fuse (F-1) soldered to the power circuit board protects the transformer primary.

1. If there isn't any power to the controller, check the power circuit board fuse. If it is open, replace the fuse with the same type and rating. See Figure 3.
2. If the fuse continues to open, the transformer may either be shorted, or a secondary component may be shorted. To isolate the transformer from the secondary components, remove the secondary wires from Connector J-1. This will be two (2) red wires and one (1) red/yellow wire on the right end of Connector J-1. See Figure 3.
3. If the fuse continues to open, replace the transformer. Refer to Section 3.19 for transformer replacement.

## 2.3 POWER PRINTED CIRCUIT BOARD

The power printed circuit board is located on the back of the unit behind the rear cover. The power circuit board interfaces with the controller board, as well as the CO<sub>2</sub> sensor and solenoid valve, temperature sensor, and heaters. All power enters the power circuit board, which in turn powers or controls all other components on the unit.

Refer to Figure 3. Connector J-1 is the transformer connector. Pins 1 through 3 are the secondary terminals, Pin 2 being the center tap and Pin 6 for 120 Volts. Pin 8 is the common terminal.

Connector J-2 is the primary power input to the circuit board, Pin 1 being ground, Pin 2 is the common, and Pin 3 as the primary or "Hot" connection.

Connector J-3 supplies controlled output to the water jacket cartridge heaters and door heater. Pins 1 & 2 supply the left cartridge heater, Pins 3 & 4 supply the right cartridge heater. Pins 5, 6, 7 & 8 supply the door heater, with Pin 8 being ground. The connections are configured using the two voltage select jumpers located above Connector J-3.

Connector J-4 supplies controlled output to the air heater through Pins 5 & 6. J-4 also supplies power to the fan motor through Pins 4, 7 & 8, with Pin 4 being ground for the fan motor plate. Pins 1, 2 & 3 are generally not used except for an optional electrical outlet located inside the chamber.

Connector J-5 is the last AC connector. It is used for connection of the auxiliary chamber heater. Pin 1 is common.

Connector J-6 is actually a pair of wires that are soldered in place which supplies 5 volts DC to the CO<sub>2</sub> solenoid valve. Pin 1 is the positive (+) terminal, Pin 2 is the negative (-) terminal. The solenoid valve itself however, is not polarity dependent.

Connector J-7 connects the water jacket float level switch into the circuit. The float switch is connected in series with an LED on the controller board through the power circuit board to give an indication of the water level in the water jacket.

Connector J-8 is used for interfacing the Infra-Red (I/R) type CO<sub>2</sub> sensor circuitry used on Model 51H or 101H. An interface board is connected here. Pin 1 is the unregulated DC source of the interface board. Pin 2 is ground. Pin 3 is the output from the I/R CO<sub>2</sub> sensor, Pin 4 is analog ground. Pin 5 is used for the shield. When the I/R type CO<sub>2</sub> sensor is used, the jumper located between components R-1 and C-3 must be configured for the "I/R" position.

Connector J-9 is a 20-pin connector that connects the controller to the power circuit board. The following table shows the pin designations.

### CONNECTOR J-9 PIN DESIGNATIONS

PIN NUMBER	PIN DESIGNATION
1	+5 VDC Digital Source
2	Digital Ground
3	+5 VDC Digital Source
4	Digital Ground
5	Solid State Relay (Triac)
6	Solenoid Valve
7	Safety Relay
8	Alarm Relay
9	Digital Ground
10	Float Switch
11	I/R CO <sub>2</sub>
12	Sensing (Relative Humidity)
13	Analog Ground
14	Sensing (T/C CO <sub>2</sub> )
15	Analog Ground
16	Reference (T/C CO <sub>2</sub> )
17	Analog Ground
18	Temperature
19	Analog Ground
20	Unregulated DC

Connector J-10 is used for connection to the solid state temperature sensor. Pin 1 is the +5 VDC source, Pin 2 is the output from the temperature sensor, Pin 3 is analog ground.

Connector J-11 is used to connect therm conductivity (T/C) type CO<sub>2</sub> sensor to the power circuit board. The T/C type CO<sub>2</sub> sensor is used on Model 5H or 10H. Pin 1 is the sensing connection, Pin 2 is analog ground, Pin 3 is the reference connection. When the T/C type CO<sub>2</sub> sensor is used, the jumper located between components R-1 and C-3 must be configured for the "T/C" position. See Figure 3.

Connector J-12 is an optional output for connection to a temperature recorder for the sole purpose of monitoring the chamber temperature. The output is 10 mv/°C. The tip connection is positive (+). The mating plug can be purchased

through many electronic supply stores. The plug is manufactured by Switchcraft. (Switchcraft P/N 850.)

Connector J-13 is also an optional connection for monitoring the incubator through a central monitoring system. Any alarm condition will activate relay K-2, thereby alerting the central monitor. J-13 is a 3-conductor jack. This enables configuration either as "NORMALLY CLOSED" or "NORMALLY OPEN" as required by the monitoring system. The case of J-13 is ground. The tip connection is "NORMALLY CLOSED". Again the mating plug can be purchased through many electronic supply stores. The plug is manufactured by Switchcraft. (Switchcraft P/N 260.)

Connector J-14 is used for connection to the relative humidity sensor. Pin 1 is the unregulated DC source, Pin 2 is the output from the relative humidity sensor, Pin 3 is analog ground.

### 2.3.1 POWER BOARD CALIBRATION

Normally the power circuit board is calibrated at the factory. If however you find that the calibration is not correct, follow these steps for proper calibration.

1. Disconnect electrical service from unit.
2. Disconnect harness Connectors J-9 and J-10 from the power circuit board. See Figure 3.
3. TC/IR Jumper must be in the TC position for calibration purposes. On Models 51, 51H, 101 and 101H, reset jumper to IR position after calibration and checking (Step 7) are complete.
4. Attach a voltmeter across Pins 1 & 3 (-) on Connector J-10.
5. Connect electrical service to unit. Adjust R-10 for an output of +5.1 volts. The accuracy of this calibration is critical.
6. Next, remove the test lead from Pin 1 and attach it to the junction of R-2/R-3 (right side of R-2/R-3). See Figure 3. This junction is

located near capacitor C-5. Leave the other test lead attached to Pin 3 on Connector J-10.

7. Adjust R-9 for an output of +7.35 volts. Again, the accuracy of this calibration is critical.
8. Disconnect the power to the unit. Reconnect harness connectors J-9 & J-10 to the power circuit board. Apply power to the unit, and recheck the calibration. Adjust as necessary.
9. If the above conditions cannot be met, replace the power circuit board. Refer to Section 3.18 for power circuit board replacement.

## 2.4 CONTROLLER CIRCUIT BOARD

The controller assembly located in the door consists of two (2) boards, the digital display board, and the CPU board. These boards contain the digital displays, set point switches, alarm indicating and regulating LED's. The controller also houses the safety set point and silence switches. The controller incorporates an Intel 8051 series micro-controller with a 27C256 EPROM. Since the controller uses mechanical switches for setting temperature and CO<sub>2</sub> parameters, a battery back-up for memory retention is not required.

The edge connector fingers are designated the same as Connector J-9 on the power circuit board. See Figures 1 & 3. The even numbered fingers are located on the front side of the board, the odd numbered fingers are on the back side.

Jumper JP-1, also located above U-2 selects the configuration for the type of CO<sub>2</sub> sensing system that is used. JP-2 would be set for the "OUT" position for T/C units. Models 51, 51H, 101 and 101H use the Infra-Red (I/R) CO<sub>2</sub> sensor. This jumper must be set properly for your type of CO<sub>2</sub> sensor.

Jumper JP-3, located to the left of U-2 configures the relative humidity sensor to be in circuit on these models. This jumper should always be set for the "OUT" position.

If a valid set point is not entered, the controller will not allow the unit to heat, inject CO<sub>2</sub> or both. Valid set points for temperature control are 0.1 to 50.0°C. Valid set points for CO<sub>2</sub> control are 0.1 to 20.0%. Naturally a set point of 0.0 for either temperature or CO<sub>2</sub> turns off that function.

The only calibration required in the field is adjusting the temperature display, safety set point and CO<sub>2</sub>. These procedures are described in Section 1.3. **Do not attempt to adjust potentiometers R-15, R-16, R-17, or R-18.** If other problems are suspected with the board, it is highly recommended you contact your local Fisher Scientific representative for service suggestions. The controller board is designed for easy removal and replacement. Refer to Section 3.17 for controller board assembly replacement.

## 2.5 CHAMBER HEATER

There are four (4) heaters for each chamber, consisting of two (2) cartridge heaters located in the bottom of the water jacket, directly heating the water, one (1) auxiliary chamber heater located on the top of the water jacket (refer to Section 2.7), and one (1) air heater mounted to the fan motor plate, which heats the atmosphere within the chamber. The air heater is protected with a limiting thermostat, which is mounted to the fan motor plate. All heaters are rated at 100 watts each, with the exception of the auxiliary chamber heater, its rating being 50 watts. This yields a total of 350 watts heat capacity.

To test the cartridge heaters:

1. Disconnect electrical service from unit.
2. To provide access to cartridge heaters, remove the rear cover which exposes the power circuit board. See Figure 6.
3. Remove Connector J-3 from the power circuit board. See Figure 3. With an ohmmeter, measure at connector J-3, between Terminals 1 and 2, then Terminals 3 and 4. The following resistance values should be met:

120 volt heaters: 140 ohms + 10% (cold resistance).

4. With Connector J-3 still removed from the power circuit board, measure resistance from heating element case to one of its wires. Select highest range on ohmmeter. Do not touch test leads with hand. Meter should read infinity.

Any reading less than infinity indicates cartridge heater is shorting to ground. Replace faulty cartridge heater. Refer to Section 3.8 for cartridge heater replacement.

To test the air heater(s):

5. Disconnect the wires at the air heater terminals. See Figure 6. Measure the resistance across air heater terminals. Readings should be the same as for the cartridge heaters shown above.
6. Next measure between heater sheath and heater terminals. Meter should read infinity.
7. If heater does not meet the above specifications, replace air heater. Refer to Section 3.9 for air heater replacement.

## 2.6 DOOR HEATER

There is a door heater inside each door, attached to the door liner. See Figure 4. Each heater has two sections. Each section is rated at approximately 40 watts. This yields approximately 80 watts per door. The door heater is controlled by the chamber heater circuit. When the chamber heaters are on, the door heater is on. The door heater eliminates a majority of the moisture on the glass door. The heaters are connected in a parallel connection for 120 volt operation.

To test the door heater:

1. Remove Connector J-3 from the power circuit board. See Figure 3. Measure at Connector J-3, Terminals 5 and 6, then at Terminals 6 and 7. The following cold resistance values should be met:

120 volt operation: 320 ohms, -10 + 0% (cold resistance).

2. If the above values are not met, replace the door heater. Refer to Section 3.10 for door heater replacement.

## 2.7 AUXILIARY CHAMBER HEATER

The auxiliary chamber heater provides 50 watts of heat to the top front edge of the chamber. See Figure 5. This reduces the possibility of condensation forming on the ceiling of the chamber when operating at elevated relative humidity.

This heater is provided with a limiting thermostat to limit the maximum temperature the heater can obtain. The limiting thermostat is built into the heater.

To test the auxiliary heater:

1. Disconnect electrical service from unit.
2. Remove the 2 wires from Connector J-5 at the power circuit board. See Figure 3.
3. Measure the resistance across these 2 wires. The following values should be met:  
120 volt operation: 280 ohms, +10% (cold resistance).
4. If you initially obtain a reading of infinity (open), and the unit is warm, wait a few moments in case the limiting thermostat has opened. If, after a few moments the above values are not met, replace the auxiliary chamber heater. Refer to Section 3.11 for instructions on auxiliary chamber heater replacement.

## 2.8 FAN MOTOR

The fan motor provides circulation of the chamber atmosphere. Refer to Figures 6 & 7 in the illustration section of this manual. The motor is an induction type AC motor, running at line voltage. The rotation of the motor is counterclockwise as viewed from the rear of the incubator.

The circulation of the atmosphere is vital for proper operation of the Incubator. Without proper circulation, poor control of the environment may be experienced, relating to problems with temperature and CO<sub>2</sub> regulation.

The motor requires no servicing, as it uses permanently lubricated ball bearings.

There is a metal plate which is used as an interference shield. The metal plate is located between the fan motor and the I/R CO<sub>2</sub> sensor. This shield is used to prevent electrical or magnetic interference from affecting the I/R type CO<sub>2</sub> sensor found on Models 51, 51H, 101 and 101H. This plate and any attached grounding conductors is vital to proper operation of the unit. It is not used with the T/C type CO<sub>2</sub> sensor found on Models 5H and 10H.

1. If a fan motor fails to operate, try turning the motor shaft. If it is binding, check and make sure the blower wheel is not forced onto the motor shaft too far, or that it is binding against the blower duct. If the blower duct is removed for any reason, be sure the spacer is installed on the long stud before re-installing. See Figure 7. This will keep the wing nut from being over-tightened and causing the blower duct to bend and stop the blower wheel.
2. You should also check for line voltage at connector J-4 Terminals 7 and 8 on the power circuit board. If voltage is present, disconnect motor and check continuity of coil. If coil is open, replace motor. Refer to Section 3.7 for fan motor replacement.

### 2.9 CO<sub>2</sub> SOLENOID VALVE

The CO<sub>2</sub> solenoid valve is of the normally closed configuration. It is mounted at the lower left edge of the power circuit board. Refer to Figure 6 in the Illustration Section of this manual. It is important to maintain a minimum of 20 PSI (1.5 BAR) pressure to maintain the proper flow of CO<sub>2</sub> to the chamber. 5 Volts DC applied to the coil activates (opens) the solenoid valve. The signal is supplied through the power circuit board.

To test the CO<sub>2</sub> valve:

1. Set the CO<sub>2</sub> set point to 20.0%. The green "REG" LED for CO<sub>2</sub> should be on. The valve should be energized at this time. The valve makes an audible click (although not very loud), when energized. Monitor the voltage at the solenoid coil.
2. If the valve does not energize, disconnect both wires at the coil and measure the resistance. The resistance should be approximately 53 ohms + 10%. If not, replace solenoid valve. Refer to Section 3.2 for solenoid valve replacement.
3. When the valve is closed, there should not be any CO<sub>2</sub> flowing. The valve should be "Bubble Tight". Test this condition by placing the end of the CO<sub>2</sub> injection tubing in a beaker of water. There should be no bubbles. Replace solenoid valve if found faulty. Refer to Section 3.2 for solenoid valve replacement.

### 2.10 FLOAT SWITCH

The float switch monitors the water level of the water jacket. See Figure 5. When the water level drops a sufficient amount, the float switch contacts close, and allows the "LOW WATER" indicator to illuminate.

To test the float switch for a low water condition:

1. Siphon a sufficient amount of water through the water fill/siphon port. (About three liters or less should be sufficient). The "LOW WATER" indicator should illuminate. If not, siphon another four liters of water. If the "LOW WATER" indicator still does not illuminate, replace the float switch.

To test the float switch for a high water condition:

2. Add three liters of water to the siphon/fill port. The indicator should turn off. If not, add another four liters of water. Add this water slowly, for if the unit is overfilled, the excess water will run out the vent tube on the upper face of the chamber. See Figure 4.

3. If the "LOW WATER" indicator does not turn off, the float switch should be replaced. Refer to Section 3.12 for float switch replacement.

## 2.11 TEMPERATURE SENSOR

The temperature sensor is a solid-state device operating on + 5.0 volts DC. The input to the sensor can be measured at Connector J-10 Pins 1 & 3 on the power circuit board. See Figures 3 & 6.

The output of the sensor is measured between Pins 2 & 3. The output should be about 10 mv/°C. In theory if a thermometer reading in the center of the chamber reads 37.0 degrees. The voltage at Pins 2 & 3 should be about 370 millivolts. You will probably find the output of the sensor slightly higher than this due to the slightly elevated temperature of the fan motor plate.

If the above conditions are not met, then replace the temperature sensor. Refer to Section 3.5 for temperature sensor replacement.

## 2.12 T/C CO<sub>2</sub> SENSOR

The T/C CO<sub>2</sub> sensor is a matched set of thermistor beads operating at an elevated temperature. See Figures 3 & 6. One side of the sensor (reference section) is hermetically sealed, and senses only the chamber temperature. The other side is exposed to both chamber temperature and atmosphere. The exposed section reacts with changes to CO<sub>2</sub> concentration, relative humidity and temperature. Any sudden change in any of those parameters will cause the sensor to rapidly react to the change.

Increasing humidity will cause the CO<sub>2</sub> display to fall. Conversely, if humidity decreases, the CO<sub>2</sub> display will rise. Also an increase or decrease in temperature will cause the display to rise or fall. When the glass door is opened, the rapid change in relative humidity may cause the CO<sub>2</sub> display to rise, contrary to what would be logical. The change is momentary and will stabilize quickly.

When CO<sub>2</sub> is introduced into the chamber. The CO<sub>2</sub> has an insulating effect on the exposed section of the sensor. This causes the exposed thermistor temperature to increase, causing a

voltage imbalance between the reference and sensing sections. Which is compared by the analog circuitry.

## 2.13 I/R CO<sub>2</sub> SENSOR

The Infra-Red (I/R) type of CO<sub>2</sub> sensor works on the principle of detecting the amount of I/R energy absorbed by the CO<sub>2</sub>. An I/R source is energized at pre-determined intervals. This source is passed through a special filter (lens) and then passed on to an I/R detector. The amount of I/R energy is measured by the analog circuitry. See Figures 6 & 8.

When CO<sub>2</sub> is introduced into the chamber some of this CO<sub>2</sub> gas is passed through the optical path inside the CO<sub>2</sub> sensor. As the CO<sub>2</sub> level increases, the amount of I/R energy absorbed increases.

The I/R CO<sub>2</sub> sensor is not significantly affected by changes in operating relative humidity.

An interface board is used between the sensor and the power circuit board. See Figure 8. Note that the lower right mounting hole of the interface board must be isolated from chassis ground.

There is a metal shield surrounding the I/R CO<sub>2</sub> sensor which protects the sensor from electrical or magnetic interference generated by the fan motor. This shield must be in place for proper operation of the unit.

The small diameter tube leading out of the sensor must be kept plugged at all times for proper operation. See Figure 8. Any CO<sub>2</sub> that might enter through here will significantly upset the calibration of the unit.

1. If the sensor fails to operate, check the fuse of the I/R interface board. For other problems related to the I/R sensor, contact your local Fisher Scientific service representative. Refer to Section 3.4 for I/R CO<sub>2</sub> sensor replacement.

## 2.14 RELATIVE HUMIDITY SENSOR

The relative humidity sensor is a solid state device working on the principle of capacitance change for a change in relative humidity. The input voltage

is derived from the unregulated DC supply. The output voltage is 0-1.0 VDC, depending on the level of relative humidity being sensed. Refer to Figures 3 and 7.

The input voltage can be measured between Pins 1 and 3 on connector J-14 on the power board. Refer to Figure 3. The output voltage can be measured between Pins 2 and 3.

If the display reads 85.0% relative humidity, your voltage reading should be approximately 850 mV at Pins 2 and 3. Your actual voltage reading may be slightly lower due to the offset to compensate for the slightly higher temperature seen at the placement of the relative humidity sensor. This higher temperature tends to cause the average sensor reading to be slightly lower than the average relative humidity as measured within the working area of the chamber.

The output is directly proportional to the relative humidity being sensed. Remember this value is the raw sensor output, not the offset compensated reading as displayed on the front panel.

If the above values are not met, then replace the relative humidity sensor. Refer to Section 3.6 for relative humidity sensor replacement.

## PART 3

### REMOVAL/REPLACEMENT PROCEDURES

#### CAUTION

*BEFORE PERFORMING THE FOLLOWING REMOVAL/REPLACEMENT PROCEDURES DISCONNECT THE ELECTRICAL SERVICE FROM THE UNIT. SHUT THE GAS SUPPLIES OFF BEFORE SERVICING SOLENOID VALVES AND RELATED FITTINGS.*

#### 3.1 SHELF SUPPORTS & BLOWER DUCT

1. Remove contents from incubator shelves and remove shelves.
2. Turn power switch off.
3. Remove the shelf slides from the shelf support brackets. See Figure 9.
4. Remove the front shelf supports by lifting up on the shelf support so that the keyhole will clear the button at the top and bottom of each support. Pull the shelf support up off each button. See Figure 9.
5. Support the blower duct with one hand while removing the wingnut from the blower duct. Tilt the top of the blower duct towards the front of the chamber.
6. Remove the blower duct from the chamber. The blower duct must be turned to the left or right as it can not be removed by pulling it straight out. See Figure 10.
7. Install in the reverse order of above procedure. Be sure to reinstall the plastic spacer onto the long stud near the fan before replacing the blower duct. Failure to do so will cause the fan to stop turning by over-tightening of the wingnut.

#### 3.2 SOLENOID VALVES

1. Disconnect electrical service.

2. Remove the rear cover.
3. Disconnect the wires from the solenoid valve. Remove the tubing from the solenoid valve by turning the fittings 1/4 turn counterclockwise. Remove screw(s) from the solenoid valve bracket. Refer to Figure 3.
4. Remove the fittings from the old solenoid valve. Use an ample amount of thread sealant on the threads before installing the fittings into the new solenoid valve. Do not allow the thread sealant to enter the solenoid valve. It might cause the valve to malfunction. The fittings are also fragile. Do not apply excessive torque.
5. Replace the solenoid valve in the reverse of the above procedure.

#### 3.3 T/C CO<sub>2</sub> SENSOR

1. Disconnect electrical service.
2. Refer to Section 3. 1 on shelf support removal.
3. Remove 4 nuts from fan motor/sensor plate and pull the plate into chamber. Refer to Figure 7.
4. Disconnect the sensor from Connector J-11 at the power circuit board.
5. Remove 4 screws securing the CO<sub>2</sub> sensor assembly to fan motor/sensor plate.
6. Replace the CO<sub>2</sub> sensor in the reverse of the above procedure.

#### 3.4 I/R CO<sub>2</sub> SENSOR ASSEMBLY

1. Disconnect electrical service.
2. Remove the rear cover.
3. Disconnect the sensor from the interface board. Disconnect the 4 pin connector from the interface board. The I/R CO<sub>2</sub> sensor will



normally be replaced as an assembly which includes the interface board. See Figures 3 & 8.

4. Remove 4 screws securing the CO<sub>2</sub> sensor assembly to fan motor/sensor plate.
5. Remove 3 or 4 screws securing the interface board to the back of unit. See Figure 8.
6. Remove the sensor cable from the CO<sub>2</sub> sensor. Remove the metal shield from the CO<sub>2</sub> sensor and place on the new sensor. This shield must be in place for proper shielding from electrical or magnetic interference.
7. Replace the I/R CO<sub>2</sub> sensor assembly in the reverse of the above procedure.

**NOTE**

*IT IS IMPORTANT TO MECHANICALLY ISOLATE THE LOWER RIGHT MOUNTING SCREW OF THE INTERFACE BOARD FROM CHASSIS GROUND.*

**3.5 TEMPERATURE SENSOR**

1. Disconnect electrical service.
2. Refer to Section 3.1 on shelf support removal.
3. Remove 4 nuts from the fan motor/sensor plate and pull the plate in the chamber. See Figure 7.
4. Disconnect temperature sensor wires at Connector J-10 and remove sensor.
5. Replace temperature sensor in reverse of the above procedure.

**3.6 RELATIVE HUMIDITY SENSOR**

1. Disconnect electrical service.
2. Refer to Section 3.1 on shelf support removal.
3. Remove 4 nuts from the fan motor/sensor plate and pull the plate in the chamber. See Figure 7.

4. Disconnect temperature sensor wires at Connector J-10 and remove sensor.

5. Replace temperature sensor in reverse of the above procedure.

**3.7 FAN MOTOR**

1. Disconnect electrical service.
2. Refer to Section 3.1 on shelf supports & blower duct removal and remove these items.
3. Remove 4 nuts from the fan motor/sensor plate, and pull the plate into the chamber. See Figure 7.
4. Disconnect Connectors J-4, J-10 and J-11 from the Power board. Remove the fan motor wires from Connector J-4 Terminals 7 & 8.
5. Remove blower wheel from fan motor shaft.
6. Remove 2 screws from fan motor and remove fan motor. On models 51, 51H, 101 or 101H, remove the metal shield. This shield must be placed on the new motor for proper shielding of the I/R CO<sub>2</sub> sensor.
7. Replace fan motor in reverse of above procedure.

**NOTE**

*BE SURE MOTOR ROTATION IS CORRECT. ROTATION SHOULD BE COUNTERCLOCKWISE WHEN VIEWED FROM REAR OF INCUBATOR.*

**3.8 CARTRIDGE HEATERS**

1. Disconnect electrical service.
2. Remove rear cover.
3. Carefully remove heater wires from Connector J-3 at Power board. Refer to Figure 6.
4. Remove the nuts holding the heaters to the chamber.

5. Slide heating element(s) out from chamber. See Figure 6.
6. Replace cartridge heaters in reverse order of above procedure.

**CAUTION**

*RECONNECT HEATING ELEMENT WIRES EXACTLY AS REMOVED TO ASSURE PROPER OPERATION. IN CASE OF DIFFICULTY REFER TO THE ELECTRICAL WIRING DIAGRAM FOR THE PROPER HEATER WIRING ARRANGEMENT FOR YOUR ELECTRICAL SERVICE.*

**3.9 AIR HEATER**

1. Disconnect electrical service.
2. Refer to Section 3.1 on shelf supports & blower duct removal and remove these items.
3. Remove 4 nuts from the fan motor/sensor plate, and pull the plate into the chamber. See Figure 7.
4. Disconnect Connectors J-4, J-10, and J-11 from the Power board. Remove the fan motor plate from the chamber.
5. Disconnect heater wires at heater terminals. See Figure 6.
6. Remove two (2) nuts and washers from the heater posts, and remove heater from fan motor plate.
7. Replace air heater in reverse of the above procedure. Be sure heater is installed straight and parallel with chamber walls to avoid hot spots.

**3.10 DOOR HEATERS**

1. Disconnect electrical service.
2. Remove 6 screws which fasten door liner to door. Raise inner edge of gasket to gain access to screws. Do not remove screws completely from gasket; this will aid in reassembly because screw tips will hold location of holes in gasket. See Figure 4.
3. Remove door liner and at same time cut the 3 door heater wires about 8 inches above the lower door supports bracket. These wires will be used again.
4. Carefully peel door heater from door liner to avoid wrinkling door liner.
5. Remove paper backing from new door heater and apply adhesive side to liner in same position: with wires extending in same direction as faulty heater. Be sure all air pockets are removed when applying heater to door liner. This will prevent hot spots.
6. Cut the new heater wires to match the length of the original door heater wires. Connect one black wire from the new door heater to one of the original black wires with a wire nut. Repeat this for the other set of black wires with another wire nut. Finally connect the 2 white wires together with a wire nut.
7. Isolate the wire nut connections within the insulation.
8. Re-position wires and connectors and then replace all covers.

**3.11 AUXILIARY CHAMBER HEATER**

1. Disconnect electrical service.
2. Remove the screws from the top cover. Remove 2 screws from each end of the fill/siphon port cover. See Figure 12. Slide the top cover forward about 1/2 inch to release it from the front of the enclosure. Lift top up and disconnect the sample port tubing. Remove top from the unit.
3. For the lower chamber, remove 2 screws from each end of the lower fill/siphon port cover. See Figure 13. Grasp each end of the cover and push it down to release the front edge from the upper splash cover. Lift cover out and remove sample port tubing.
4. Remove the wire nuts from the heater wires. Carefully remove heater from top of chamber. Note the location for replacement purposes. See Figure 5.

5. Remove paper backing from new heater and apply adhesive side to chamber in same position: with wires extending in same direction as faulty heater. Be sure all air pockets are removed when applying new heater to top of chamber. This will over vent hot spots.
6. Connect the wires as before.
7. Replace all covers.

### 3.12 FLOAT SWITCHES

1. Disconnect electrical service.
2. For the upper chamber, remove the screws from the top cover. Remove 2 screws from each end of the fill/siphon port cover. See Figure 12. Slide the top cover forward about 1/2 inch to release it from the front of the enclosure. Lift top up and disconnect the sample port tubing. Remove top from the unit.
3. For the lower chamber, remove 2 screws from each end of the lower fill/siphon port cover. See Figure 13. Grasp each end of the cover and push it down to release the front edge from the upper splash cover. Lift cover out and remove sample port tubing.
4. Remove wire nuts from the float switch wires. With a thin flat blade screw driver or knife, carefully pry the float switch mounting bushing from the top of the chamber. Once the bushing has come loose, lift the float switch out from the top of the chamber. See Figure 5. Remove paper backing from the washer on the new float switch. Replace the float level switch in the reverse of the above procedure.

### 3.13 INNER GLASS DOOR

1. Remove the four (4) acorn nuts securing the two (2) glass door hinges to chamber face.
2. Remove the glass door.
3. Replace glass door in the reverse of the above procedure.

### 3.14 OUTER DOOR

#### CAUTION

*BEFORE ATTEMPTING TO REPLACE AN OUTER DOOR. READ THIS SECTION THOROUGHLY. BE SURE YOU HAVE THE PROPER TOOLS TO CRIMP A NEW CONNECTOR ON THE CONTROLLER CABLE. THE CONNECTOR IS A 20-CONDUCTOR DEVICE. THE CRIMPING TOOLS WILL BE MADE AVAILABLE WITH THE DOOR REPLACEMENT KIT.*

#### 3.14.1 SINGLE CHAMBER UNITS

1. Disconnect electrical service. Remove contents from incubator chamber. Remove the shelves. Drain water from water jacket. Refer to Section 3.17 on controller removal.
2. Remove rear cover. Disconnect Connector J-9 from Power board. Remove the controller cable ground wire from the ground stud. See Figures 3 & 6.
3. Remove the screws from the top cover. Remove 2 screws from each end of the fill/siphon port cover. See Figure 12. Slide the top cover forward about 1/2 inch to release it from the front of the enclosure. Lift top up and disconnect the sample port tubing. Remove top from unit.
4. Set the unit on its back. Use 3-inch thick support blocks to rest the unit on.
5. Cut the 4 heater wires (including ground) about 3 inches below the lower door support. These wires will be used again. See Figure 14.
6. Cut the controller cable near the upper door support bracket. Cut this wire only if you are replacing the door. Remove 4 nuts and bolts from the upper door support bracket. See Figure 15. Lift bracket and door off unit.
7. Route new controller cable through upper door support bracket. Route the door heater wires through the lower door support bracket.

8. Place the door and upper door support bracket back on the unit. Make sure door is square with unit. Attach the upper door support bracket and tighten securely.
  9. Cut the new door heater wires about 4 inches below the lower door support. Strip the ends about 3/8 inch. Connect one black wire from the new door heater to one of the original black wires with a wire nut. Repeat this for the other set of black wires with another wire nut. Connect the 2 white wires together with another wire nut. Finally attach the 2 ground wires together with a wire nut. Secure the wires from physical damage.
  10. Set the unit upright. There are adjustment points at the upper and lower door mounting brackets so that the outer door may be adjusted to close properly. The outer door gasket should contact the incubator body evenly on all four sides. If the door needs adjustment proceed as follows:
    - a. With a wrench, loosen the two nuts near the base of the lower door hinge. See Figure 14. Do not remove. This will allow adjustment of the lower section of the door. Adjust and tighten as necessary. Do not use excessive torque on these nuts.
    - b. Loosen the two nuts near the base of the upper door hinge. See Figure 15. This will allow adjustment of the upper section of the door. Adjust and tighten as necessary. Again, do not use excessive torque on these nuts.
  11. Securely attach the end of the new controller cable to the end of the old controller cable and pull the old cable out from the back of the unit until the new cable appears.
  12. Follow the instructions supplied with the door replacement kit for proper use of the installation tools for the 20 pin connector. Plug the connector back into J-9 on the Power board. Attach the ground wire to the ground stud.
  13. Replace the top cover being sure to RECONNECT the sample tube. Replace the rear cover. Replace the controller.
  14. Test the unit for normal control function.
- ### 3.14.2 DUAL CHAMBER UNITS/LOWER DOOR
1. Disconnect electrical service. Remove contents from incubator chambers. Remove the shelves. Drain water from water jackets. Refer to Section 3.17 on controller removal.
  2. Remove rear cover. Disconnect Connector J-9 from Power board. Remove the controller cable ground wire from the ground stud. See Figures 3 & 6.
  3. Remove 2 screws from each end of the lower fill/siphon port cover. See Figure 13. Grasp each end of the cover and push it down to release the front edge from the upper splash cover. Lift cover out and remove sample port tubing.
  4. Set the unit on it's back. Use 3-inch thick support blocks to rest the unit on.
  5. Cut the 4 heater wires (including ground) about 3 inches below the lower door support for the lower chamber. See Figure 14. These wires will be used again.
  6. Cut the controller cable near the upper door support bracket for the lower chamber. Cut this wire only if you are replacing the door. Remove 4 nuts and bolts from the upper door support bracket for the lower chamber. See Figure 13. Lift bracket and door off unit.
  7. Route new controller cable through upper door support bracket. Route the door heater wires through the lower door support bracket.
  8. Place the door and upper door support bracket back on the unit. Make sure door is square with unit. Attach the upper door support bracket and tighten securely.

9. Cut the new door heater wires about 4 inches below the lower door support. Strip the ends about 3/8 inch. Connect one black wire from the new door heater to one of the original black wires with a wire nut. Repeat this for the other set of black wires with another wire nut. Connect the 2 white wires together with another wire nut. Finally attach the 2 ground wires together with a wire nut. Secure the wires from physical damage.

10. Set the unit upright. There are adjustment points at the upper and lower door mounting brackets so that the outer door may be adjusted to close properly. The outer door gasket should contact the incubator body evenly on all four sides. If the door needs adjustment proceed as follows:

a. With a wrench, loosen the two nuts near the base of the lower door hinge. See Figure 14. Do not remove. This will allow adjustment of the lower section of the door. Adjust and tighten as necessary. Do not use excessive torque on these nuts.

b. Loosen the two nuts near the base of the upper door hinge. See Figure 15. This will allow adjustment of the upper section of the door. Adjust and tighten as necessary. Again, do not use excessive torque on these nuts.

11. Securely attach the end of the new controller cable to the end of the old controller cable and pull the old cable out from the back of the unit until the new cable appears.

12. Follow the instructions supplied with the door replacement kit for proper use of the installation tools for the 20 pin connector. Plug the connector back into J-9 on the Power board. Attach the ground wire to the ground stud.

13. Replace the lower fill/siphon port cover being sure to reconnect the sample tubing. Replace the rear cover. Replace the controller.

14. Test the unit for normal control function.

### 3.14.3 DUAL CHAMBER UNITS/UPPER DOOR

1. Disconnect electrical service. Remove contents from incubator chamber. Refer to Section 3.17 on controller removal.

2. Remove rear cover. Disconnect Connector J-9 from Power board. Remove the controller cable ground wire from the ground stud.

3. Remove the screws from the top cover. Remove 2 screws from each end of the fill/siphon port cover. See Figure 12. Slide the top cover forward about 1/2 inch to release it from the front of the enclosure. Lift top up and disconnect the sample port tubing. Remove top from unit.

4. Remove 2 screws from each end of the lower fill/siphon port cover. See Figure 13. Grasp each end of the cover and push it down to release the front edge from the upper splash cover. Lift cover out and remove sample port tubing.

5. Cut the 4 heater wires (including ground) about 3 inches below the lower door support for the upper chamber. See Figure 13. These wires will be used again.

6. Cut the controller cable near the upper door support bracket for the upper chamber. See Figure 15. Cut this wire only if you are replacing the door. Remove 4 nuts and bolts from the upper door support bracket. Lift bracket and door off unit.

7. Route new controller cable through upper door support bracket. Route the door heater wires through the lower door support bracket.

8. Place the door and upper door support bracket back on the unit. Make sure door is square with unit. Attach the upper door support bracket and tighten securely.

9. Cut the new door heater wires about 4 inches below the lower door support. Strip the ends about 3/8 inch. Connect one black wire from the new door heater to one of the original black wires with a wire nut. Repeat

this for the other set of black wires with another wire nut. Connect the 2 white wires together with another wire nut. Finally attach the 2 ground wires together with a wire nut. Secure the wires from physical damage.

10. There are adjustment points at the upper and lower door mounting brackets so that the outer door may be adjusted to close properly. The outer door gasket should contact the incubator body evenly on all four sides. If the door needs adjustment proceed as follows:

a. With a wrench, loosen the two nuts near the base of the lower door hinge. see Figure 14. Do not remove. This will allow adjustment of the lower section of the door. Adjust and tighten as necessary. Do not use excessive torque on these nuts.

b. Loosen the two nuts near the base of the upper door hinge. See Figure 15. This will allow adjustment of the upper section of the door. Adjust and tighten as necessary. Again, do not use excessive torque on these nuts.

11. Securely attach the end of the new controller cable to the end of the old controller cable and pull the old cable out from the back of the unit until the new cable appears.

12. Follow the instructions supplied with the door replacement kit for proper use of the installation tools for the 20 pin connector. Plug the connector back into J-9 on the Power board. Attach the ground wire to the ground stud.

13. Replace the top cover being sure to re-connect the sample tube. Replace the lower fill/siphon port cover being sure to re-connect the sample tubing. Replace the rear cover. Re-place the controller.

14. Test the unit for normal control function.

### 3.15 WATER JACKET CHAMBER MODULE

#### 3.15.1 SINGLE CHAMBER UNITS

1. Disconnect electrical service. Remove contents from incubator chamber. Remove the shelves. Drain water from water jacket. Refer to Section 3.1 on shelf support/blower duct removal, and remove supports and duct.

2. Remove rear cover. Remove the cartridge heater wires from Connector J-3. Disconnect Connectors J-4, J-10, J-11 (T/C CO2 sensor units) from Power board. Disconnect the CO2 sensor from the interface board (I/R CO2 units). Disconnect the ground wire from the fan motor plate. Disconnect the CO2 injection and sample port tubing from the fan motor plate. See Figs. 3, 6 & 7.

3. Remove the screws from the top cover. Remove 2 screws from each end of the fill/siphon port cover. See Fig. 14. Slide the top cover forward about 1/2 inch to release it from the front of the enclosure. Lift top up and disconnect the sample port tubing. Remove top from unit. Remove the insulation from the top of the chamber. Disconnect the auxiliary heater and float switch wires from the top of the chamber. See Figure 5.

4. Set the unit on its back. Use 3-inch thick support blocks to rest the unit on.

5. Cut the 4 heater wires (including ground) about 3 inches below the lower door support. See Figure 14. These wires will be used again.

6. Remove 4 nuts and bolts from the upper door support bracket. See Figure 15. Lift bracket and door off unit. Support the door so as not to damage the controller cable. Set the door off to the left side of the unit to allow clearance for chamber removal.

7. Remove glass door.

8. Remove the bolts that secure the splash cover/lower door support to the unit and remove. See Figure 13.

9. Remove the nuts (one left and one right) which secure the chamber bottom to the unit's exterior body. See Figure 14.

10. Remove the water jacket chamber module by sliding chamber out of the front of the exterior body. These chambers are awkward to handle and heavy. Another person to aid in removal is advised. If returning chamber to factory for repairs or replacement, remove the fan motor mounting bracket and float switch. These items will be used again.

11. Replace water jacket chamber module in reverse order of steps 6 through 10 above.

12. There are adjustment points at the upper and lower door mounting brackets so that the outer door may be adjusted to close properly. The outer door gasket should contact the incubator body evenly on all four sides. If the door needs adjustment proceed as follows:

a. With a wrench, loosen the two nuts near the base of the lower door hinge. See Figure 14. Do not remove. This will allow adjustment of the lower section of the door. Adjust and tighten as necessary. Do not use excessive torque on these nuts.

b. Loosen the two nuts near the base of the upper door hinge. See Figure 15. This will allow adjustment of the upper section of the door. Adjust and tighten as necessary. Again, do not use excessive torque on these nuts.

13. Strip the ends of the door heater wires about 3/8 inch. Connect one black wire from the door heater to one of the cut black wires with a wire nut. Repeat this for the other set of black wires with another wire nut. Connect the 2 white wires together with another wire nut. Finally attach the 2 ground wires together with a wire nut. secure the wires from physical damage.

14. Complete by reversing steps 1 through 4 of the above procedure.

### 3.15.2 DUAL CHAMBER UNITS/LOWER CHAMBER

1. Disconnect electrical service. Remove contents from incubator chamber. Remove the shelves. Drain water from water jacket. Refer to Section 3.1 on shelf support/blower duct removal, and remove supports and duct.

2. Remove rear cover. Remove the cartridge heater wires from Connector J-3. Disconnect Connectors J-4, J-10, J-11 (T/C CO2 sensor units) from Power board. Disconnect the CO2 sensor from the interface board (I/R CO2 units). Disconnect the ground wire from the fan motor plate. Disconnect the CO2 injection and sample port tubing from the fan motor plate. See Figs. 3, 6 & 7.

3. Remove 2 screws from each end of the lower fill/siphon port cover. See Figure 13. Grasp each end of the cover and push it down to release the front edge from the upper splash cover/door support. Lift cover out and remove sample port tubing. Remove the insulation from the top of the chamber. Disconnect the auxiliary heater and float switch wires from the top of the chamber. See Figure 5.

4. Set the unit on its back. Use 3-inch thick support blocks to rest the unit on.

5. Cut the 4 heater wires (including ground) about 3 inches below the lower door support. See Figure 14. These wires will be used again.

6. Remove 4 nuts and bolts from the upper door support bracket for the lower chamber. See Figure 13. Lift bracket and door off unit. Support the door so as not to damage the controller cable. Set the door off to the left side of the unit to allow clearance for chamber removal.

7. Remove glass door.

8. Remove the bolts that secure the splash cover/lower door support to the unit and remove. See Figure 13.

9. Remove the nuts (one left and one right) which secure the chamber bottom to the units exterior body. See Figure 14.
10. Remove the water jacket chamber module by sliding chamber out of the front of the exterior body. These chambers are awkward to handle and heavy. Another person to aid in removal is advised. If returning chamber to factory for repairs or replacement, remove the fan motor mounting bracket and float switch. These items will be used again.
11. Replace water jacket chamber module in reverse order of steps 6 through 10 above.
12. There are adjustment points at the upper and lower door mounting brackets so that the outer door may be adjusted to close properly. The outer door gasket should contact the incubator body evenly on all four sides. If the door needs adjustment proceed as follows:
  - a. With a wrench, loosen the two nuts near the base of the lower door hinge. See Figure 14. Do not remove. This will allow adjustment of the lower section of the door. Adjust and tighten as necessary. Do not use excessive torque on these nuts.
  - b. Loosen the two nuts near the base of the upper door hinge. See Figure 15. This will allow adjustment of the upper section of the door. Adjust and tighten as necessary. Again, do not use excessive torque on these nuts.
13. Strip the ends of the door heater wires about 3/8 inch. Connect one black wire from the door heater to one of the cut black wires with a wire nut. Repeat this for the other set of black wires with another wire nut. Connect the 2 white wires together with another wire nut. Finally attach the 2 ground wires together with a wire nut. Secure the wires from physical damage.
14. Complete by reversing steps 1 through 4 of the above procedure.

### 3.15.3 DUAL CHAMBER UNITS/UPPER CHAMBER

1. Disconnect electrical service. Remove contents from incubator chamber. Remove the shelves. Drain water from water jacket. Refer to Section 3.1 on shelf support/blower duct removal, and remove supports and duct.
2. Remove rear cover. Remove the cartridge heater wires from Connector J-3. Disconnect Connectors J-4, J-10, J-11 (T/C CO2 sensor units) from Power board. Disconnect the CO2 sensor from the interface board (I/R CO2 units). Disconnect the ground wire from the fan motor plate. Disconnect the CO2 injection and sample port tubing from the fan motor plate. See Figs. 3, 6 & 7.
3. Remove the screws from the top cover. Remove 2 screws from each end of the fill/siphon port cover. See Figure 12. Slide the top cover forward about 1/2 inch to release it from the front of the enclosure. Lift top up and disconnect the sample port tubing. Remove top from unit. Remove the insulation from the top of the chamber. Disconnect the auxiliary heater and float switch wires from the top of the chamber. See Figure 5.
4. Remove 2 screws from each end of the lower fill/siphon port cover. See Figure 13. Grasp each end of the cover and push it down to release the front edge from the upper splash cover/door support. Lift cover out and remove sample port tubing.
5. Cut the 4 heater wires (including ground) about 3 inches below the lower door support for the upper chamber. See Figure 13. These wires will be used again.
6. Remove 4 nuts and bolts from the upper door support bracket. See Figure 15. Lift bracket and door off unit. Support the door so as not to damage the controller cable. Set the door off to the left side of the unit to allow clearance for chamber removal.
7. Remove glass door.



8. Remove the bolts that secure the splash cover/lower door support to the unit and remove. See Figure 13.
9. Remove the nuts (one left and one right) which secure the chamber bottom to the unit's exterior body. See Figure 14.
10. Remove the water jacket chamber module by sliding the chamber out of the front of the exterior body. These chambers are awkward to handle and heavy. Another person to aid in removal is advised. If returning chamber to factory for repairs or replacement, remove the fan motor mousing backe and float switch. These items will be used again.
11. Replace water jacket chamber module in reverse order of steps 6 through 10 above.
12. There are adjustment points at the upper and lower door mounting brackets so that the outer door may be adjusted to close properly. The outer door gasket should contact th incubator body event on all four sides. If the door needs adjustment proceed as follows:
  - a. With a wrench, loosen the two nuts near the base of the lower door hinge. See Figure 14. Do not remove. This will allow adjustment of the lower section of th door. Adjst and tighten as necessary. Do not use excessive torque on these nuts.
  - b. Loosen the two nuts near the base of the upper door hinge. See Figure 15. This will alow adjustment of the upper section of the door. Ajust and tighten as necessary. Again, do not use excessive torque on these nuts.
13. Strip the ends of the door heater wires about 3/8 inch. Connect one black wire from the door heater to one of the cut black wires with a wire nut. Repeat this for the other set of black wires with another wire nut. Connect the 2 white wires together with another wire nut. Finally attach the 2 ground wires together with a wire nut. Secure the wires from phsical damage.
14. Complete by reversing steps 1 through 4 of the above procedure.

### 3.16 FUSES

1. Disconnect electrical service.
2. Pry the fuse holder out of the EMI filter.
3. Remove fuse(s) in question from fuse holder.
4. Locate source of fuse failure before replacing fuse(s).
5. Replace with new fuse(s) as required.
6. Press fuse holder back in place.

### 3.17 CONTROLLER BOARD ASSEMBLY

#### WARNING

*THE CONTROLLER CIRCUIT BOARD CAN BE EASILY DAMAGED BY STATIC ELECTRICITY. OBSERVE ALL RULES CONCERNING THE PROPER HANDLING OF STATIC SENSITIVE DEVICES. GROUND YOURSELF TO A KNOWN EARTH GROUNDED METAL OBJECT IMMEDIATELY BEFORE HANDLING STATIC SENSITIVE EQUIPMENT.*

1. Disconnect electrical service.
2. Open the door and remove 2 screws from the top of the control module. Slide the controller up and at the same time press the locking tab in to release the panel. Slide the controller out of the door. See Figure 2. It is best to wrap or lay the board(s) in anti-static bags when handling them out of the door. Many components used are static sensitive and can be easily damaged.
3. Before replacing the controller assembly, check to see that jumper JP-1 is set to the "OUT" position. JP- 1 is located above U-2. Next, jumper JP-2 on the controller must be configured properly for use with either a T/C type CO<sub>2</sub> sensor (Models 5, 5H, 10 or 10), or for use with an I/R type CO<sub>2</sub> sensor (Models 51, 51H, 101 or 101H). JP-2 is located above

- U-2. Finally check that jumper JP-3 is set to the "OUT" position. JP-3 is located to the left of U-2. See Figure 1.
4. While holding the locking tab, slide the controller into the door. Be sure the guides on the control panel are engaged into the door properly. Push the locking tab back toward the circuit board so that the controller can be engaged into the edge card connector. The locking tab should now spring forward and be held captive by the stud on the rear of the control panel.
  5. Replace the controller screws.
  6. Remove the CO<sub>2</sub> solenoid and bracket assembly from the board. It will be used on the replacement board.
  7. Replace power circuit board in reverse order of above procedure.

**NOTE**

*EVEN THOUGH REPLACEMENT POWER BOARDS ARE PRE-CALIBRATED AT THE FACTORY, IT IS RECOMMENDED THE POWER BOARD VOLTAGES BE CHECKED AND ADJUSTED AS REQUIRED. REFER TO SECTION 2.3 REGARDING POWER BOARD CALIBRATION.*

**3.18 POWER CIRCUIT BOARD**

**NOTE**

*VOLTAGE SELECT JUMPERS FOR TRANSFORMER AND HEATERS MUST BE PROPERLY SELECTED BEFORE ENERGIZING POWER BOARD. FAILURE TO DO SO MAY DAMAGE POWER BOARD AND/OR CONTROLLER BOARD.*

1. Disconnect electrical service.
2. Remove rear cover.
3. Disconnect Connectors J-1, J-2 J-3, J-4, J-8, J-9 J-10 & J-11 from the power circuit board. Remove the wires from Connectors J-5 & J-7. Remove ground wire to chassis. See Figures 3 & 6.
4. Remove the mounting screws from the power circuit board. The power circuit board may now be removed from the unit.
5. Select the proper transformer tap and voltage select taps on the Power board. Select the appropriate CO<sub>2</sub> sensor type used on your incubator by configuring the IR/TC jumper. Refer to Figure 3.

**3.19 TRANSFORMER**

1. Disconnect electrical service.
2. Remove rear cover.
3. Disconnect Connector J-1 from the power circuit board. See Figure 3.
4. Remove the mounting screws from the transformer.
5. Remove the connector from the old transformer carefully noting the location of each wire. The connector will be used on the replacement transformer.
6. Replace transformer in reverse order of above procedure.

**3.20 EMI FILTER**

1. Disconnect electrical service.
2. Remove rear cover.
3. Disconnect the wires from the EMI filter.
4. Remove the mounting screws from the EMI filter and remove filter. Remove the fuses from the old EMI filter. They will be used again.
5. Replace the EMI filter in reverse order of above procedure.

### 3.21 REPLACEMENT PARTS LISTS

MODEL 5 (110/120 VOLTS - 50/60 Hz.)

DESCRIPTION	PART NO.	STD. QTY.
Foot Levelers .....	241077 .....	4
Power Board Fuse; 3/8 Amp .....	101408009 .....	1
Fuse: 5 AMP (5 X 20mm) .....	289114 .....	2
Blower Duct (Air Plenum) .....	102625010 .....	1
EMI/RFI Filter .....	101432011 .....	1
Door Heater .....	247426 .....	1
Air Heater .....	247431 .....	1
Cartridge Heater .....	143304100 .....	2
Chamber Heater (Outer Top) .....	247423 .....	1
Fan Motor .....	223720 .....	1
Solenoid Valve .....	297047 .....	1
Limiting Thermostat .....	239190 .....	1
Power Transformer .....	105039087 .....	1
T/C CO <sub>2</sub> Sensor Assembly .....	105028030 .....	1
Temperature Sensor Assembly .....	105028031 .....	1
Blower Wheel .....	1402-020 .....	1
Shelf Slides .....	102660011 .....	12
CO <sub>2</sub> Filter (External) .....	102013005 .....	1
CO <sub>2</sub> Filter (Internal) .....	310128 .....	1
Power Board Assembly .....	00374701 .....	1
Control Board Assembly .....	00374902 .....	1
Glass Door .....	330260 .....	1
Glass Door Assembly .....	107002003 .....	1
Float Switch Assembly .....	105013039 .....	1
Power Cord .....	353025 .....	1
Shelf .....	102644010 .....	5
Water Fill Hose .....	108001004 .....	1
HEPA Gas Filter .....	542575 .....	1
Phone Plug, 1/4" (CMS) .....	1418-040 .....	1
Humidity Tray .....	102633001 .....	1

## REPLACEMENT PARTS LIST

MODEL 5H (110/120 VOLTS -50/60 Hz.)

DESCRIPTION	PART NO.	STD. QTY.
Foot Levelers.....	241077.....	4
Power Board Fuse; 3/8 Amp.....	101408009.....	1
Fuse: AMP (5 X 20mm).....	289114.....	2
Blower Duct (Air Plenum).....	102625010.....	1
EMI/RFI Filter.....	101432011.....	1
Door Heater.....	247426.....	1
Air Heater.....	247431.....	1
Cartridge Heater.....	143304100.....	2
Chamber Heater (Outer Top).....	247423.....	1
Fan Motor.....	223720.....	1
Solenoid Valve.....	297047.....	1
Limiting Thermostat.....	239190.....	1
Power Transformer.....	105039087.....	1
T/C CO <sub>2</sub> Sensor/PC Board Assembly.....	105028030.....	1
Temperature Sensor Assembly.....	105028031.....	1
Blower Wheel.....	1402-020.....	1
Shelf Slides.....	102660011.....	12
CO <sub>2</sub> Filter (External).....	102013005.....	1
CO <sub>2</sub> Filter (Internal).....	310128.....	1
Power Board Assembly.....	00374701.....	1
Control Panel Assembly.....	00374901.....	1
Glass Door.....	330260.....	1
Glass Door Assembly.....	107002003.....	1
Float Switch Assembly.....	105013039.....	1
Power Cord.....	353025.....	1
Shelf.....	102644010.....	5
Water Fill Hose.....	108001004.....	1
HEPA Gas Filter Kit.....	542575.....	1
Phone Plug, 1/4" (CMS).....	1418-040.....	1
Relative Humidity Sensor Assembly.....	541951.....	1
Humidity Tray.....	102633001.....	1

REPLACEMENT PARTS LISTS

MODEL 51 (110/120 VOLTS - 50/60 Hz.)

DESCRIPTION	PART NO.	STD. QTY.
Foot Levelers.....	241077.....	4
Power Board Fuse; 3/8 Amp.....	101408009.....	1
Fuse: 5 AMP (5 X 20mm).....	289114.....	2
Blower Duct (Air Plenum).....	102625010.....	1
EMI/RFI Filter.....	101432011.....	1
Door Heater.....	247426.....	1
Air Heater.....	247431.....	1
Cartridge Heater.....	143304100.....	2
Chamber Heater (Outer Top).....	247423.....	1
Fan Motor.....	223720.....	1
Solenoid Valve.....	297047.....	1
Limiting Thermostat.....	239190.....	1
Power Transformer.....	105039087.....	1
I/R CO <sub>2</sub> Sensor/PC Board Assembly.....	102204101.....	1
Temperature Sensor Assembly.....	105028031.....	1
Blower Wheel.....	1402-020.....	1
Shelf Slides.....	102660011.....	12
CO <sub>2</sub> Filter (External).....	102013005.....	1
CO <sub>2</sub> Filter (Internal).....	310128.....	1
Power Board Assembly.....	00374701.....	1
Control Board Assembly.....	00374902.....	1
Glass Door.....	330260.....	1
Glass Door Assembly.....	107002003.....	1
Float Switch Assembly.....	105013039.....	1
Power Cord.....	353025.....	1
Shelf.....	102644010.....	5
Water Fill Hose.....	108001004.....	1
HEPA Gas Filter.....	542575.....	1
Phone Plug, 1/4" (CMS).....	1418-040.....	1
Humidity Tray.....	102633001.....	1

REPLACEMENT PARTS LIST

MODEL 51H (110/120 VOLTS -50/60 Hz.)

DESCRIPTION	PART NO.	STD. QTY.
Foot Levelers .....	241077 .....	4
Power Board Fuse; 3/8 Amp .....	101408009 .....	1
Fuse: 5 AMP (5 X 20mm) .....	289114 .....	2
Blower Duct (Air Plenum) .....	102625010 .....	1
EMI/RFI Filter .....	101432011 .....	1
Door Heater .....	247426 .....	1
Air Heater .....	247431 .....	1
Cartridge Heater .....	143304100 .....	2
Chamber Heater (Outer Top) .....	247423 .....	1
Fan Motor .....	223720 .....	1
Solenoid Valve .....	297047 .....	1
Limiting Thermostat .....	239190 .....	1
Power Transformer .....	105039087 .....	1
I/R CO <sub>2</sub> Sensor/PC Board Assembly .....	102204101 .....	1
Temperature Sensor Assembly .....	105028031 .....	1
Blower Wheel .....	1402-020 .....	1
Shelf Slides .....	102660011 .....	12
CO <sub>2</sub> Filter (External) .....	102013005 .....	1
CO <sub>2</sub> Filter (Internal) .....	310128 .....	1
Power Board Assembly .....	00374701 .....	1
Control Panel Assembly .....	00374901 .....	1
Glass Door .....	330260 .....	1
Glass Door Assembly .....	107002003 .....	1
Float Switch Assembly .....	105013039 .....	1
Power Cord .....	353025 .....	1
Shelf .....	102644010 .....	5
Water Fill Hose .....	108001004 .....	1
HEPA Gas Filter Kit .....	542575 .....	1
Phone Plug, 1/4" (CMS) .....	1418-040 .....	1
Relative Humidity Sensor Assembly .....	541951 .....	1
Humidity Pan Kit .....	102633001 .....	1

## REPLACEMENT PARTS LISTS

MODEL 10 (110/120 VOLTS - 50/60 Hz.)

DESCRIPTION	PART NO.	STD. QTY.
Foot Levelers .....	241077 .....	4
Power Board Fuse; 3/8 Amp .....	101408009 .....	2
Fuse: 5 AMP (5 X 20mm) .....	289114 .....	2
Blower Duct (Air Plenum) .....	102625010 .....	2
EMI/RFI Filter .....	101432011 .....	1
Door Heater .....	247426 .....	2
Air Heater .....	247431 .....	2
Cartridge Heater .....	143304100 .....	4
Chamber Heater (Outer Top) .....	247423 .....	2
Fan Motor .....	223720 .....	2
Solenoid Valve .....	297047 .....	2
Limiting Thermostat .....	239190 .....	2
Power Transformer .....	105039087 .....	2
T/C CO <sub>2</sub> Sensor/PC Board Assembly .....	105028030 .....	2
Temperature Sensor Assembly .....	105028031 .....	2
Blower Wheel .....	1402-020 .....	2
Shelf Slides .....	102660011 .....	24
CO <sub>2</sub> Filter (External) .....	102013005 .....	1
CO <sub>2</sub> Filter (Internal) .....	310128 .....	1
Power Board Assembly .....	00374701 .....	2
Control Board Assembly .....	00374902 .....	2
Glass Door .....	330260 .....	2
Glass Door Assembly .....	107002003 .....	2
Float Switch Assembly .....	105013039 .....	2
Power Cord .....	353025 .....	1
Shelf .....	102644010 .....	10
Water Fill Hose .....	108001004 .....	1
HEPA Gas Filter .....	542575 .....	1
Phone Plug, 1/4" (CMS) .....	1418-040 .....	2
Humidity Tray .....	102633001 .....	2

## REPLACEMENT PARTS LISTS

MODEL 10H (110/120 VOLTS - 50/60 Hz.)

DESCRIPTION	PART NO.	STD. QTY.
Foot Levelers .....	241077 .....	4
Power Board Fuse; 3/8 Amp .....	101408009 .....	2
Fuse: 5 AMP (5 X 20mm) .....	289114 .....	2
Blower Duct (Air Plenum) .....	102625010 .....	2
EMI/RFI Filter .....	101432011 .....	1
Door Heater .....	247426 .....	2
Air Heater .....	247431 .....	2
Cartridge Heater .....	143304100 .....	4
Chamber Heater (Outer Top) .....	247423 .....	2
Fan Motor .....	223720 .....	2
Solenoid Valve .....	297047 .....	2
Limiting Thermostat .....	239190 .....	2
Power Transformer .....	105039087 .....	2
T/C CO <sub>2</sub> Sensor/PC Board Assembly .....	105028030 .....	2
Temperature Sensor Assembly .....	105028031 .....	2
Blower Wheel .....	1402-020 .....	2
Shelf Slides .....	102660011 .....	24
CO <sub>2</sub> Filter (External) .....	102013005 .....	1
CO <sub>2</sub> Filter (Internal) .....	310128 .....	1
Power Board Assembly .....	00374701 .....	2
Control Board Assembly .....	00374901 .....	2
Glass Door .....	330260 .....	2
Glass Door Assembly .....	107002003 .....	2
Float Switch Assembly .....	105013039 .....	2
Power Cord .....	353025 .....	1
Shelf .....	102644010 .....	10
Water Fill Hose .....	108001004 .....	1
HEPA Gas Filter .....	542575 .....	1
Phone Plug, 1/4" (CMS) .....	1418-040 .....	2
Relative Humidity Sensor Assembly .....	541951 .....	2
Humidity Tray .....	102633001 .....	2



REPLACEMENT PARTS LISTS

MODEL 101 (110/120 VOLTS - 50/60 Hz.)

DESCRIPTION	PART NO.	STD. QTY.
Foot Levelers .....	241077 .....	4
Power Board Fuse; 3/8 Amp .....	101408009 .....	2
Fuse: 5 AMP (5 X 20mm) .....	289114 .....	2
Blower Duct (Air Plenum) .....	102625010 .....	2
EMI/RFI Filter .....	101432011 .....	1
Door Heater .....	247426 .....	2
Air Heater .....	247431 .....	2
Cartridge Heater .....	143304100 .....	4
Chamber Heater (Outer Top) .....	247423 .....	2
Fan Motor .....	223720 .....	2
Solenoid Valve .....	297047 .....	2
Limiting Thermostat .....	239190 .....	2
Power Transformer .....	105039087 .....	2
I/R CO <sub>2</sub> Sensor/PC Board Assembly .....	102204101 .....	2
Temperature Sensor Assembly .....	105028031 .....	2
Blower Wheel .....	1402-020 .....	2
Shelf Slides .....	102660011 .....	24
CO <sub>2</sub> Filter (External) .....	102013005 .....	1
CO <sub>2</sub> Filter (Internal) .....	310128 .....	1
Power Board Assembly .....	00374701 .....	2
Control Board Assembly .....	00374902 .....	2
Glass Door .....	330260 .....	2
Glass Door Assembly .....	107002003 .....	2
Float Switch Assembly .....	105013039 .....	2
Power Cord .....	353025 .....	1
Shelf .....	102644010 .....	10
Water Fill Hose .....	108001004 .....	1
HEPA Gas Filter .....	542575 .....	1
Phone Plug, 1/4" (CMS) .....	1418-040 .....	2
Humidity Tray .....	102633001 .....	2

REPLACEMENT PARTS LISTS

MODEL 101H (110/120 VOLTS - 50/60 Hz.)

DESCRIPTION	PART NO.	STD. QTY.
Foot Levelers .....	241077 .....	4
Power Board Fuse; 3/8 Amp .....	101408009 .....	2
Fuse: 5 AMP (5 X 20mm) .....	289114 .....	2
Blower Duct (Air Plenum) .....	102625010 .....	2
EMI/RFI Filter .....	101432011 .....	1
Door Heater .....	247426 .....	2
Air Heater .....	247431 .....	2
Cartridge Heater .....	143304100 .....	4
Chamber Heater (Outer Top) .....	247423 .....	2
Fan Motor .....	223720 .....	2
Solenoid Valve .....	297047 .....	2
Limiting Thermostat .....	239190 .....	2
Power Transformer .....	105039087 .....	2
I/R CO <sub>2</sub> Sensor/PC Board Assembly .....	102204101 .....	2
Temperature Sensor Assembly .....	105028031 .....	2
Blower Wheel .....	1402-020 .....	2
Shelf Slides .....	102660011 .....	24
CO <sub>2</sub> Filter (External) .....	102013005 .....	1
CO <sub>2</sub> Filter (Internal) .....	310128 .....	1
Power Board Assembly .....	00374701 .....	2
Control Board Assembly .....	00374901 .....	2
Glass Door .....	330260 .....	2
Glass Door Assembly .....	107002003 .....	2
Float Switch Assembly .....	105013039 .....	2
Power Cord .....	353025 .....	1
Shelf .....	102644010 .....	10
Water Fill Hose .....	108001004 .....	1
HEPA Gas Filter .....	542575 .....	1
Phone Plug, 1/4" (CMS) .....	1418-040 .....	2
Relative Humidity Sensor Assembly .....	541951 .....	2
Humidity Tray .....	102633001 .....	2

**PART 4**  
**ILLUSTRATIONS, FIGURES AND SCHEMATICS**

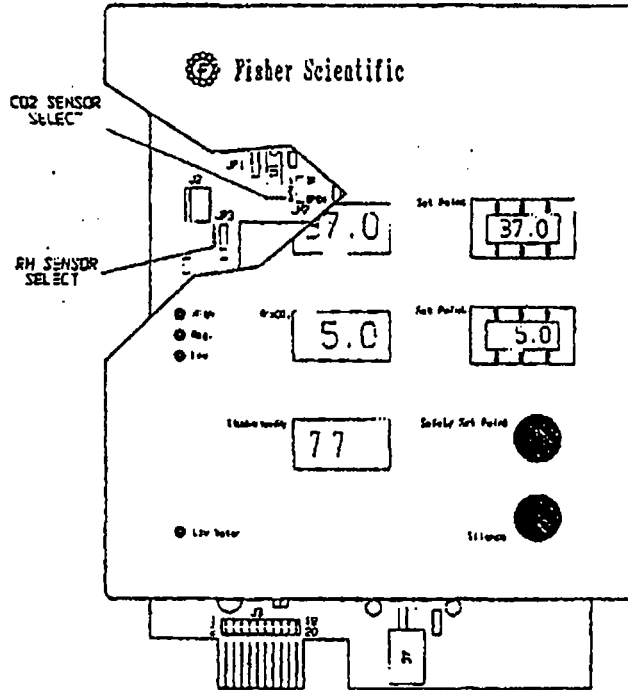

**Figure 1. Control Panel.**

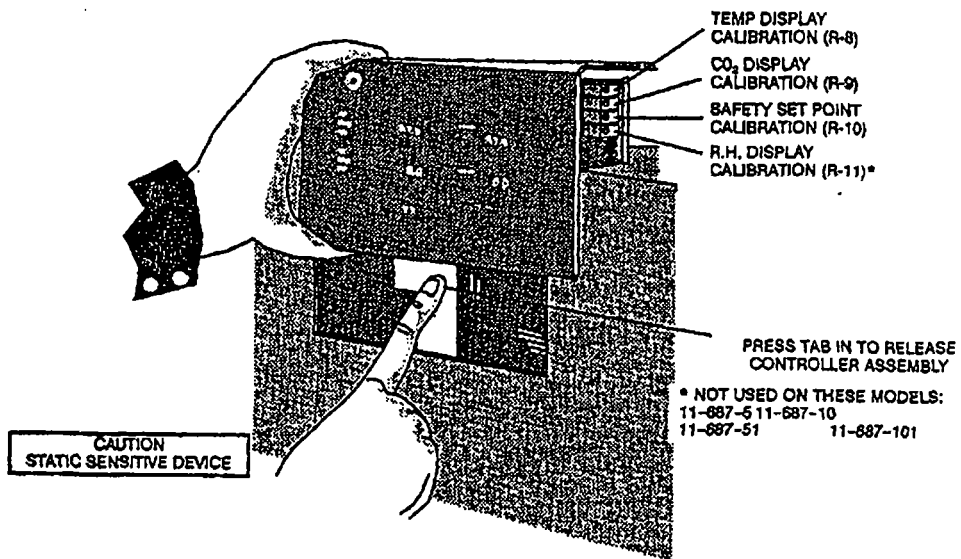

**Figure 2. Controller Board Removal.**

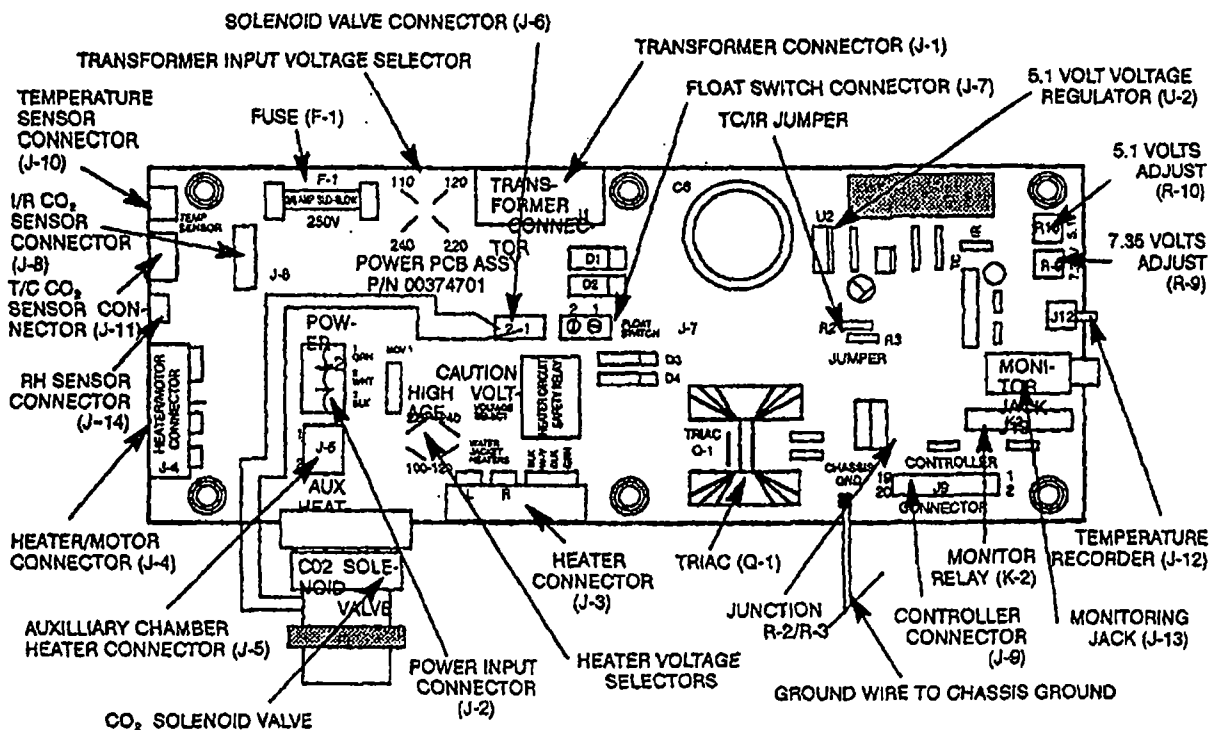

Figure 3. Power Circuit Board.

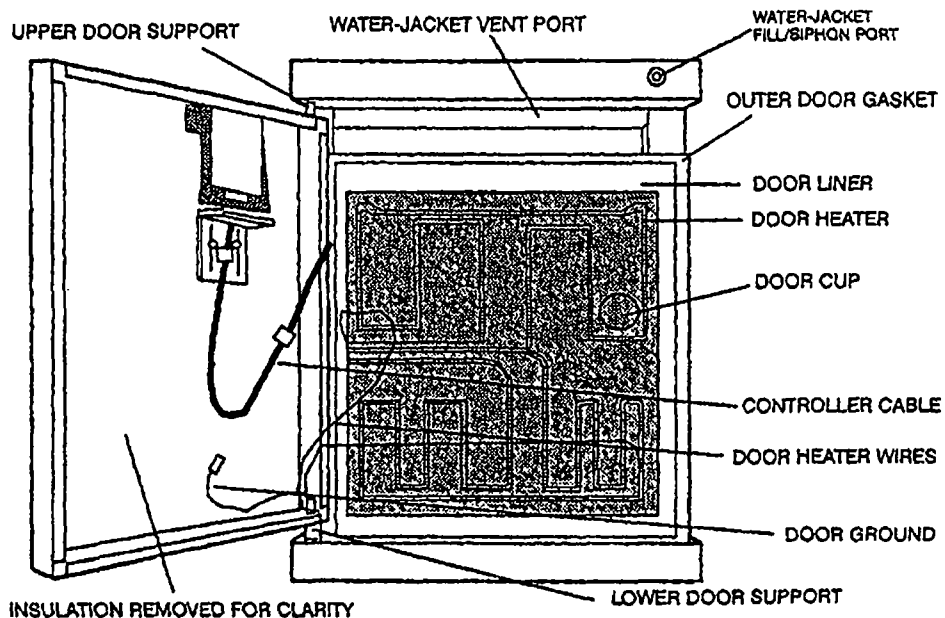

Figure 4. Door Heater and Attaching Components.

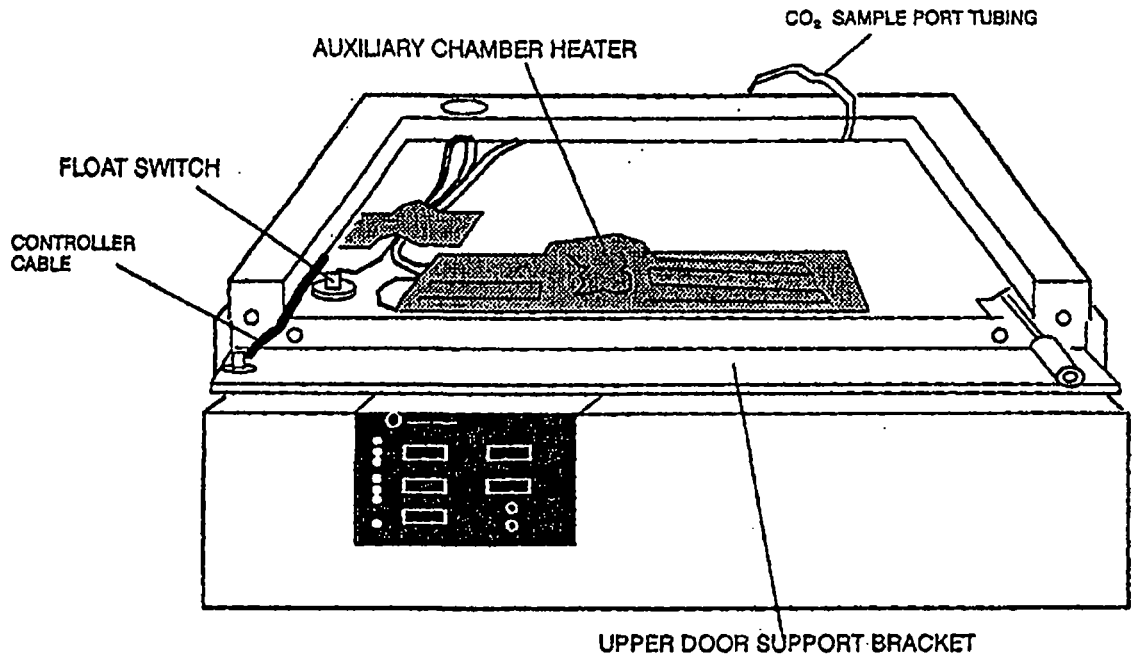

Figure 5. Top Cover Removed.

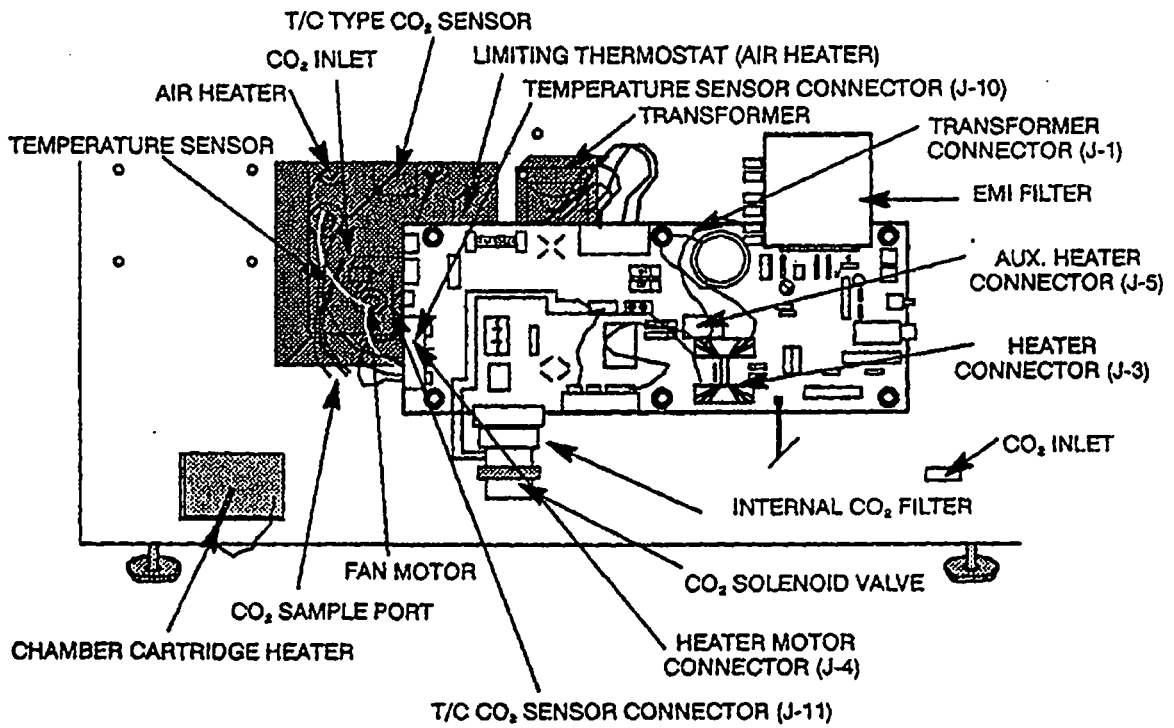

Figure 6. Rear View - Cover Removed.

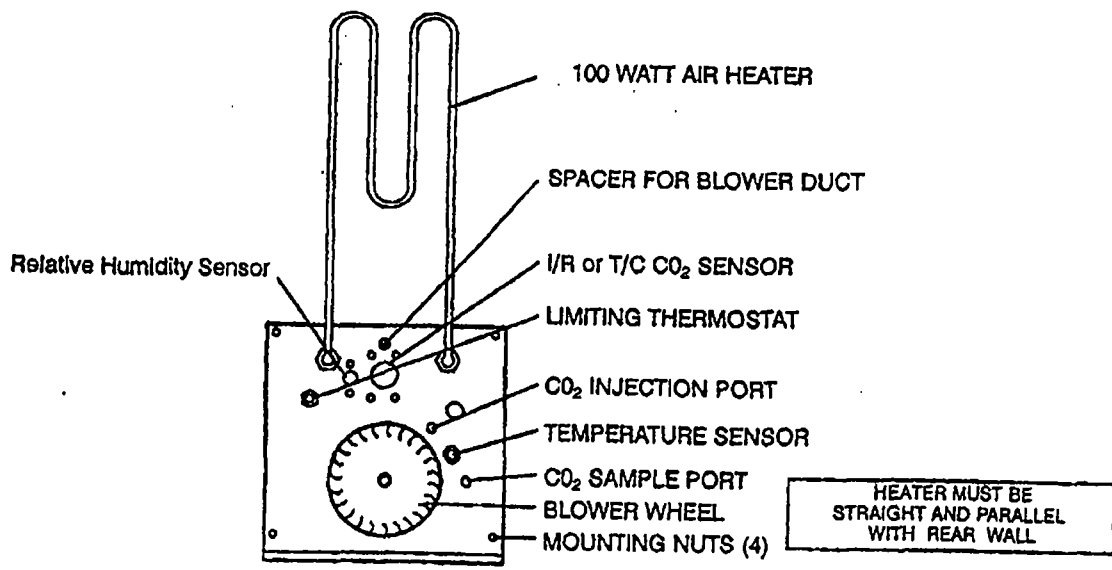

Figure 7. Fan Motor Plate.

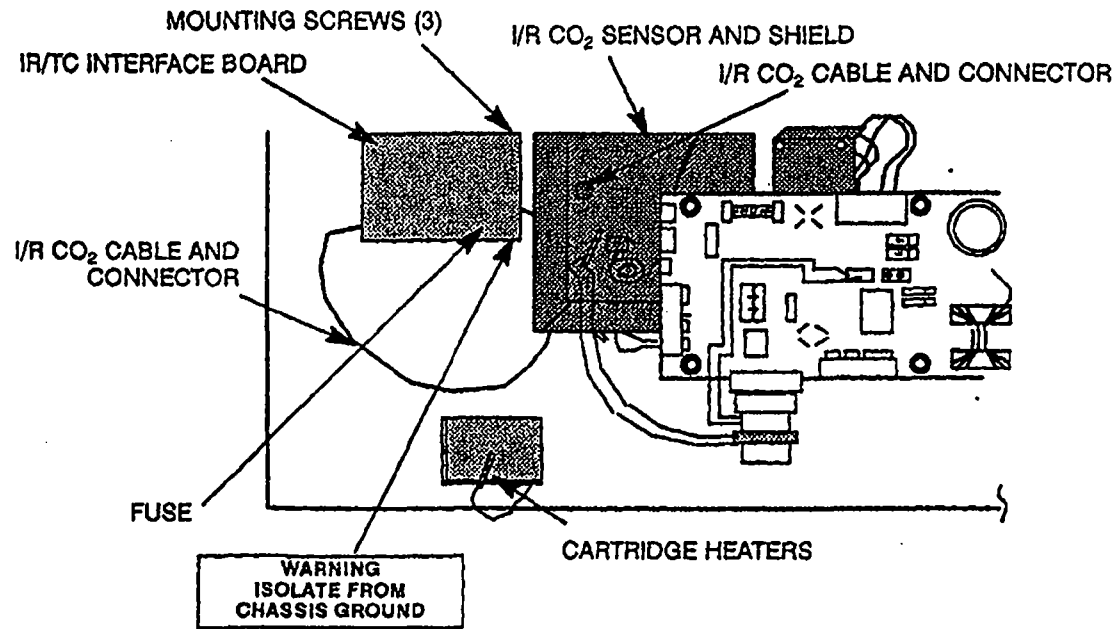
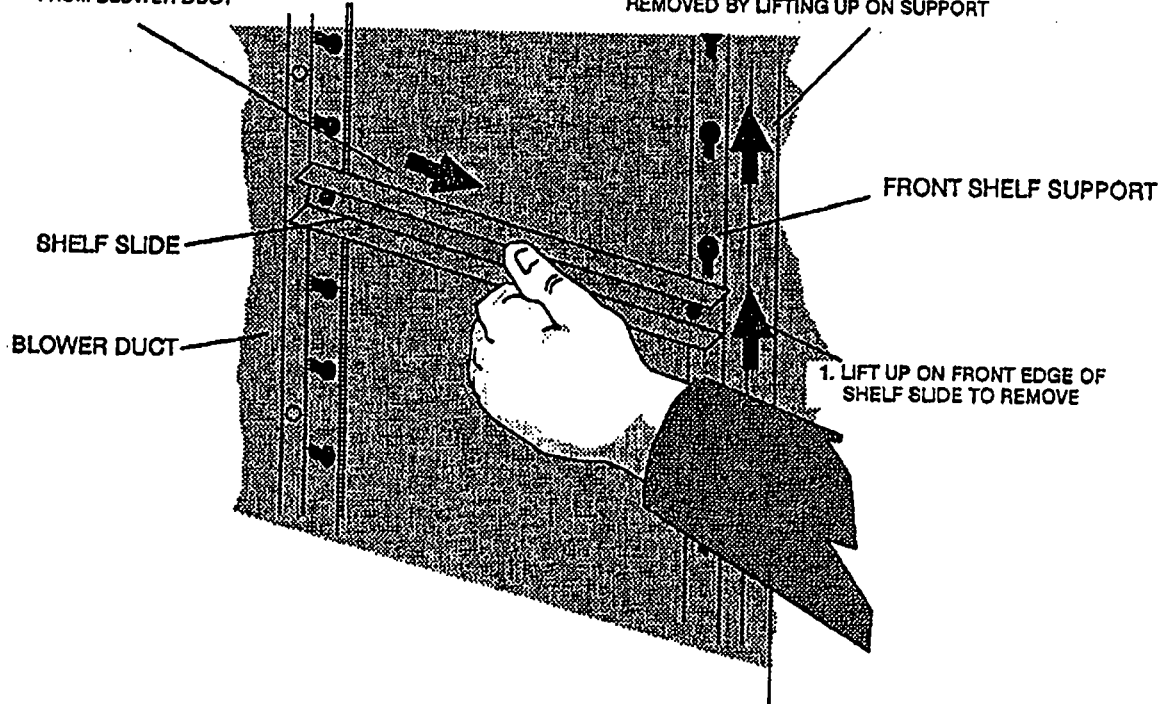

Figure 8. I/R Interface Board and Related Components.

2. PULL ON SHELF SLIDE TO DISENGAGE FROM BLOWER DUCT

3. FRONT SHELF SUPPORTS CAN NOW BE REMOVED BY LIFTING UP ON SUPPORT



1. LIFT UP ON FRONT EDGE OF SHELF SLIDE TO REMOVE

Figure 9. Shelf Slide Removal.

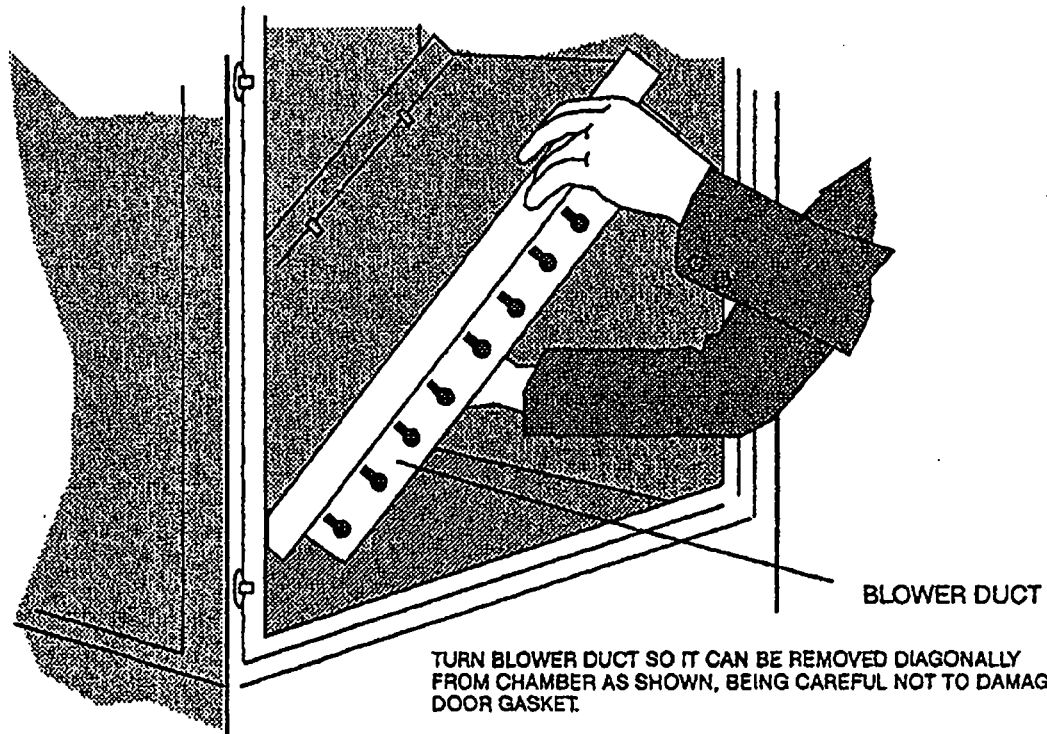

Figure 10. Blower Duct Removal.

HORIZONTAL KEYWAY  
PLACE TOWARD BACK OF CHAMBER

VERTICAL KEYWAY  
PLACE TOWARD FRONT OF CHAMBER

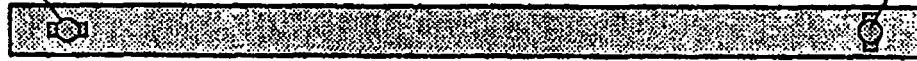

Figure 11. Shelf Slide.

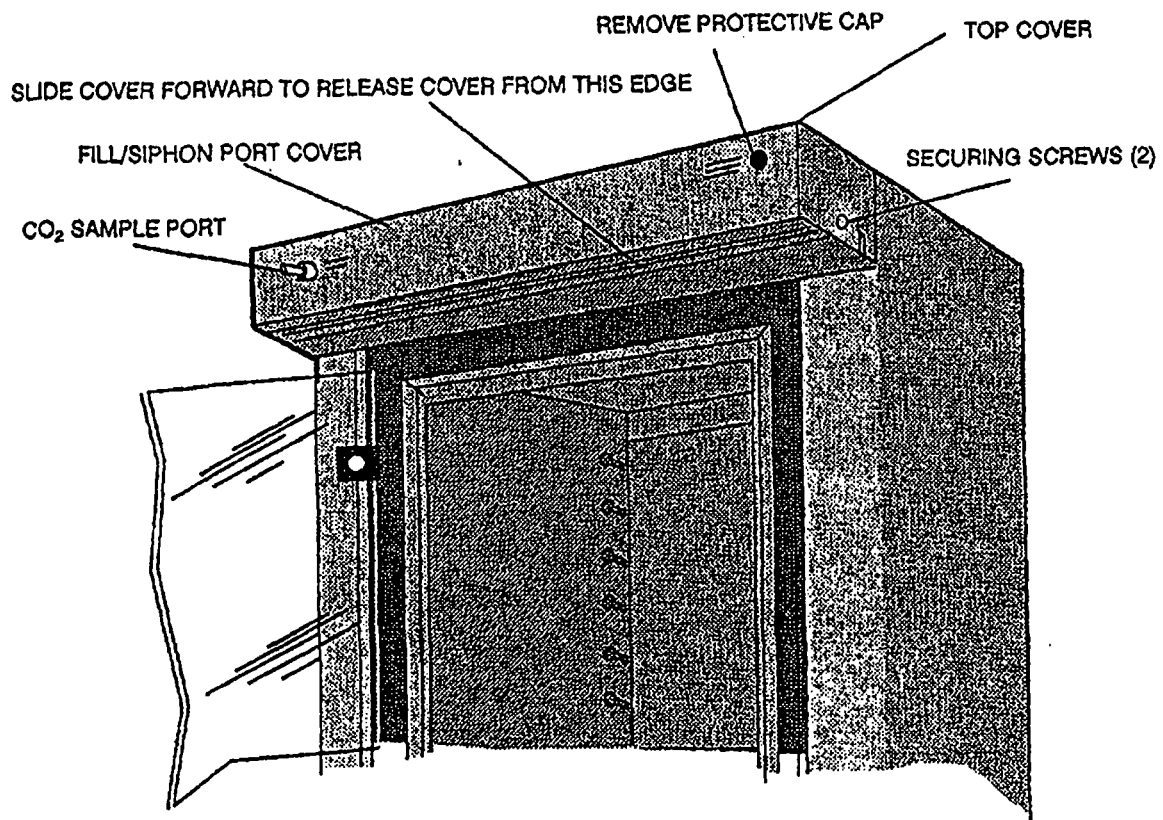

Figure 12. Top Cover Removal.



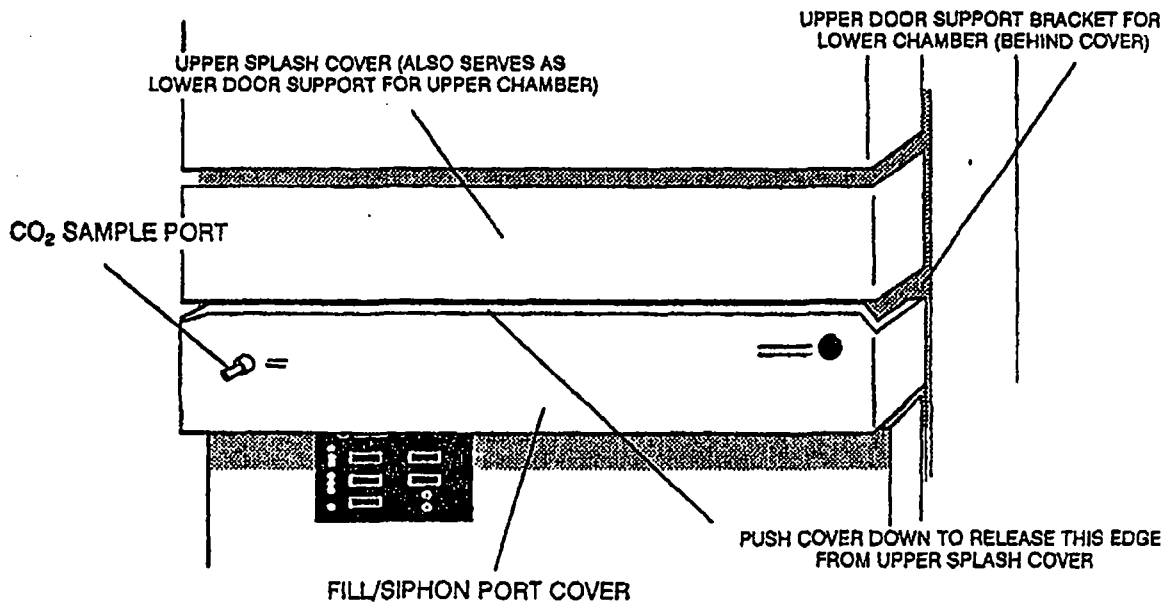

Figure 13. Dual Chamber Units – Fill/Siphon Port Cover Removal.

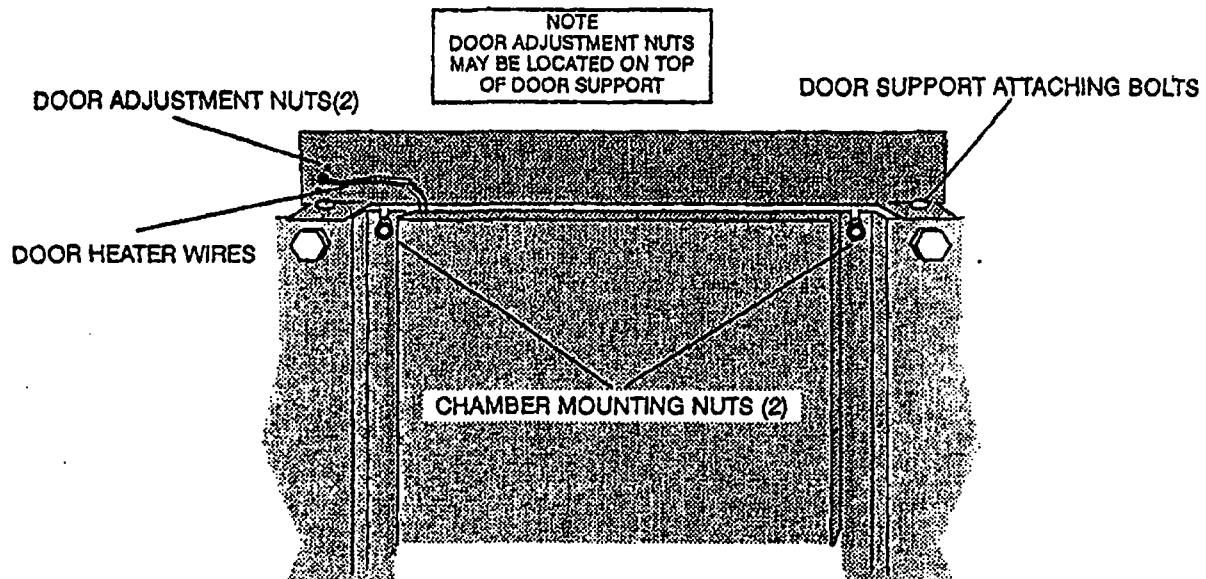
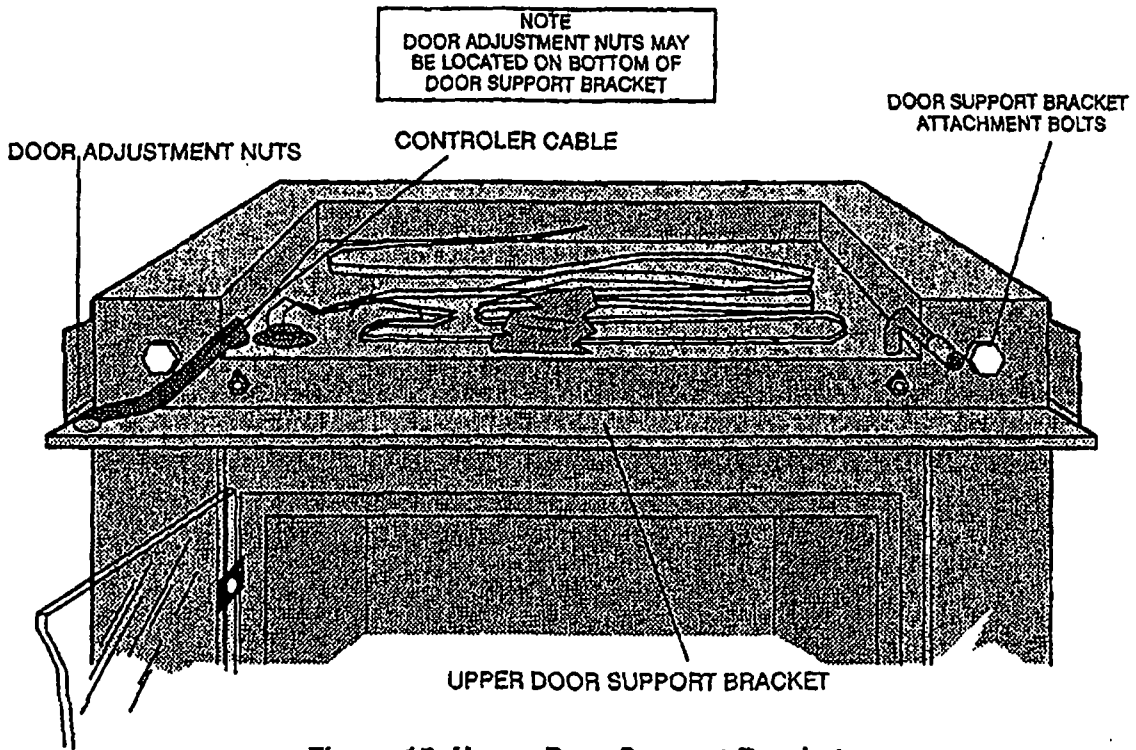

Figure 14. Lower Door Support.



**Figure 15. Upper Door Support Bracket.**

NOTE: 1. COMPARE JUMPERS ON POWER BOARD WITH LINE VOLTAGE.  
2. REFER TO MODEL NUMBER FOR UNITS OPTION.

--- 100VAC = YEL  
120VAC = WHT  
220/240VAC = BLK

AUXILIARY HEATER  
(OPTIONAL)  
RELATIVE HUMIDITY SENSOR

FLUENT SW  
LIMITING THERMOSTAT  
FAN MOTOR  
MOTOR LEADS  
• 100/120VAC = BLK  
220/240VAC = WHT/RED

TEMP SENSOR  
TC CO<sub>2</sub> SENSOR

1/2 CO<sub>2</sub> SENSOR (OPTIONAL)  
1/2 CO<sub>2</sub> PCB

TRANSFORMER  
120VAC  
220VAC  
240VAC

LINE VOLTAGE SELECT

CONTROL PCB (LOWER)

ODOR HEATER

DIFFUSER HEATERS

--- 100VAC = YEL  
120VAC = WHT  
220/240VAC = BLK

AUXILIARY HEATER  
(OPTIONAL)  
RELATIVE HUMIDITY SENSOR

FLUENT SW  
LIMITING THERMOSTAT  
FAN MOTOR  
MOTOR LEADS  
• 100/120VAC = BLK  
220/240VAC = WHT/RED

TEMP SENSOR  
TC CO<sub>2</sub> SENSOR

1/2 CO<sub>2</sub> SENSOR (OPTIONAL)  
1/2 CO<sub>2</sub> PCB

TRANSFORMER  
120VAC  
220VAC  
240VAC

LINE VOLTAGE SELECT

CONTROL PCB (UPPER)

ODOR HEATER

CARTRIDGE HEATERS

--- 100VAC = YEL  
120/240VAC = WHT

FLUENT SW  
F. 857000  
100/120VAC = 30 AMP 250 VOLT 50.0 HZ  
200/240VAC = 15 AMP 250 VOLT 50.0 HZ  
D.C. FILTER  
WHT (NEUTRAL)  
GRN/YEL (GROUND)  
D.C. 60V 500V

WIRING DIAGRAM  
(P/N 541950)